

PEAKTOP
Outdoor Tulip Kinetic Solar Light
Windmill-Teal
3016386

TIME SAVER!
3D Interactive Instruction

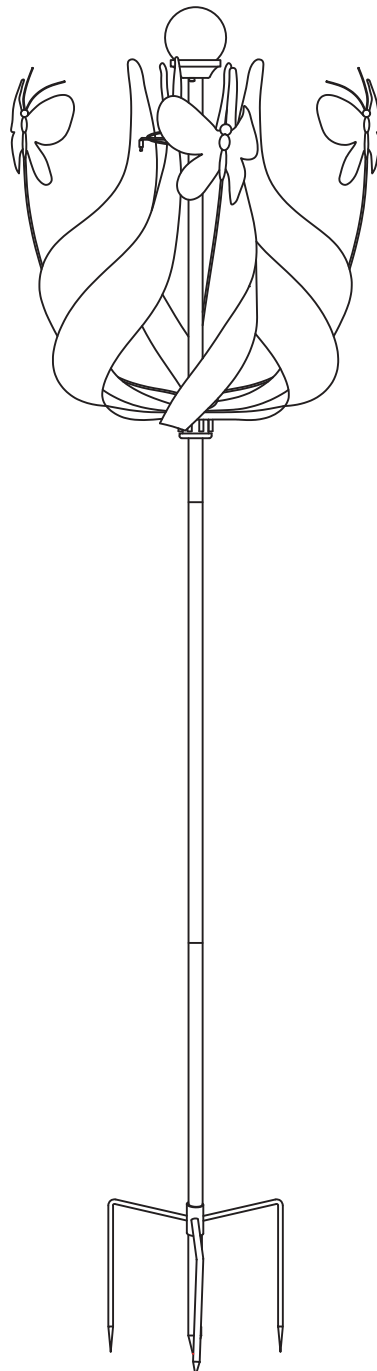

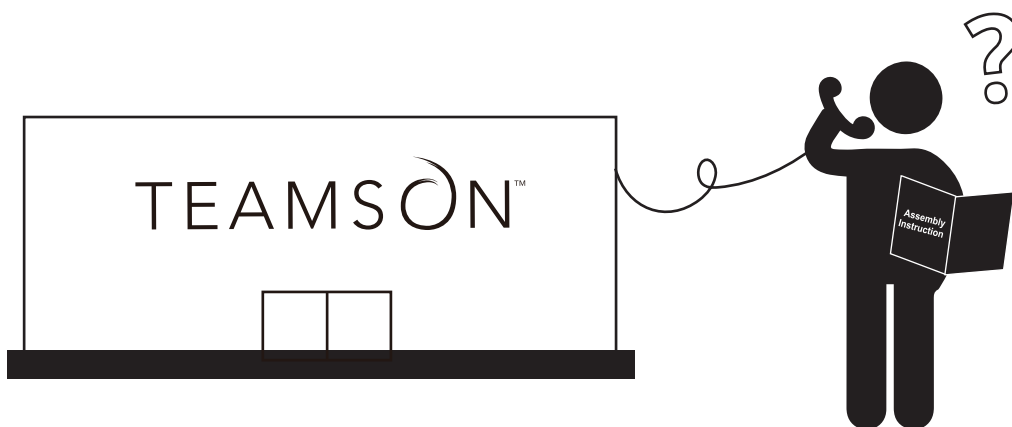
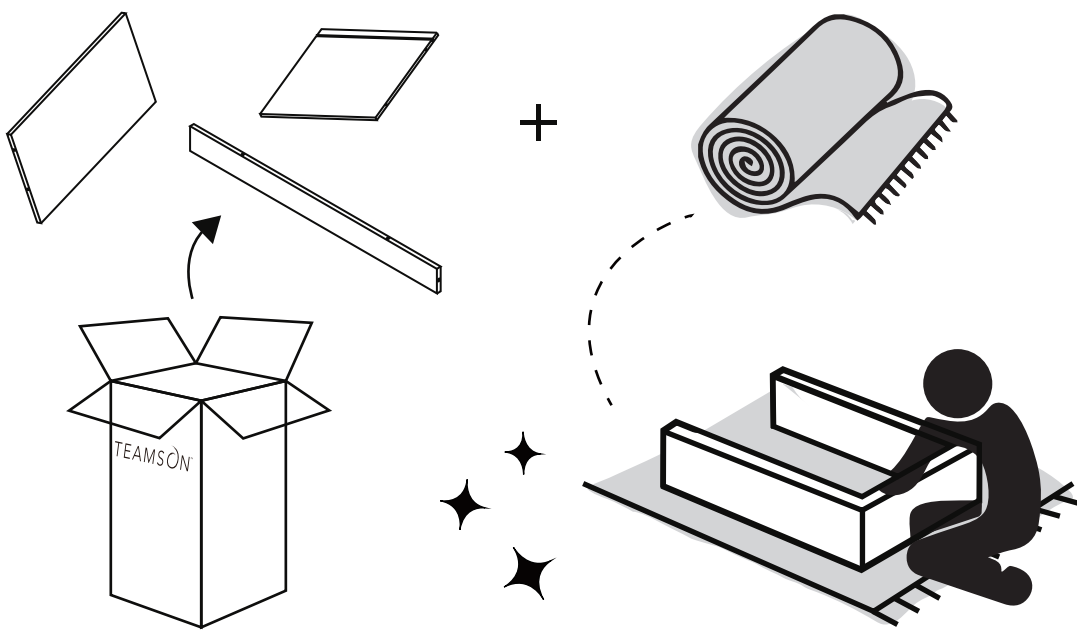
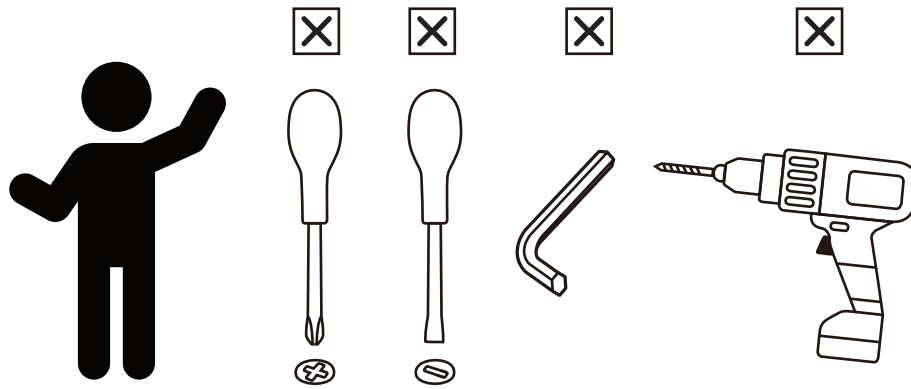

** Got questions? Please have your product code (on the first page of this instruction, e.g. 3016386) and the order number ready, give us a call or email us through our customer care support! We are always ready to assist you!

TEAMSON HOME



3D Interactive Instruction

www.teamsonhome.com

Serving you well gives us great joy!

USA +1(800)935-3959

Mon - Fri 10:00am ~ 2:00pm EST

✉ support@teamson.com

EU +44(0)1952-916-050

Mon - Thu 9:00am ~ 5:00pm GMT

Friday 9:00am ~ 4:00pm GMT

✉ support@teamson.co.uk

ASIA 深圳办公室:

+86(0755)8885-3558.分机号331

Mon - Sat 9:00am ~ 5:00pm GMT+8

✉ sales_ec@teamson.com

台北办公室:

+886(2)2556-6268

Mon - Fri 9:00am ~ 5:00pm GMT+8

✉ sales_ec@teamson.com

Thank you for choosing Teamson Home

Exploded Drawing

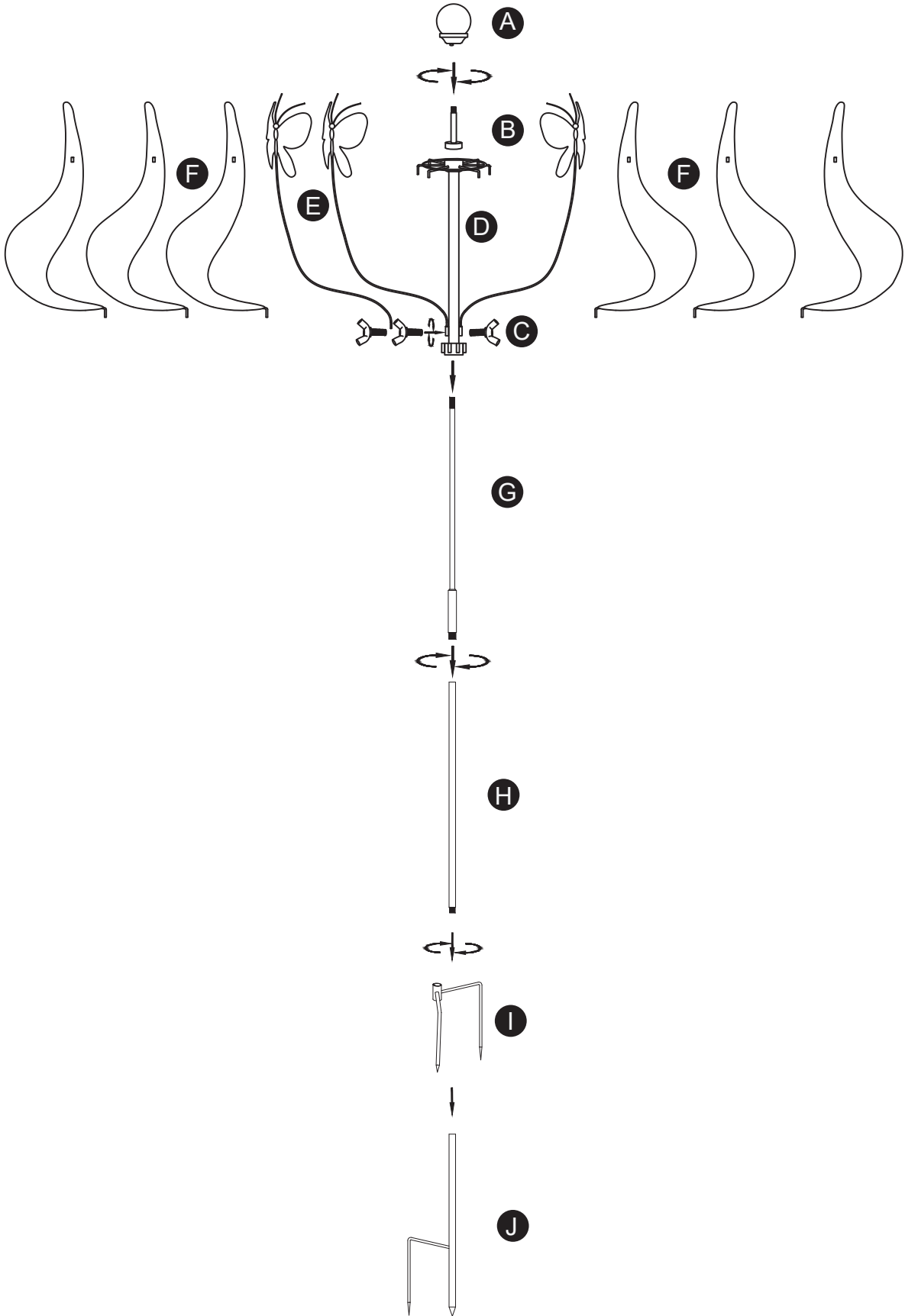

← **Questions?**
Scan Here

Product Parts

A



1PC

B



1PC

C



3 PCS

D

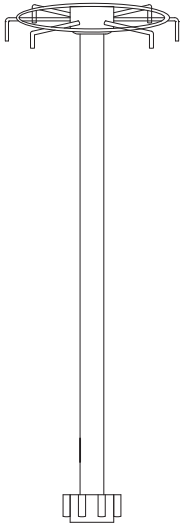

1PC

E

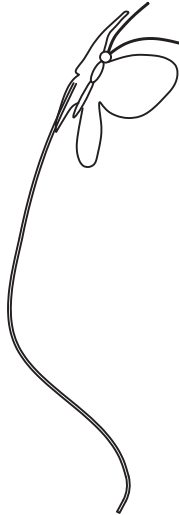

3 PCS

F

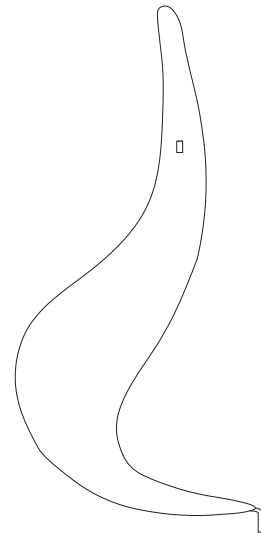

6 PCS

G



1PC

H



1PC

I

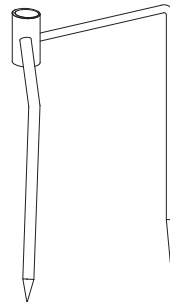

1PC

J



1PC

! Care Instructions

Dust surface with a dry soft cloth.

Do not use window cleaners or cleaning abrasives as they will scratch the surface and could damage the protective coating

! WARNING

Small parts and sharp edges may be present prior to assembly.



Questions?
Scan Here

Step 1

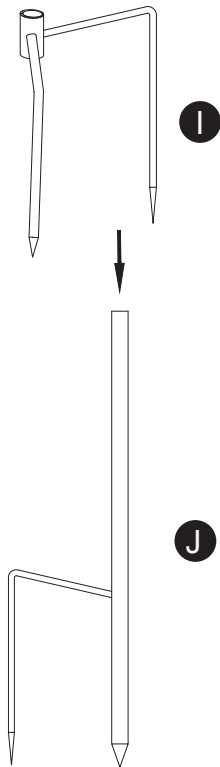

Step 2

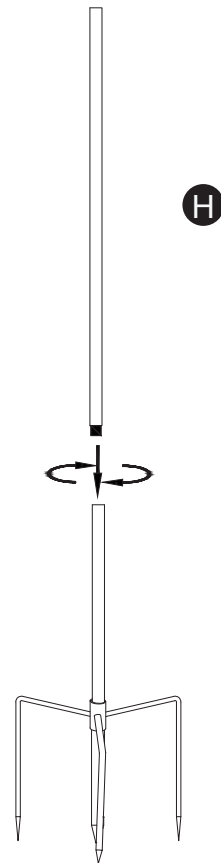

Step 3

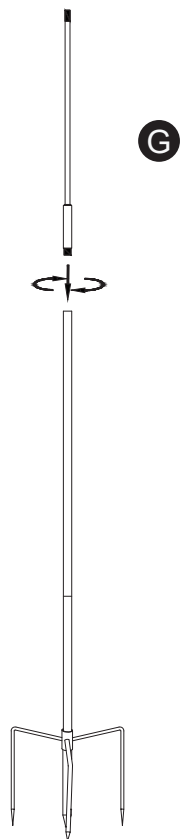

Step 4

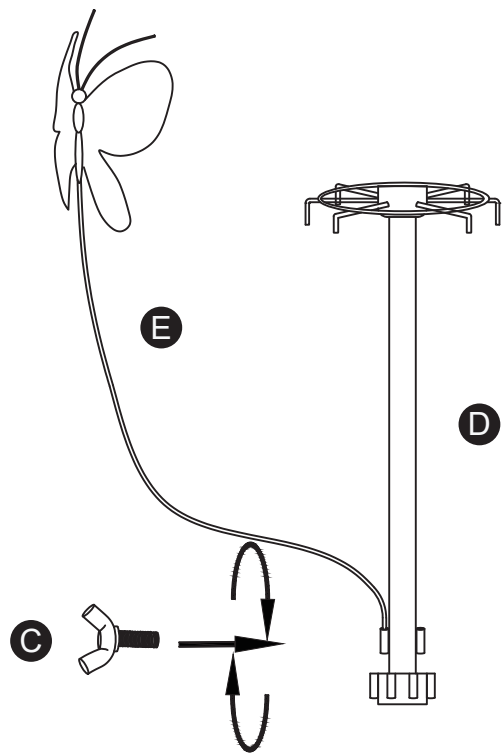

← **Questions?**
Scan Here

Step 5

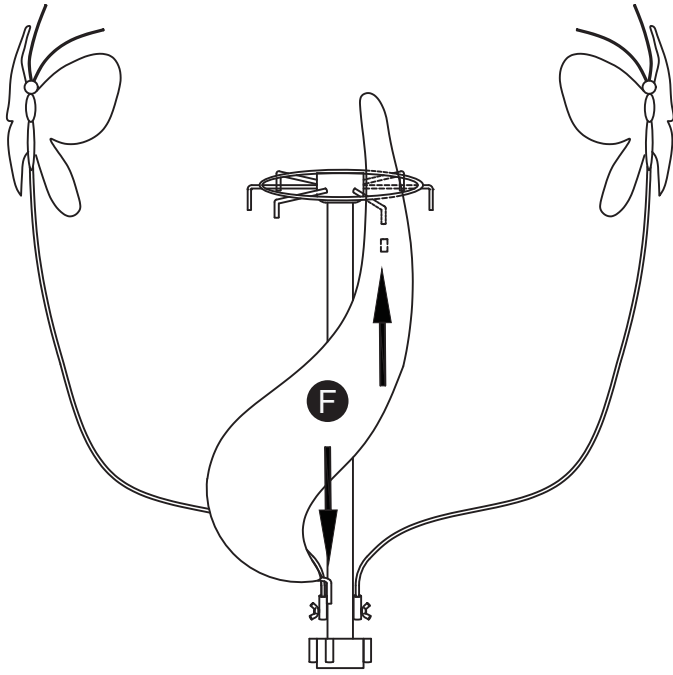

Step 6

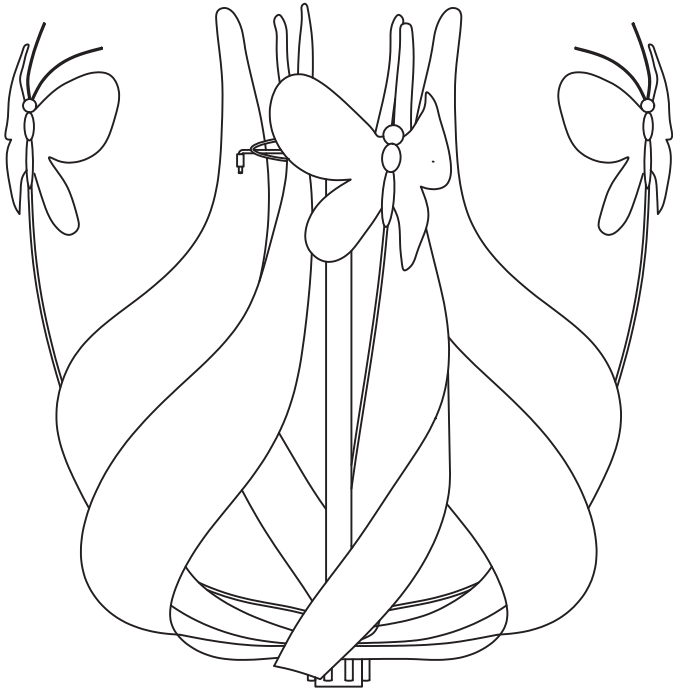

Step 7

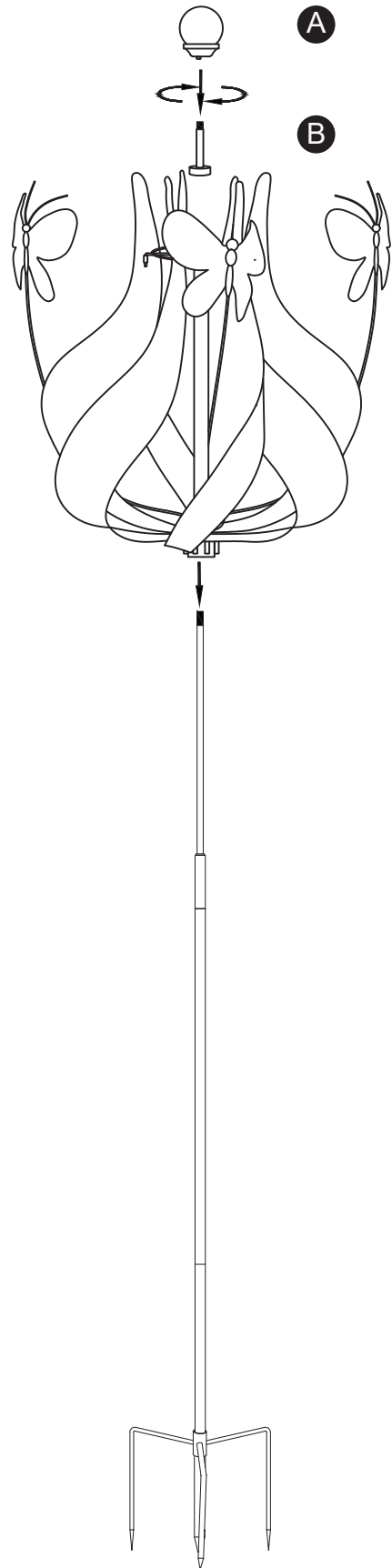

← **Questions?**
Scan Here