

PLEASE CONTACT US FIRST

TollFree: 1-800-935-3959 (Mon. Fri. 9:00AM to 5:00 PM EST)

✉ support@teamson.com

☎ 1-631-274-3353

Thank you for choosing Teamson produce. If you need help with assembly or if you are missing parts, hardware, we are here to help !

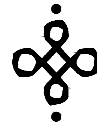

Versanora

Item No: VNF-00080

Item name: Versanora -Ashton Round DiningTable- Faux Marble/Walnut

#### Warning

Small parts and sharp points may be present prior to assembly.





Please follow the assembly instructions closely. Improper assembly can result in personal or property damage. 2 adults are required to safely assemble this product.

#### Care Instructions

Dust often using a clean, soft, dry and lint-free cloth. • When blot spills, wipe with a clean, damp cloth immediately. We do not recommend the use of chemical cleansers, abrasives or furniture polish on our lacquered finish.



Periodically check to make sure all connections are tight. Re-tighten if necessary.

#### Hardware List:

A		8PCS
B		8PCS
C		8PCS
D		1PCS



#### Part List:





1	2
	
1PC	4PCS

MADE IN CHINA

www.teamson.com

STEP 1

Anti -Tip hardware assemble

A:		8 PCS
B:		8 PCS
C:		8 PCS
D:		1 PCS

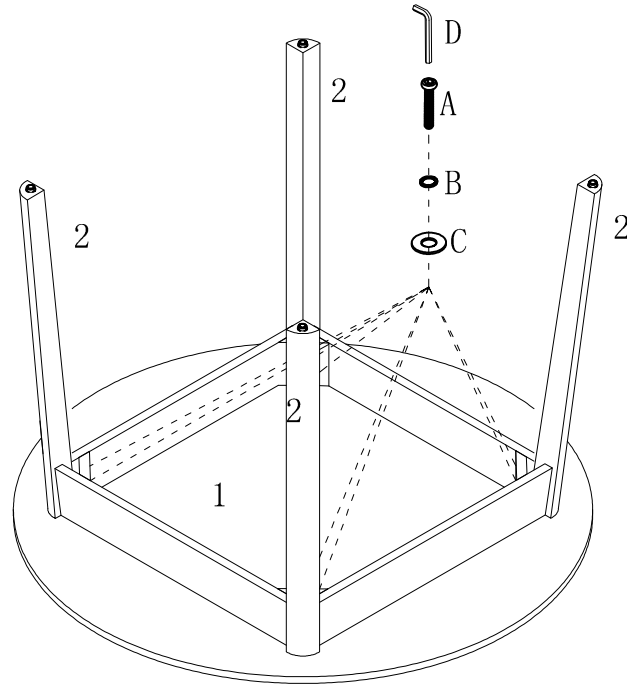

STEP 2



MADE IN CHINA

[www.teamson.com](http://www.teamson.com)