







ASSEMBLY INSTRUCTION

ITEM# 3016-90866 6/0-6/6 Tufted Headboard-Bling (A)
 3016-90968 6/6 Bling Footboard (B) & Rails(C)

**Caution: Please make sure you have all parts indicated below prior to assembly.
 This unit is heavy and can best be assembled with the help of two or more persons.**

NO.	HARDWARE LIST		Q'TY
F		FULL TREADED BOLT	8
G		CURVED WASHER	8
H		NUT	8
I		SPANNER WRENCH	1
J		SCREW	16
L		4MM ALLEN WRENCH	1
P		5MM ALLEN WRENCH	1

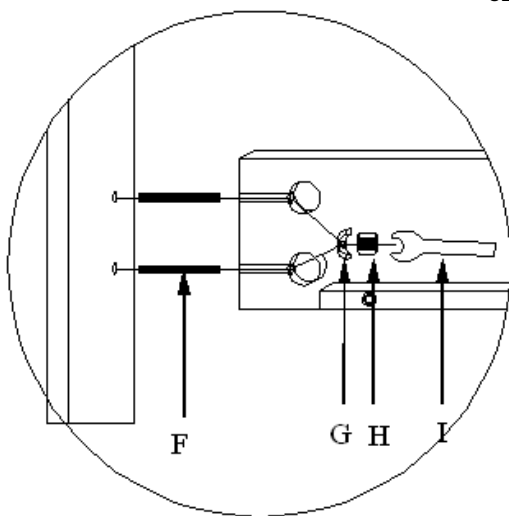
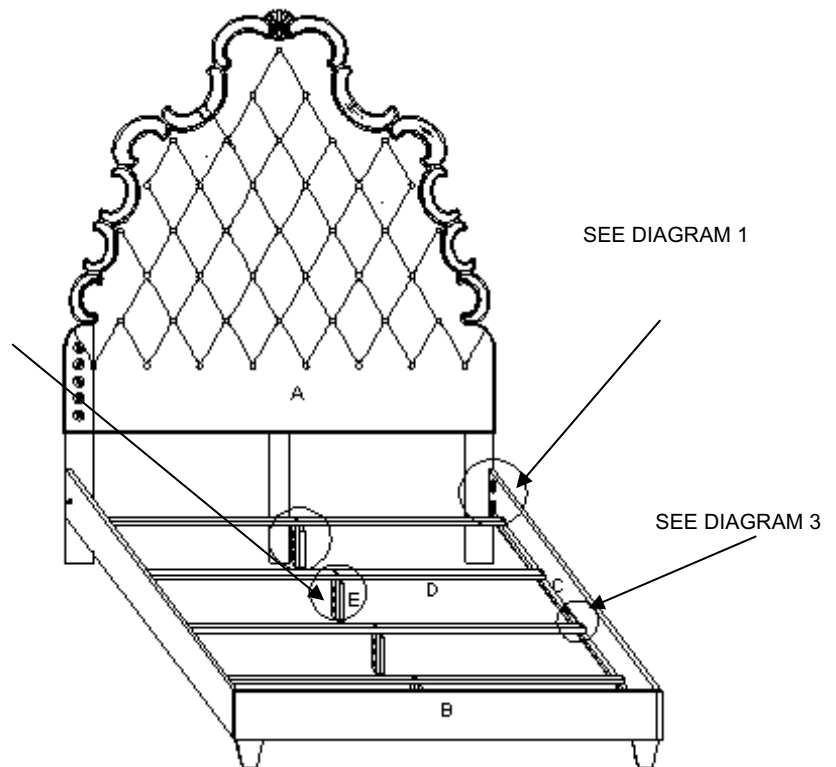

Diagram 1

SEE DIAGRAM 2



Assembly steps:

1. Insert 2 bolts (F) into holes of each post on Headboard (A) and Footboard (B), attach the end of side rails (C) to the bolts (F) on posts using 2 curved washers (G) and 2 nuts (H), tighten nuts (H) securely with spanner wrench (I). (See diagram 1)

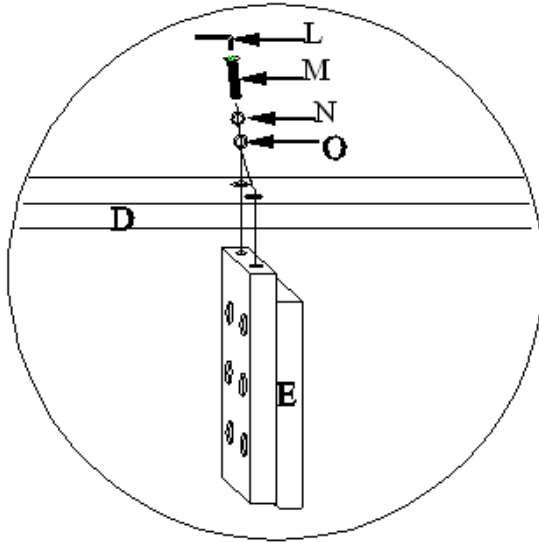

Diagram 2

2. Take out center supports (E) from rail box, place center supports (E) under slats (D) by using 2 bolts (M), 2 lock washers (N) and 2 flat washers (O). Secure the bolts (M) by using allen wrench (L) in clockwise direction. (See diagram 2)

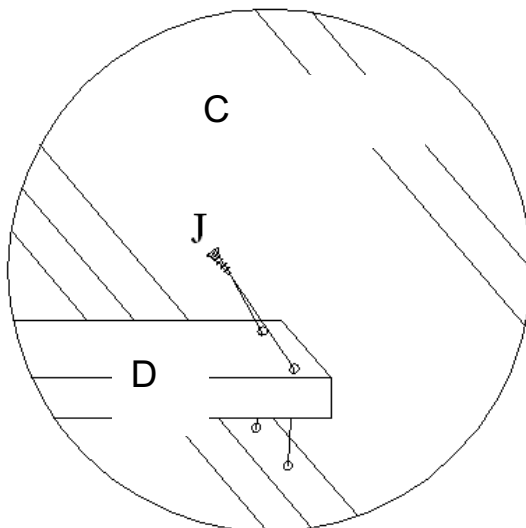

Diagram 3

3. Attach slats (D) to side rails (C), align pre-drilled holes on the slat to holes on the cleat of side rail (C), using screws (J) to tighten both. (See diagram 3)

Note: You can change the height of slat by adjusting the height of cleat on side rail as shown in diagram 4

1. remove the bolt (Q), lock washer (R) and flat washer (S) from the cleat by turning the bolt (Q) with allen wrench (P) in anti-clockwise direction, adjust the cleat to a desired position, and then secure the lock washer, flat washer, bolt in a clockwise direction by turning with allen wrench(P).

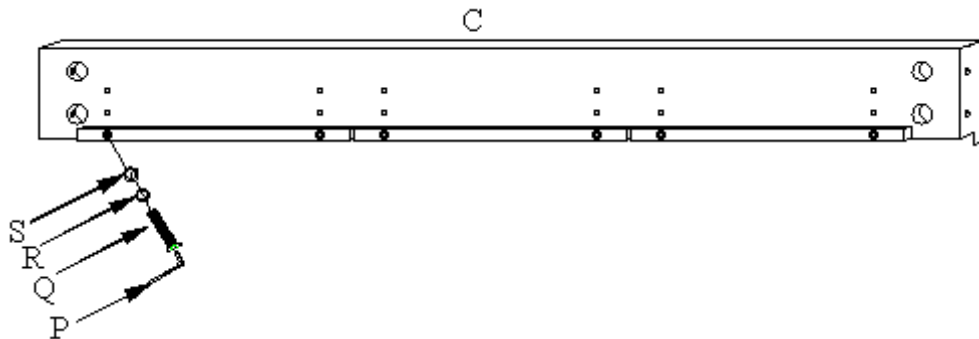

Diagram 4

You can adjust the height of center supports (L) as shown in Diagram 5 to meet your need by following steps.

1. Unscrew bolts on center supports (E) with allen wrench (L).
2. Adjust the height of center supports, align the holes on 2pcs of woods and tighten them together with 2 bolts(M), 2 lock washers (N) and two flat washers (O) by turning with allen wrench(L) in a clockwise direction.

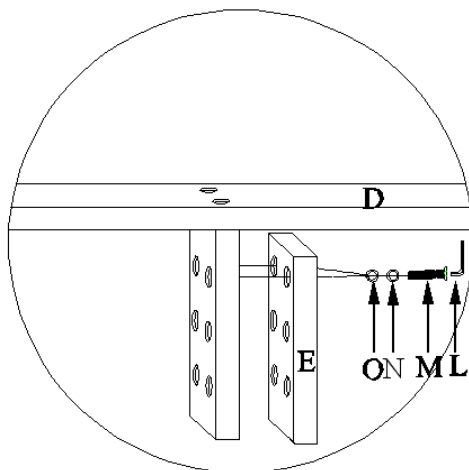

Diagram 5

Cleaning Instruction: Clean finished parts with a mild dishwashing liquid and water solution on a damp cloth.
Polish the finish with soft cloth and an industry recognized furniture polish.