

Entertainment Console

IMPORTANT

Carefully remove all the parts from the carton and place them individually on a soft cloth to prevent scratches or other damage.

Carefully and strictly follow these assembly instructions to ensure a completed product as designed.

Do not use power tools above 8 volts to assemble.

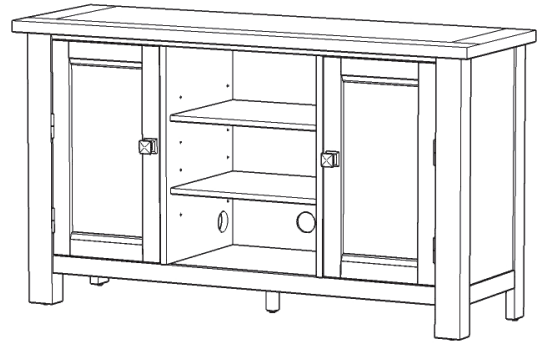

Part List



B.
Side Panel
1 pc.

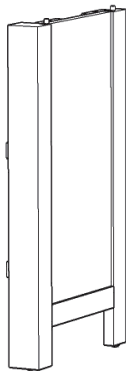

C.
Side Panel
1 pc.



D.
Middle Panel
1 pc.



E.
Middle Panel
1 pc.

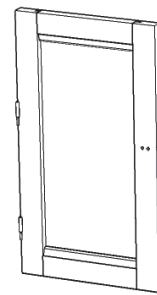

N.
Door
1 pc.

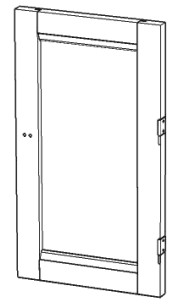

O.
Door
1 pc.

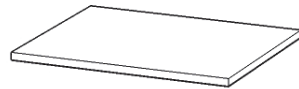

M.
Shelf
2 pcs.



P.
Support
1 pc.

Hardware List

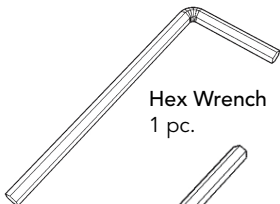

Hex Wrench
1 pc.

Small Hex Wrench
1 pc.

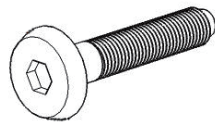

M6x35
Head Cap Bolt
8 pcs. (+1 extra)



Spring Washer
8 pcs. (+1 extra)



Flat Washer
8 pcs. (+1 extra)

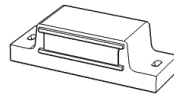

Magnet
2 pcs.



M3x16
Wood Screw
4 pcs. (+1 extra)

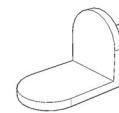

Adjustable Pin
24 pcs. (+1 extra)

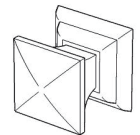

Knob
2 pcs.



M4x25
Machine Screw
4 pcs.

Carton 88 5412 101 is also needed for assembly.

Tool(s) required for assembly: Phillips screwdriver, Level, Drill (8 volts or less), 3/8" Drill Bit

Home Styles Customer Service: www.homestyles-furniture.com,
 servicedesk@homestyles-furniture.com, 888-680-7460, 877-831-0319

Assembly Instructions 2/4

IMPORTANT

- Use a soft cloth between these parts and the floor.
- Do not use power tools above 8 volts to assemble.
- Do not tighten all the bolts until each part is properly assembled.
- The unit must be level to work properly. Use the included adjustable levelers to level.
- Keep Hex Wrench in a safe place as the bolts may need to be tightened up in the future.

STEP 1

Attach Side Panels (B) and (C) to Base (F) with Flat Washers, Spring Washers and Head Cap Bolts. (See Figure 1)

Attach Middle Panels (D) and (E) to unit, then flip the locks. (See Figures 2 and 3)

Attach Support (P) to unit.

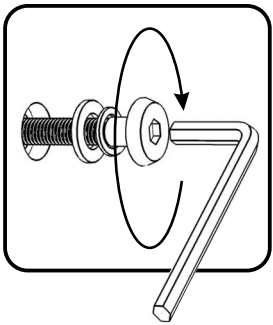
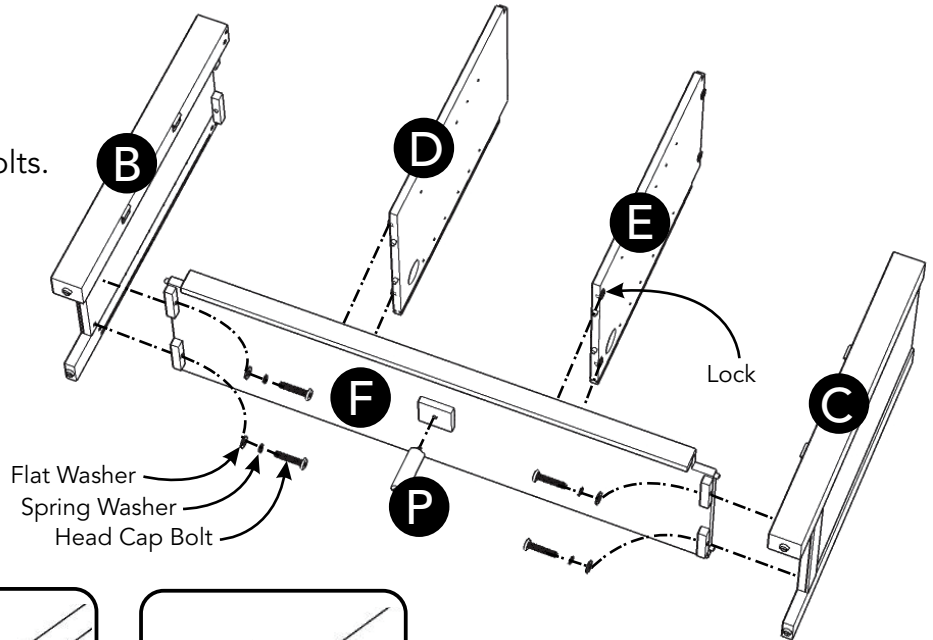

Figure 1

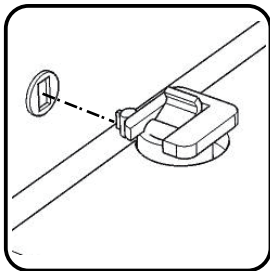

Figure 2

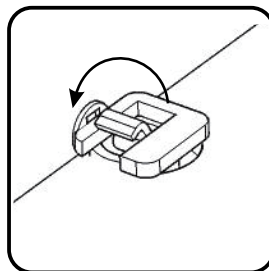

Figure 3

STEP 2

Turn unit to its' upright position.

Slide Back Panels (I) and (J) into position.

Attach Magnets to Front Stretcher (G) with Wood Screws. (See Figure 4)

Attach Front Stretcher (G) and Back Stretcher (H) to unit, then flip the locks.

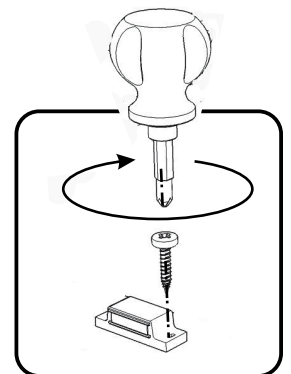
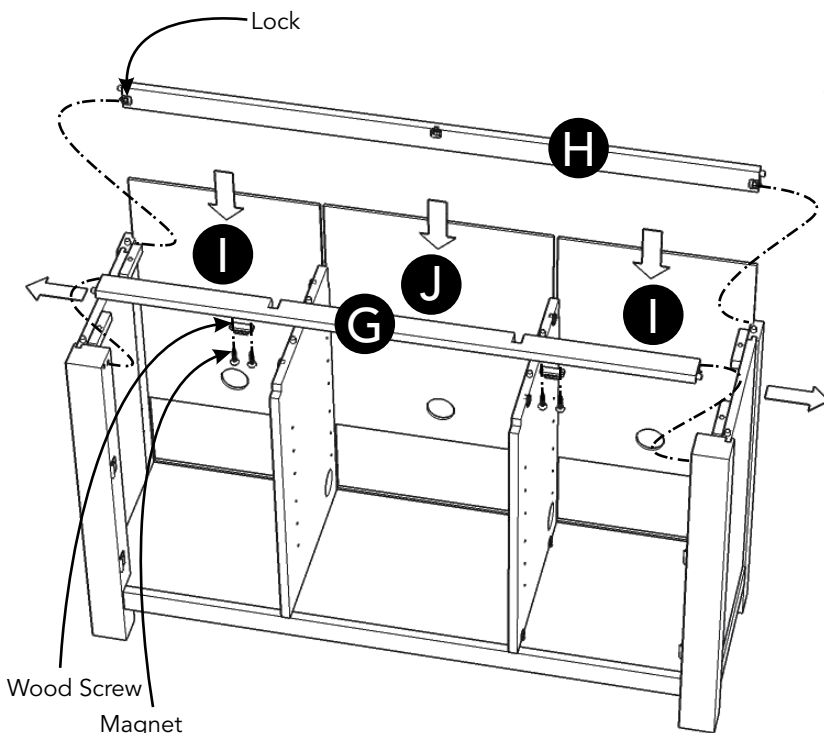

Figure 4

Assembly Instructions 3/4

STEP 3

Attach Top (A) to unit with Flat Washers, Spring Washers and Head Cap Bolts, then flip the locks.

Level unit by adjusting the adjustable levelers on the bottom of legs. (See Figure 5)

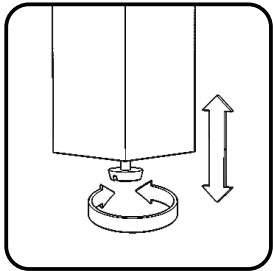

Figure 5

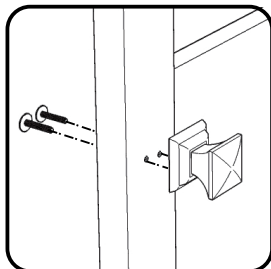
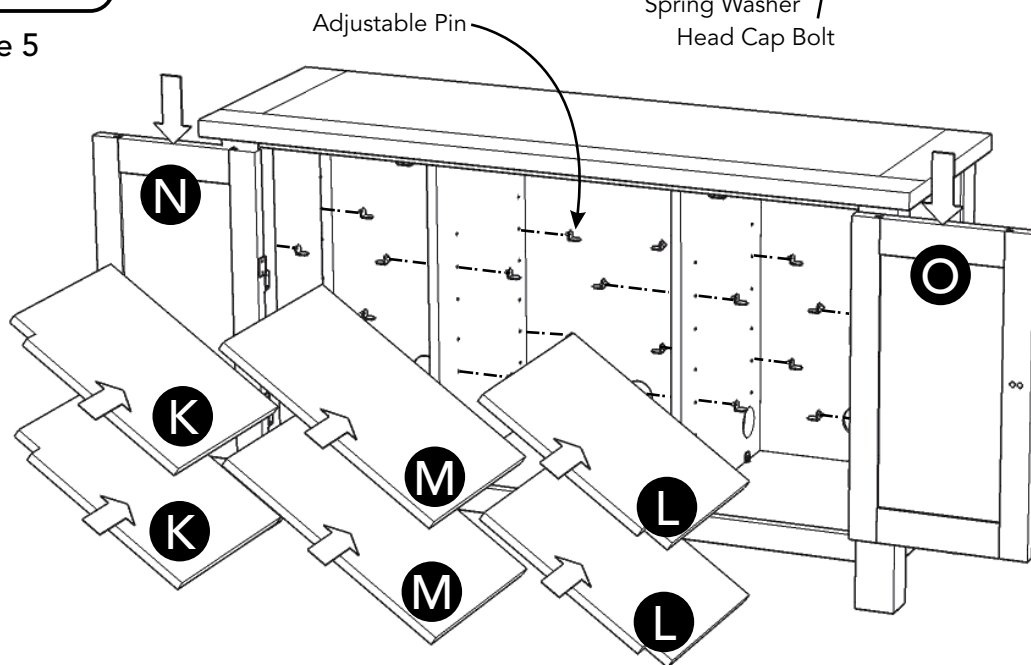
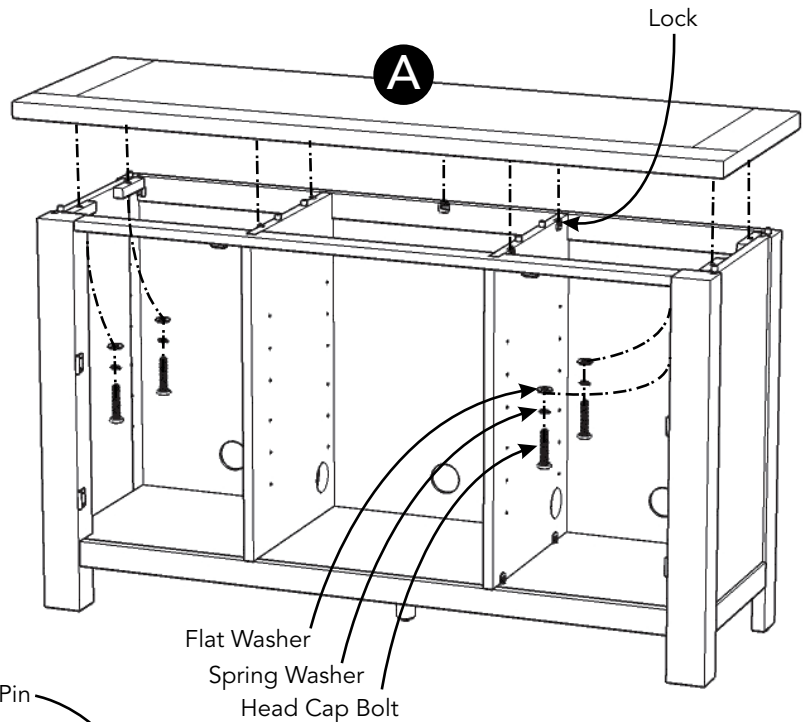

Figure 6

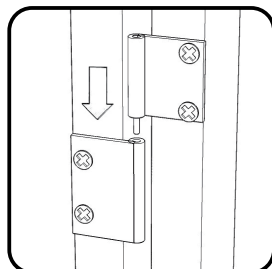

Figure 7

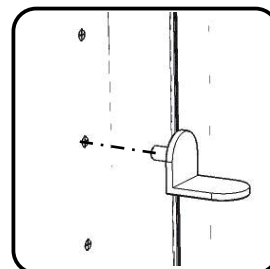

Figure 8

STEP 4

Attach Knobs to Doors (N) and (O) with Machine Screws. (See Figure 6)

Attach Doors (N) and (O) to unit by sliding the door lift hinges into the side panel left hinges. (See Figure 7)

Insert Adjustable Pins into side panels and middle panels at the desired level. (See Figure 8)

Place Shelves (K), (L) and (M) into position.

Assembly Instructions 4/4

IMPORTANT

- To help reduce the risk of the unit tipping over, the Tipover Restraint must be installed following these instructions exactly.

STEP 5

Place unit at desired location.

Drill a 3/8" hole in wall in-line with the pre-drilled hole at top of unit.

Move unit.

Insert Anchor into the wall hole and attach Bracket with Wall Screw.

Attach Bracket at pre-drilled hole at top of unit with Wood Screw.

Move unit back into place.

Slide Tipover Restraint through Bracket on wall and Bracket on unit.
(See Figure 9)

Put tie end of Tipover Restraint into lock end of Tipover Restraint and pull until tight.

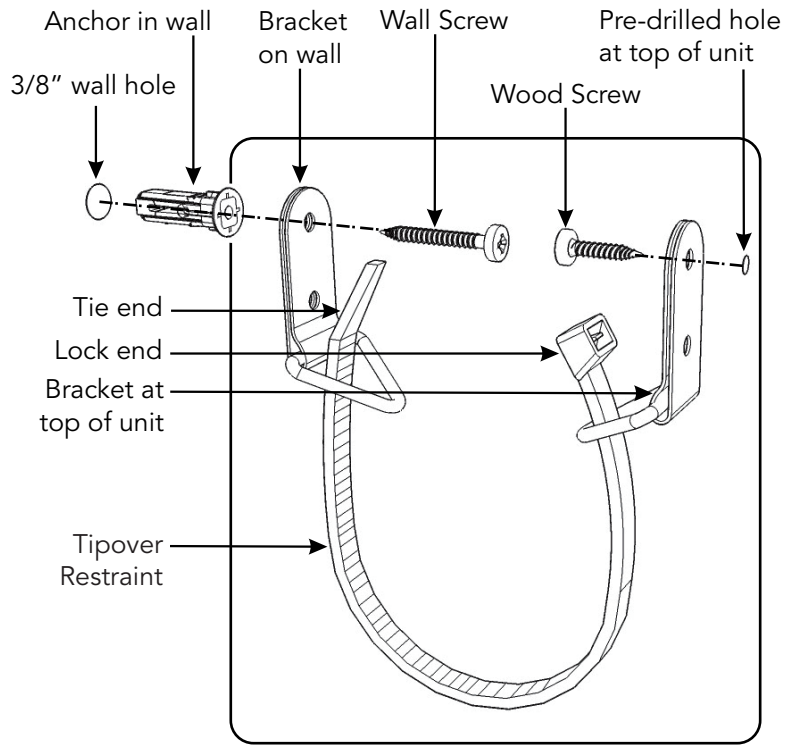
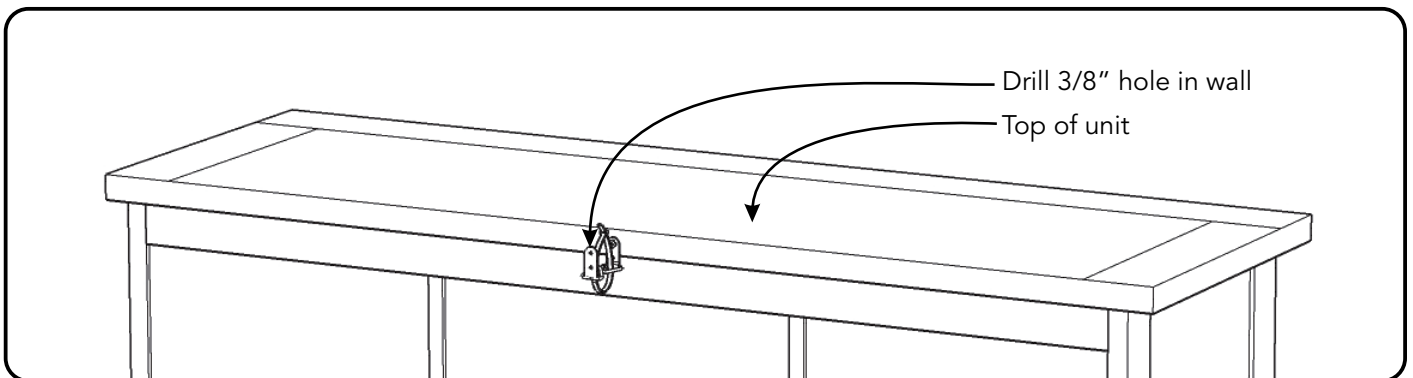
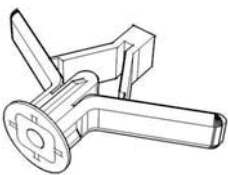

Figure 9



Hardware List



Anchor
1 pc. (+1 extra)

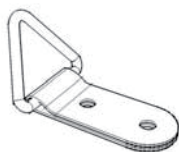

Bracket
2 pcs. (+1 extra)



Tipover Restraint
1 pc. (+1 extra)

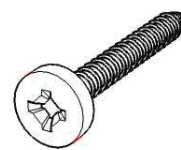

M3.5x40
Wall Screw
1 pc. (+1 extra)



M3.5x16
Wood Screw
1 pc. (+1 extra)

CARE INSTRUCTIONS

NEVER

allow liquids to remain on furniture.
Absorption causes parts to warp
and split and finishes to delaminate.

NEVER

use glass cleaners on
finished furniture. Ammonia
chemically attacks the finish.



Do not use power tools
above 8 volts to assemble.
**PREVENT
CRACKING**



Do not place
in direct sunlight.
**PREVENT
FADING**



Do not write
directly on surface.
**PREVENT
MARKING**



Do not place hot
objects on surface.
**PREVENT
FINISH DAMAGE**

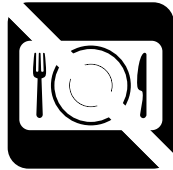

Do not use rubber
based placemats.
**PREVENT
DISCOLORING**



Do not use commercial
waxes and polishes.
**PREVENT
YELLOWING**

CLEAN

with a soft cloth moistened
in lukewarm soap and water.
Buff with a dry clean cloth.



Home Styles will provide replacements free of charge for missing or damaged hardware or parts within 30 days of purchase. Digital images of the defective parts may be required. If the product was not purchased from an authorized retail affiliate, Home Styles is under no obligation to provide replacement parts. Parts are not available for fully assembled items nor are parts available for sale. Replacements for missing or damaged hardware or parts may be requested at:

www.homestyles-furniture.com/customer-service/replacement-parts

Home Styles Customer Service: www.homestyles-furniture.com,
servicedesk@homestyles-furniture.com, 888-680-7460, 877-831-0319