



STEAM BATH GENERATOR USER GUIDE

BLACK SERIES

MODELS

4.5KW

6KW

7.5KW

9KW

10.5KW

12KW

15KW-24KW

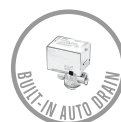

DON'T WAIT! REGISTER NOW!

Register your product within 90 days to ensure your steam bath generator is recognized as an official purchase and is eligible for warranty coverage.

Register online at <https://www.SteamSpa.com/register/> or scan the QR code on Page 2.



PRODUCT REGISTRATION*

IMPORTANT: Warranty will not be recognized unless product is registered.

Register online at www.SteamSpa.com/register or Scan the QR code below.

Registering your product maximizes your warranty benefits and ensures prompt service and support.

1

USE YOUR PHONE CAMERA
TO SCAN THE QR CODE



2

FILL IN A QUICK
REGISTRATION FORM

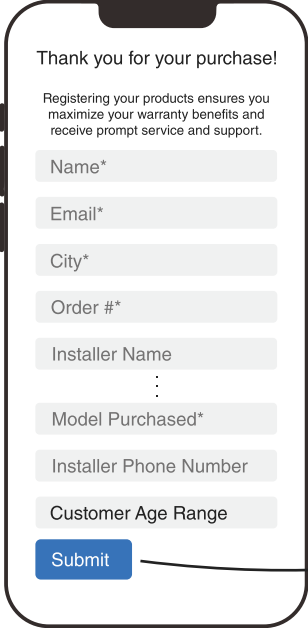

3

CLICK SUBMIT AND
ENJOY PEACE OF MIND

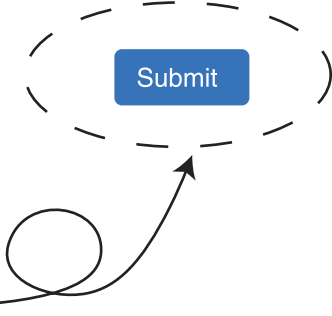

IMPORTANT WARRANTY INFORMATION!



The installation of a quick connect and release system is essential to the care and maintenance of your steam bath generator unit. Additionally, the use of an inline water filter with fresh cartridges prevents mineral deposit and built up from damaging the generator's internal plumbing and components.

Please be advised failure to comply with any of the following will VOID the warranty.

1. The User must register product within 90 days of delivery. See www.SteamSpa.com/register.
2. Installation must be performed by a licensed professional.
3. A quick release & pressure reducing valve must be used for reliable periodic maintenance.
4. An inline water filter must be installed to prevent mineral deposit and build up.
5. Filter cartridge must be replaced no later than every 6 months.

Malfunctions, damages, parts replacement and labor resulting from improper installation, negligence, or lack of care and maintenance will NOT be covered under the SteamSpa Warranty.

For more information visit www.SteamSpa.com/warranty or call 1-800-856-0172.

STEAM QUICK RELEASE & PRESSURE REDUCTION KIT w/ WATER FILTER PLUS EXTRA CARTRIDGES STMKIT-02



READ ME FIRST!

IMPORTANT NOTE: As you follow these instructions, you will notice warning and caution symbols. This blocked information is important for the safe and efficient installation, operation and maintenance of this generator. These are types of potential hazards that may occur during this installation and operation:

 **WARNING** states a hazard may cause serious injury or death if precautions are not followed.

 **CAUTION** signals a situation where minor injury or product damage may occur if you do not follow instructions.

IMPORTANT NOTE: This highlights information that is especially relevant to a problem-free installation.

IMPORTANT SAFETY INSTRUCTIONS

WARNING

1. Electrical grounding is required on all SteamSpa Generators.
2. All electrical supplies should be disconnected when servicing generators.
3. To reduce the risk of explosions, do not interconnect the steam lines.
4. To reduce the risk of injury, children under the age of 16 should not use the steam bath.
5. To reduce the risk of injury:
 - A. The wet surfaces of steam enclosures may be slippery. Be careful entering or leaving.
 - B. The steam head is hot. Do not touch the steam head and avoid the steam close to the steam head.
 - C. Prolonged use of the steam system can raise excessively the internal human body temperature and impair the body's ability to regulate its internal temperature(hyperthermia). Limit your use of steam to 10-15 minutes until you are certain of your body's reaction.
 - D. Excessive temperatures have a high potential for causing fetal damage during the early months of pregnancy. Pregnancy or possibly pregnant women should consult a physician regarding correct exposure.
 - E. Obese persons and persons with a history of heart disease, low or high blood pressure, circulatory system problems, or diabetes should consult a physician before using a steam bath.
 - F. Persons using medication should consult a physician before using a steambath since some medication may induce drowsiness while other medications may affect heat rate, blood pressure and circulation.

CAUTION

1. All wiring must be installed by a licensed electrical contractor in accordance with local and national codes.
2. All plumbing must be installed by a licensed plumber in accordance with all applicable local and national codes.
3. Series generators are for indoor use only. Protect from freezing.
4. Series generators are not for space heating purposes.
5. Electric Shock Hazard - High voltage exists within this equipment.

IMPORTANT SAFETY INSTRUCTIONS

6. Be certain that steam bath enclosures are properly sealed to avoid water damage from escaping steam. It's recommended that 100% silicone caulk be used to seal all pipes and fittings. Steam must be prevented from escaping into the wall cavity.
7. Never shut off the water to a steam generator that is in use.
8. We recommend choosing steamers which are closely matched in power. The highest kW steamer should be the primary unit. Each steamer should have its own automatic drain.
9. An exhaust fan installed outside the steam room is strongly recommended removing excess steam from the bathroom or shower area.
10. For commercial use, we recommend checking with your local inspectors to confirm the system is acceptable for your use. Many jurisdictions will require an ASME boiler for commercial use: Steam Spa generators are not boilers.
11. The steam outlet carries hot vapor! A separate steam line is required for each steam outlet. Do not connect a valve or shut-off in the steam line! Avoid traps and valleys in the steam line where water could collect and cause a steam blockage. The hot steam line must be insulated against user contact.
12. Do not install the steam head near a bench or where steam may spray or where condensation will drip on the user as this will present a scald hazard.
13. Centering the steam pipe is critical in rooms made of plastic, acrylic, resin, fiberglass or similar materials. Allowing the steam pipe to touch materials not rated 240°F (115°C) or higher will result in damage to these materials.
14. Wire the controls exactly as described. Do not connect any additional wiring or power supplies to the controls or their terminals in the generator.
15. SAVE THIS MANUAL.

HYPERTHERMIA

The causes, symptoms, and effects of hyperthermia may be described as follows: Hyperthermia occurs when the internal temperature of the body reaches a level several degrees above the normal body temperature of 98.6° F. The symptoms of hyperthermia include an increase in the internal temperature of the body, dizziness, lethargy, drowsiness, and fainting.

The effects of hyperthermia include:

- a) Failure to perceive heat
- b) Failure to recognize the need to exit the steambath
- c) Unawareness of impending risk
- d) Fetal damage in pregnant women
- e) Physical inability to exit the steambath
- f) Unconsciousness.

 **WARNING** The use of alcohol, drugs, or medication can greatly increase the risk of hyperthermia.

This peel-n-stick warning label must be applied to the wall of the shower or steam enclosure, at a point visible to all users. Failure to install sticker may result in serious injury or death. For replacement label contact SteamSpa at 1-800-856-0172 or info@steamspa.com.

 **WARNING**

REDUCE THE RISK OF OVERHEATING AND SCALDING

1. EXIT IMMEDIATELY IF UNCOMFORTABLE, DIZZY OR SLEEPY. STAYING TOO LONG IN A HEATED AREA IS CAPABLE OF CAUSING OVERHEATING.
2. CHILDREN UNDER THE AGE OF 16 SHOULD NOT USE THE STEAM BATH.
3. CHECK WITH A DOCTOR BEFORE USE IF PREGNANT, DIABETIC, IN POOR HEALTH OR UNDER MEDICAL CARE.
4. BREATHING HEATED AIR IN CONJUNCTION WITH CONSUMPTION OF ALCOHOL, DRUGS, OR MEDICATION IS CAPABLE OF CAUSING UNCONSCIOUSNESS.
5. DO NOT CONTACT STEAM HEAD OR STEAM AT THE STEAM HEAD.

REDUCE THE RISK OF SLIPPING AND FALL INJURY

1. USE CARE WHEN ENTERING OR EXITING THE STEAM ROOM. FLOOR MAY BE SLIPPERY.

NOTE: FOR ADDITIONAL SAFETY CONSIDERATIONS SEE OWNER'S MANUAL

TABLE OF CONTENTS

PROLOGUE	07
USER INSTRUCTIONS	07
CHOOSING THE RIGHT LOCATION	07
STEAM GENERATOR SPECIFICATIONS	08
ELECTRICAL REQUIREMENTS	09
INSTALLATION DRAWING OF STEAM GENERATOR.....	10
INSTALLATION DRAWING OF DUAL STEAM GENERATOR	12
PLUMBING INSTALLATION.....	14
ASSEMBLY GRAPH FOR POWER WIRE	15
WIRING DIAGRAM.....	16
STEAM GENERATOR DISSECTION DIAGRAM	18
CARE & USE FOR THE CONTROL PANEL	19
CONTROL SYSTEM COMPONENTS	19
CONTROLLER SPECS.....	20
CONTROL PANEL INSTALLATION INSTRUCTIONS(GS08TA)	21
WIRELESS CONTROL PANEL INSTALLATION INSTRUCTIONS	22
INSTALLING LIGHT	23
INSTALLING SPEAKERS	23
TESTING MACHINE	24
CONTROL PANEL DESCRIPTION (GS08TA).....	24
OPERATION	25
OUTSIDE SECONDARY ON/OFF CONTROL	29
CONTROL PANEL DESCRIPTION (WTPFFMK).....	30
CONTROL PANEL DESCRIPTION (WTPMK)	32
APP MANUAL FOR STEAM GENERATOR	34
STEAM GENERATOR MAINTENANCE.....	42
TROUBLE SHOOTING GENERATOR	43
TROUBLE SHOOTING-GS08TA.....	44
TROUBLE SHOOTING-WTPFFMK/WTPMK	44
STEAM SPA TROUBLE SHOOTING	45
MAINTENANCE LOG	47
TECHNICAL PARAMETERS	49
WIRING CONNECTION (ONE STEAM GENERATOR WITH GS08TA).....	49
WIRING CONNECTION (TWO STEAM GENERATOR WITH GS08TA)	50
WIRING CONNECTION (ONE STEAM GENERATOR WITH WTPFFMK).....	51
WIRING CONNECTION (TWO STEAM GENERATOR WITH WTPFFMK)	52
WIRING CONNECTION (ONE STEAM GENERATOR WITH WTPMK).....	53
WIRING CONNECTION (TWO STEAM GENERATOR WITH WTPMK)	53
SIZING CHART OF STEAM GENERATOR	54
SIZING CHART OF DUAL STEAM GENERATORS	55

IMPORTANT!

PRIOR TO INSTALLATION, LET WATER RUN THROUGH THE WATER PIPE TO CLEAN ANY POSSIBLE DEBRIS BEFORE CONNECTING THE GENERATOR.

PROLOGUE

Thank You for choosing SteamSpa for health, beauty and relaxation. Now you can enjoy your own private sanctuary in the comfort of your own home. Let your stress melt away as you relax in your state of the art Steam Room.

WARRANTY

SteamSpa warrants that this steam bath generator unit will be free from manufacturer defects and malfunctions. For terms and condition please refer to latest SteamSpa Warranty at www.SteamSpa.com/warranty.

Please be advised failure to comply with any of the following will VOID the warranty.

1. Generator and Use are registered within 90 days of delivery. See www.SteamSpa.com/register.
2. Installation must be performed by a licensed professional.
3. A quick release & pressure reducing valve must be used for reliable periodic maintenance.
4. An inline water filter must be installed to prevent mineral deposit and build up.

USER INSTRUCTIONS

1. Check for visible damages upon delivery of Generator. Any damages to packaging should be reported immediately to shipping company delivery representative and SteamSpa's Customer Service Dept.
2. Check model and accessories are correct, including voltage input. Any discrepancies are to be reported to SteamSpa's Customer Service Dept. within 48 hours of delivery.
3. Read installation instructions in detail for a secure and effective installation of SteamSpa generators.
4. SteamSpa shall not be responsible for product damage or malfunction caused by self-installation or installation procedures which do not comply with user manual.

CHOOSING THE RIGHT LOCATION

1. The generator should be less than 25ft from the steam room for best performance.
2. The steam generator should not be installed in the steam room.
3. Do not install outdoor or in any places that will influence the performance of the machine by the environment.
4. Do not install in a frigid location or any places where the water will be frozen.
5. Do not install near flammable chemicals.
6. Install in a dry place where the ventilation is good.
7. Install an exhaust fan outside of the steam room for the excess steam to be expelled from the shower room.
8. The steam generator has a hanging groove for wall installations.
9. Both sides and the top of the steam generator need to reserve at least 12 inches space.
10. The area where the machine is installed must be easily cleaned up and convenient for the disassembly of the machine.
11. The installation area must be convenient for the steam generator draining system.
12. The steam pipe, pressure relief valve, water drain valve, water tube and steam outlet remain very hot after the steam generator has stopped working for some time.
13. The control panel should be installed away from the steam head to avoid false readings.
14. Always install generator horizontally so that the water level sensor works normally.

STEAM GENERATOR SPECIFICATIONS

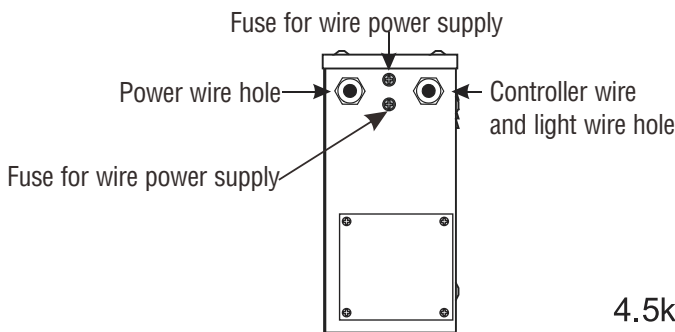
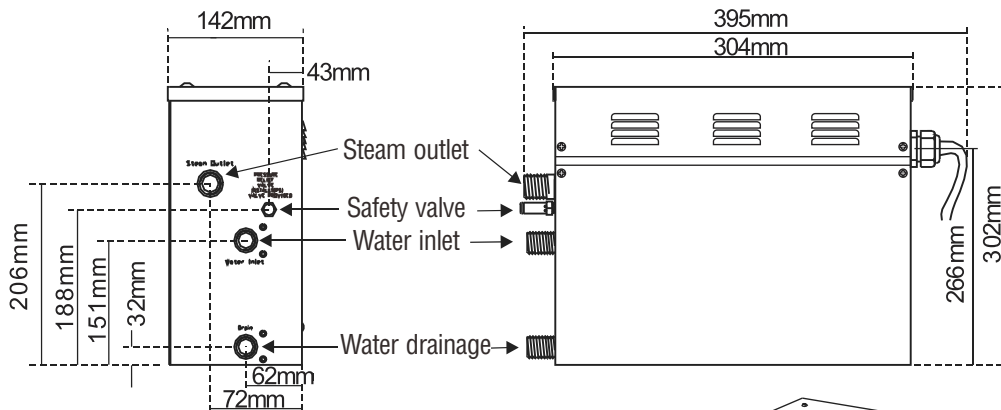

4.5kW

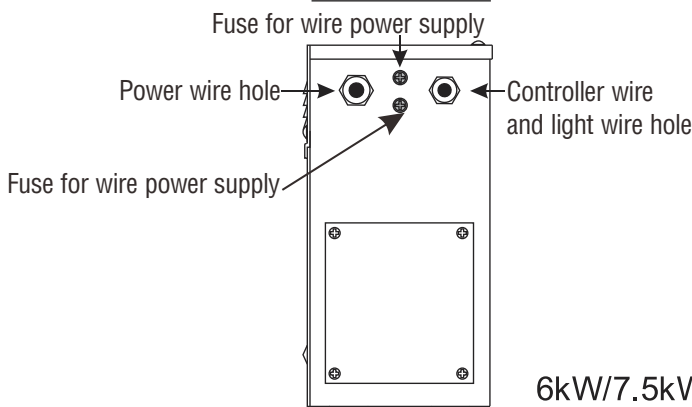
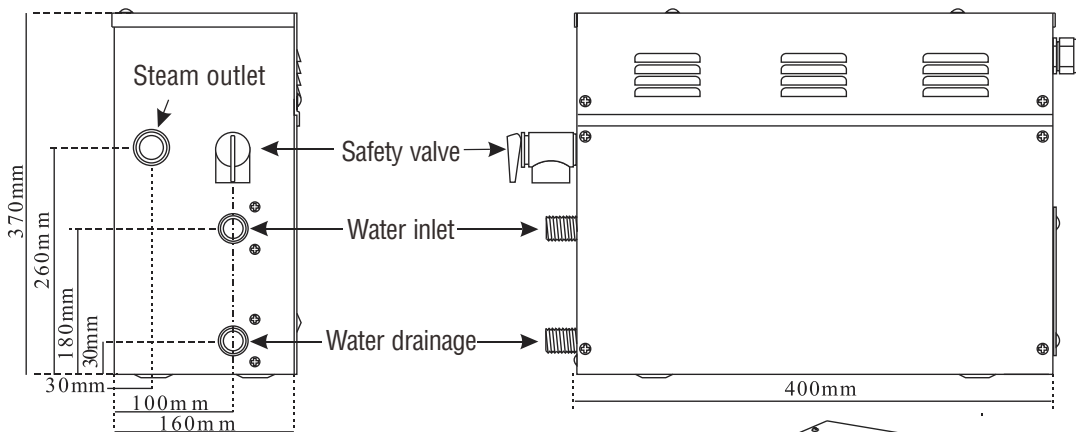
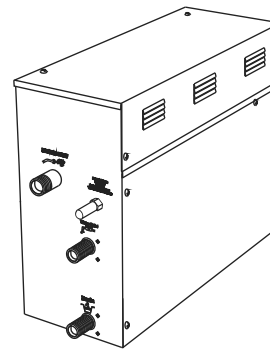

6kW/7.5kW/9kW

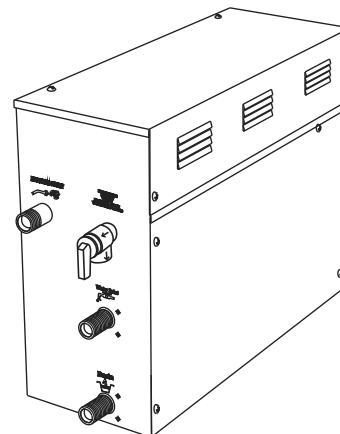

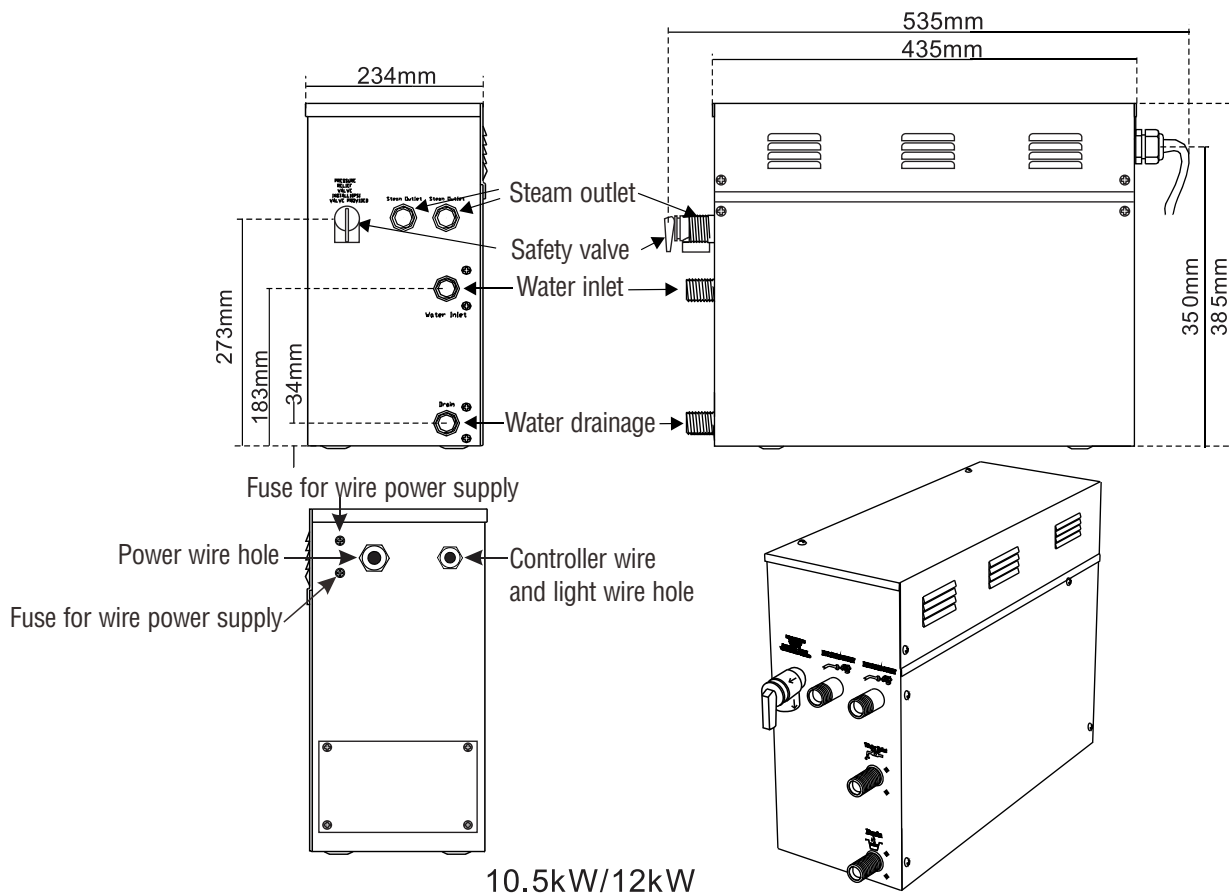

ATTENTION! To facilitate maintenance, keep the steam engine clean. If the information provided is limited, do not operate on the pipeline and electric equipment arbitrarily as shown in the figure for proportion.

ELECTRICAL REQUIREMENTS

ELECTRICAL SUPPLY CIRCUITRY

1. Test the voltage of the power supply and make sure suitable voltage is used for the steam generator.
2. Insulated copper wire should be used with an anti-heat temperature of 194°F(90°C) and a specified voltage of 300V. Refer to national or local electricity consumption code for the specifications. Refer to the Ampere Meter for the ampere.
3. Connect suitably sized equipment grounding wire into the ground terminal.
4. All the connections must be in accordance with national and local electricity consumption codes and be installed by professional electricians.

Ampere Meter

Type	Power KW	Electricity supply (1PH)	Electricity current(A)	Specifications for power wire (AWG)
B02-450	4.5	240V	19	12
B02-600	6	240V	25	10
B02-750	7.5	240V	32	8
B02-900	9	240V	38	8
B02-1050	10.5	240V	44	6
B02-1200	12	240V	50	6

The data provided above is for 240V single-phased models. Install an independent circuit breaker between supply line and steam generator. Install a power disconnect within sight of steam generator to cut-off power when not in use.

INSTALLATION DRAWING OF STEAM GENERATOR

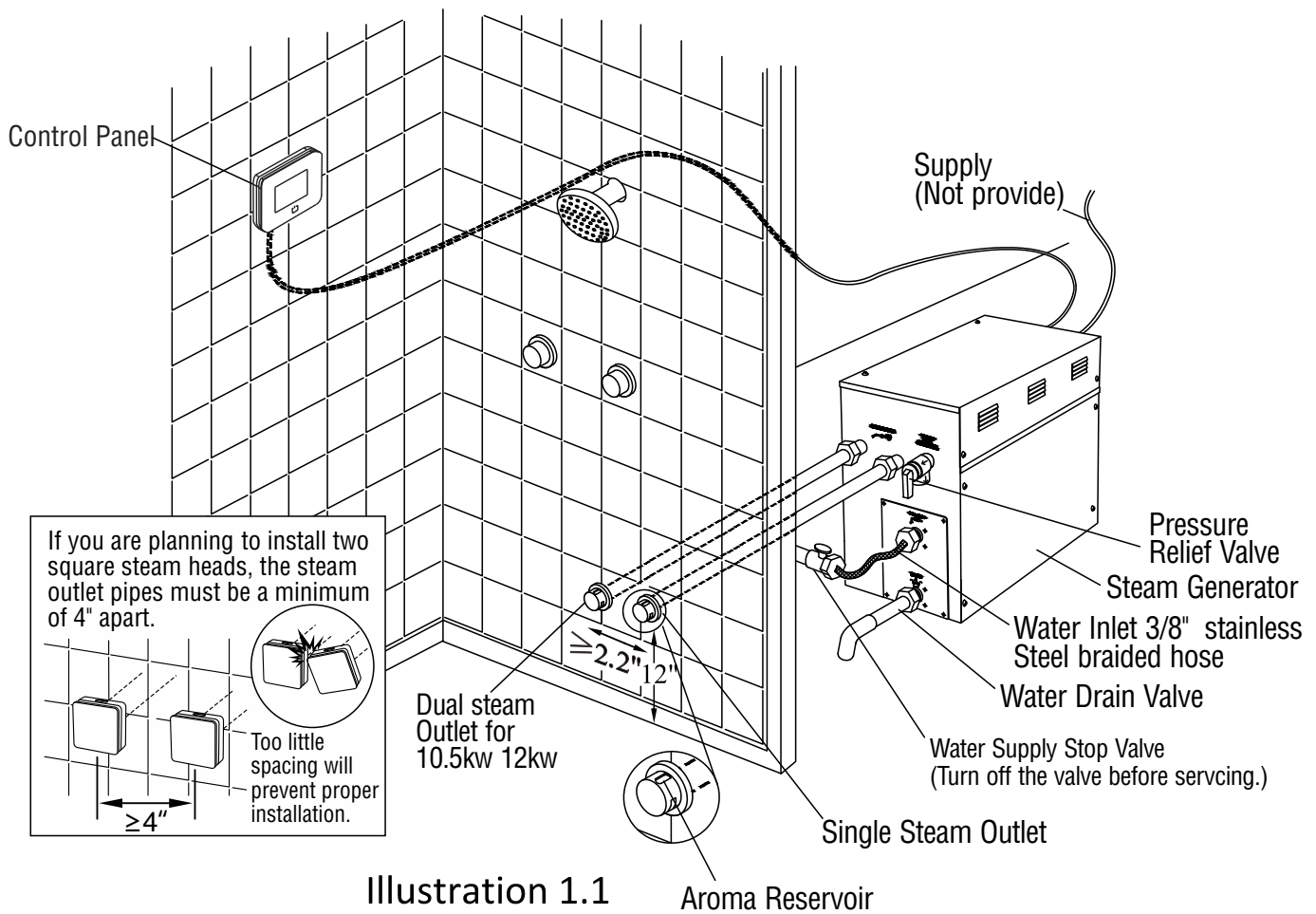

Illustration 1.1

INSTALLATION & USER GUIDE

ATTENTION! The drawing is only for explanation purposes. As for practical design of steam room, please consult a qualified designer, architect or builder.

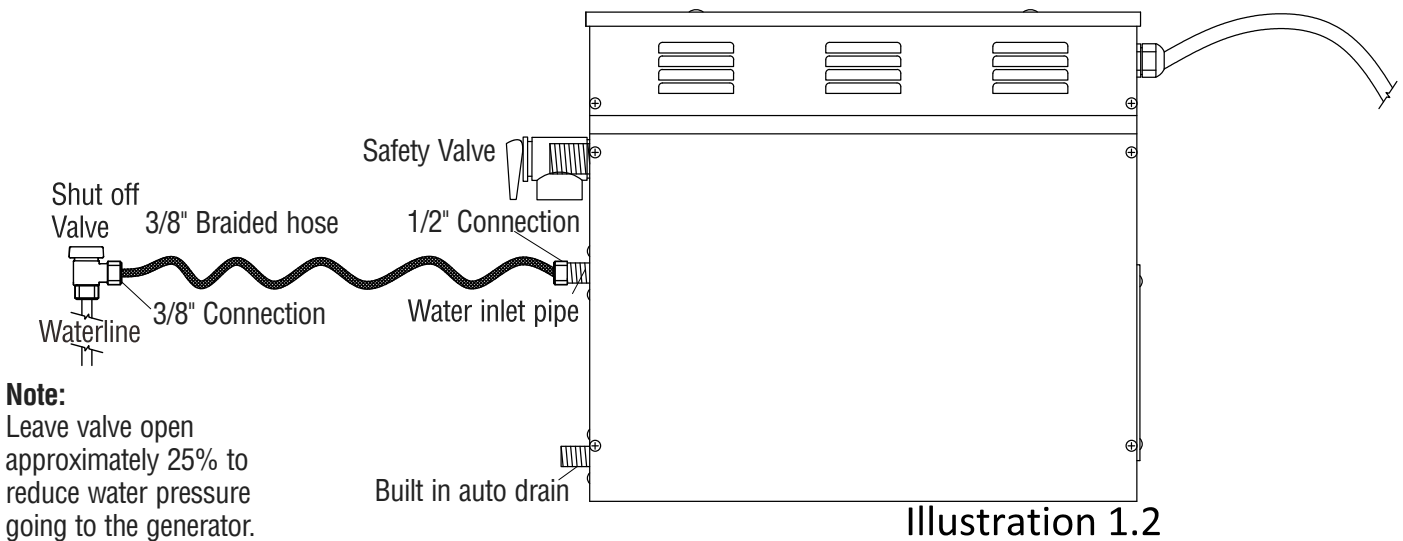

Illustration 1.2

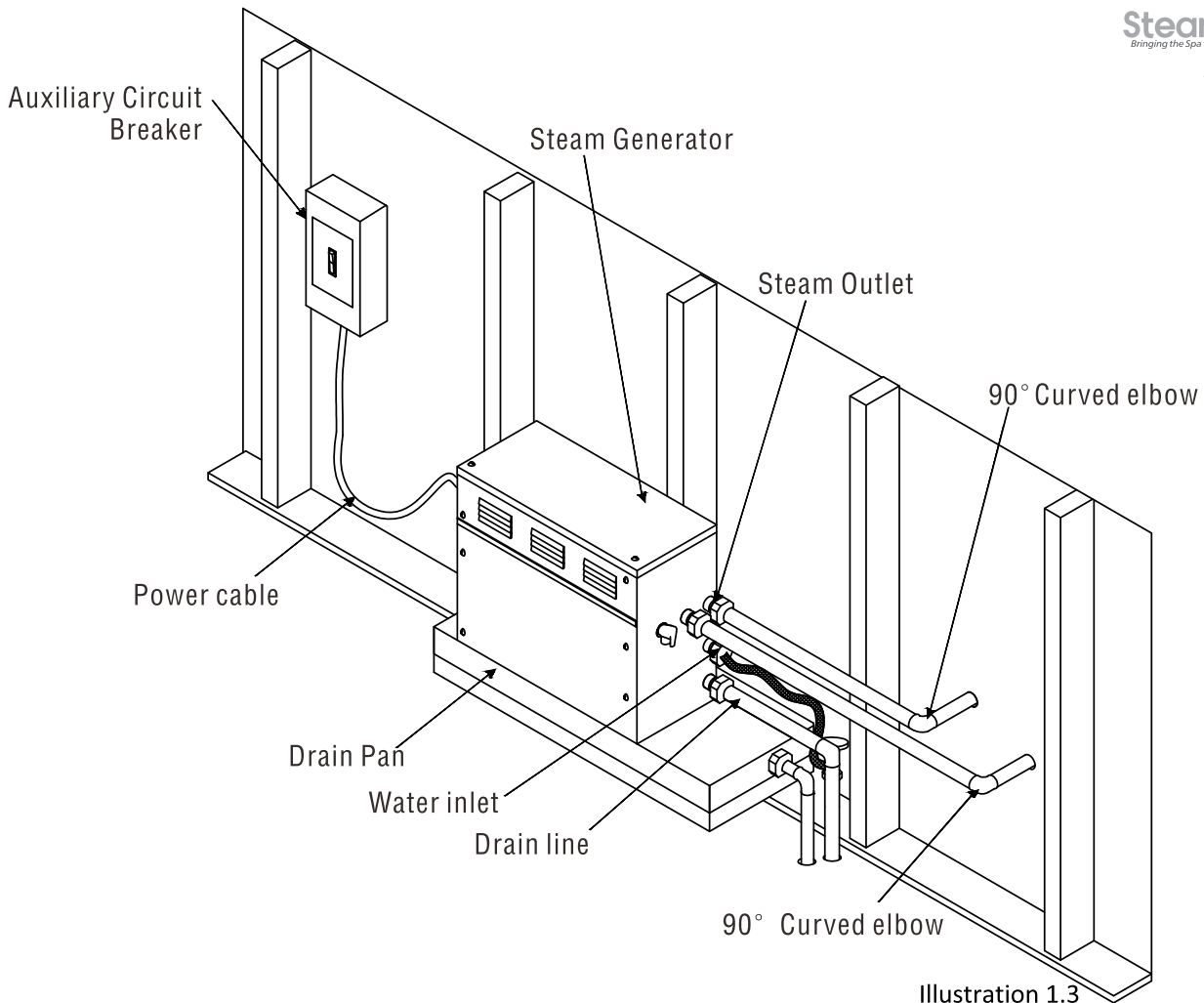

Illustration 1.3

ATTENTION! The drawing is only for explanation purposes, please consult a qualified designer, architect or builder.

IMPORTANT! All pipe connections should have unions and adapters for easy disconnect.

ATTENTION! Proper installation is a critical requirement per the SteamSpa Warranty terms and conditions. A licensed professional must be used to ensure proper installation. A quick release system, pressure reducing valve, inline water filter and regular maintenance are required.

WARNING! Water pressure should be reduced to 15 PSI for proper generator operation and to avoid leaks or crack in water filter. Installation must be done in the following order:

- 1 Pressure Reducing Valve*
- 2 Water Filter *
- 3 Water Supply Stop Valve *
- 4 Steel Braided Hose *

* Available with the Quick Connect Install Kit

Illustration 1.4

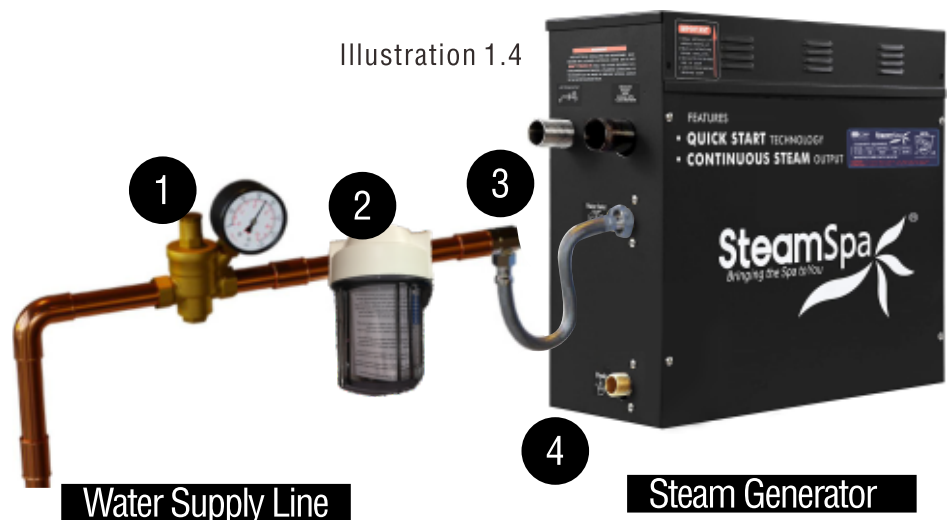

Water Supply Line

Steam Generator

INSTALLATION DRAWING OF DUAL STEAM GENERATORS

Illustration 1.5

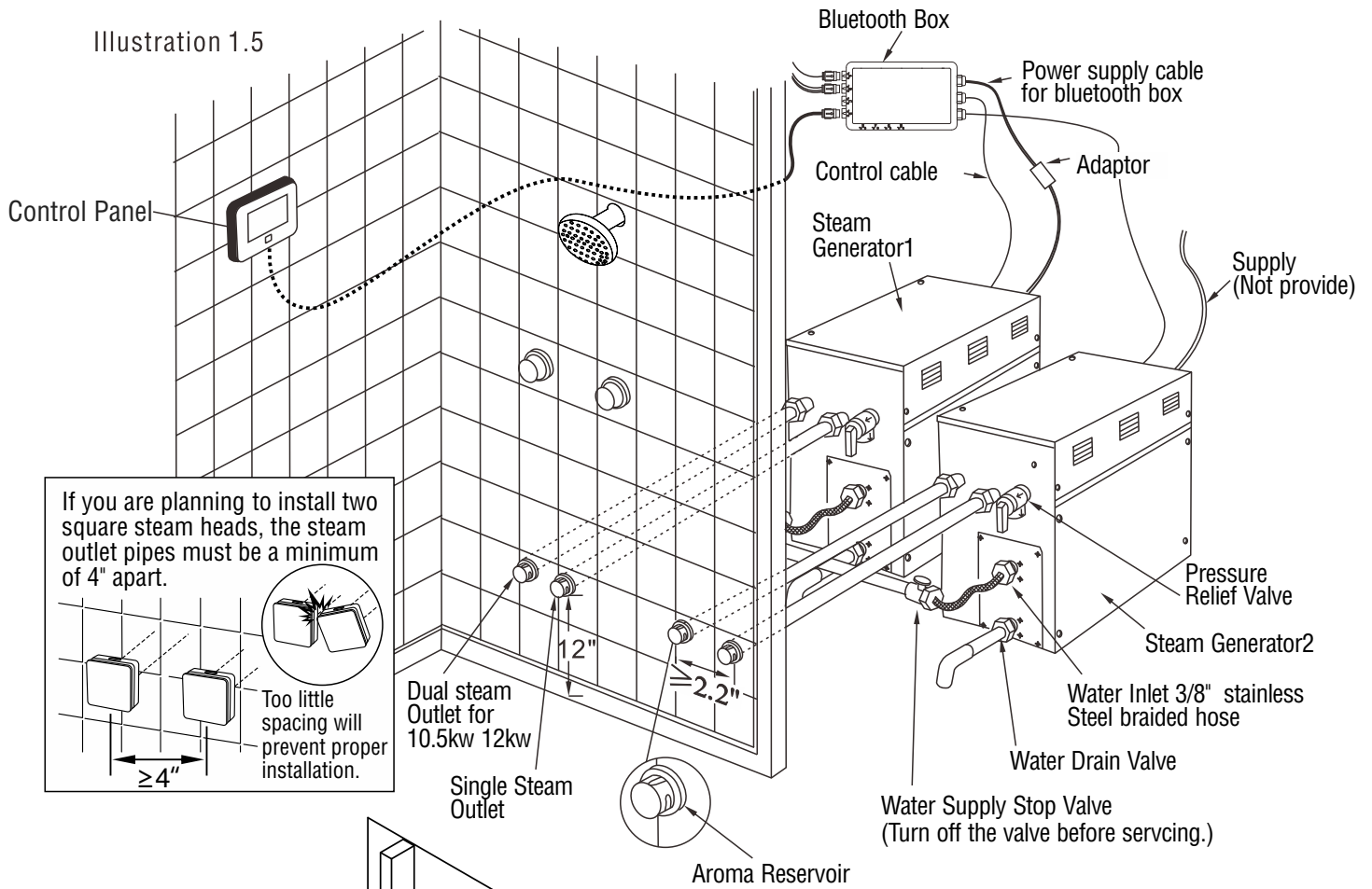

If you are planning to install two square steam heads, the steam outlet pipes must be a minimum of 4" apart.

Too little spacing will prevent proper installation.

≥4"

WARNING! For the dual installation, each unit must have its own dedicated line (240V) .

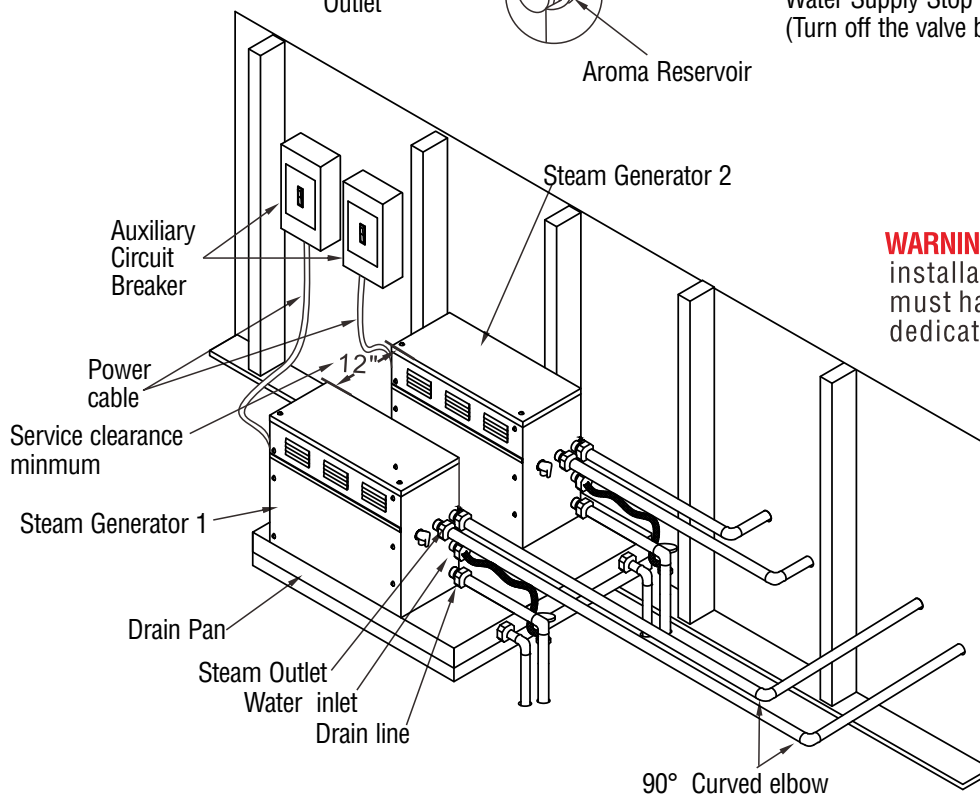

Illustration 1.6.1

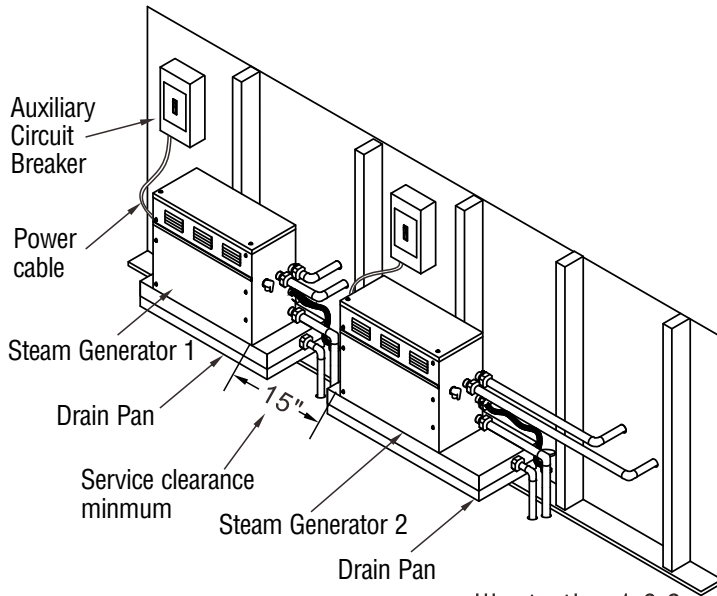

Illustration 1.6.2

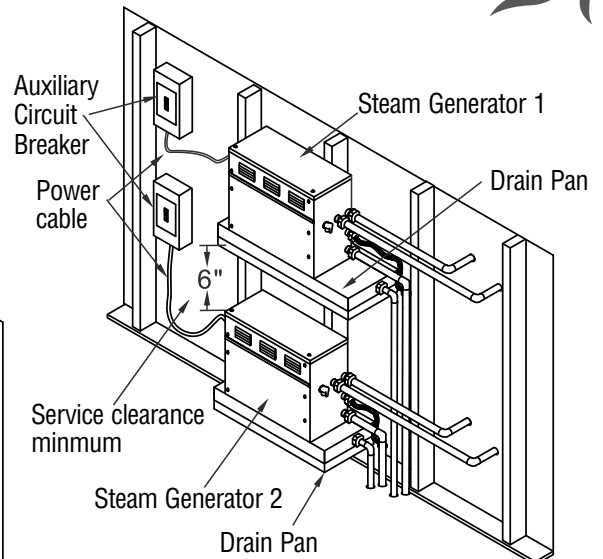
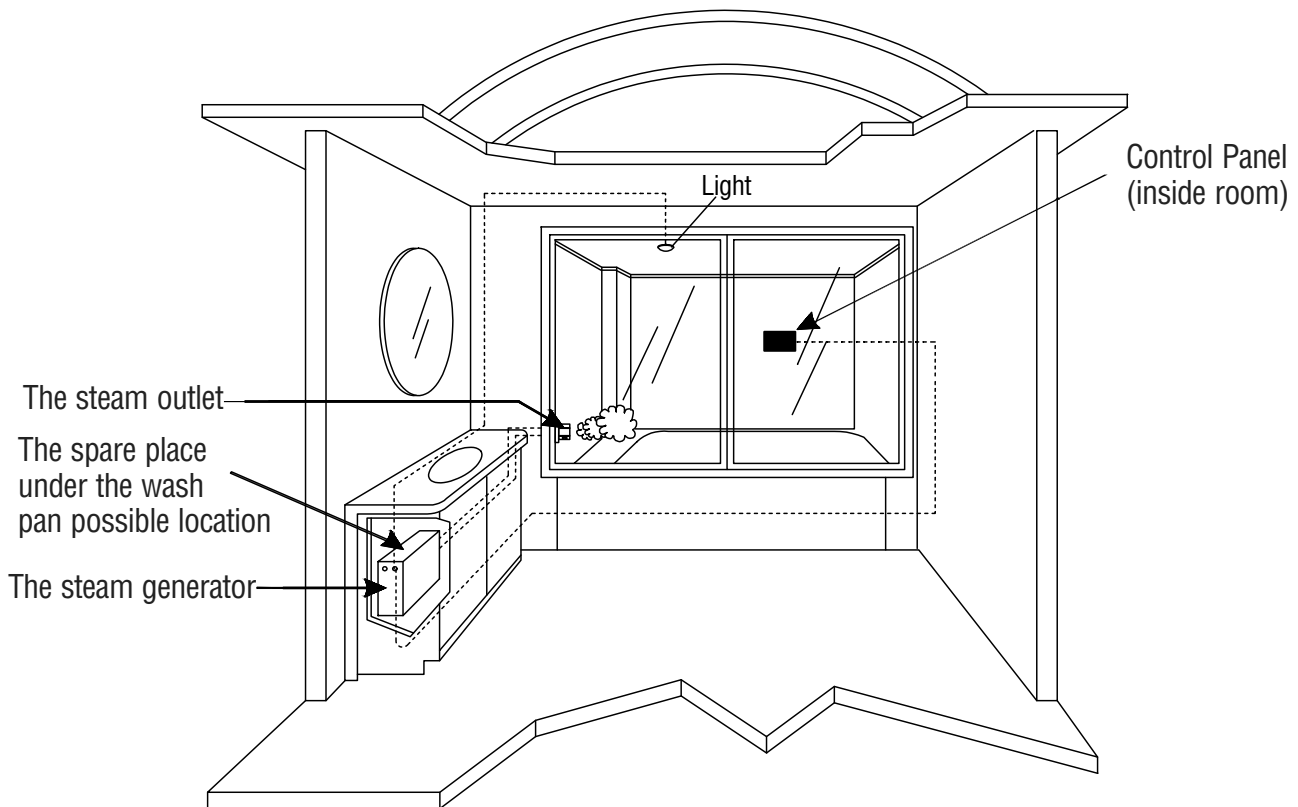

Illustration 1.6.3



ATTENTION! The illustration is just an example; the practical installation must comply with the nation's electrical criteria, and be done by a professional electrician.

The steam generator maybe installed in these location.

1. In closet located behind the shower.
2. In Attic
3. In basement.etc

ATTENTION! If the installation of the steam generator is more than 10 to 15 feet away from the steam room. It is recommended to increase the size of the generator 1 or 2 kilowatts higher to increase the steam flow.

PLUMBING INSTALLATION

WARNING! The installation of all water supply lines should be in accordance to all national and local codes by a licensed plumber.

1. Use copper fittings when connecting pipes.
2. Use brass pipes or copper pipes only. Do not use black and galvanized or PVC pipes.

ATTENTION! Please ensure a quick connect and release system is employed when installing steam generator to plumbing. Doing so will ensure quick and easy access to the generator for regular care and maintenance and is a critical condition for an active SteamSpa Warranty protection.

WATER SUPPLY PIPE (1/2")

Connect pressure reducing valve with pressure gauge, water filter, water supply stop valve, hose between hot water or cold water supply and generator. See page 10 illustration 1.2 and page 11 illustration 1.4.

ATTENTION!

1. The inlet water should not exceed 160°F.
2. The water supply stop valve should be installed in a place where is easily accessible.
3. Flush the water supply line completely before connecting the water pipe to the steam generator, to remove any sediments in the water supply line.
4. The water supply stop valve should be open approximately 25% to reduce water pressure to the generator. The water pressure to the generator should be between 15 to 20 PSI. if necessary, decrease the pressure accordingly.
5. A hydro pneumatic pressure reducing valve must be installed. The SteamSpa quick release & pressure reducing kit comes with a pressure reducing device calibrated to work with any SteamSpa generator unit.
6. Do not use PEX or PVC pipes.

INLINE WATER FILTER

WARNING! When installing an Inline Water Filter, it is imperative that the water pressure entering the filter is reduced to 15 to 20 PSI to avoid any leaks or cracks.

STEAM PIPE (3/4")

1. Do not install any stop valves in the steam pipes. The steam can't be obstructed.
2. Install 3/4" copper or brass pipe between the steam generator and the steam nozzle.
3. If needed, the heat insulation material used to insulate the steam pipe should be resistant to temperatures as high as 240°F or higher.
4. The shorter the distance, the better. Use curved elbows when connecting pipes to allow the steam to flow smoothly through the steam pipe.
5. The steam line must slope to allow condensation to drain into the tank or room.
6. There must be no dips in the steam line. Low areas may collect condensation and cause faulty operation or cause hot water to spit into the room.

STEAM HEAD (3/4")

ATTENTION! Steam Head is very hot when there is steam coming out, please install steam head in a place where it is away from the user.

1. Install the steam head approximately 12 inches above the ground floor. If the steam room material is acrylic or non-heat-resistant sheet, please consult material manufacturer about steam room applications.
2. The steam head outlet should be installed downward to avoid scalding.

ATTENTION! Tighten steam head by hand. Do not use a spanner or other tools. Use soap water and soft sponge to clean, and do not use erosive chemical solutions or crude cleaning tools.

IMPORTANT!

1. Please consult manufacturer of materials like acrylic, fiber glass or other anti-heat sheet about the installation of the steam head.
2. In the entire steam room, it is required that steam does not leak out. The pipes, its accessories and the holes should be air proof by applying sealant so that no steam will enter the holes in the wall.

DRAINPIPE (1/2")

ACCORDING TO THE NATIONAL AND LOCAL PLUMBING CODES: The steam generator drain valve should be equipped with a drainpipe. The steam generator drains the water by gravity. Check local code requirements for drain valves. Do not connect the pressure relief valve or steam line to drain line.

PRESSURE RELIEF VALVE (3/4")

1. Pressure relief valve is an automatic system that is activated by pressure in order to avoid steam pressure increase inside the generator.
2. The pressure limit range of the pressure relief valve is 15 PSI. The pressure will begin to decrease when it's higher than 15PSI and the pressure relief valve is activated.
3. If it is allowed by local codes, provide the pressure relief valve with exterior drainpipe.
4. Do not dismantle the pressure relief valve while generator is in operation.
5. To maintain the proper automatic operation of the pressure relief valve, make sure its connection pipe is smooth.

ASSEMBLY GRAPH FOR POWER WIRE

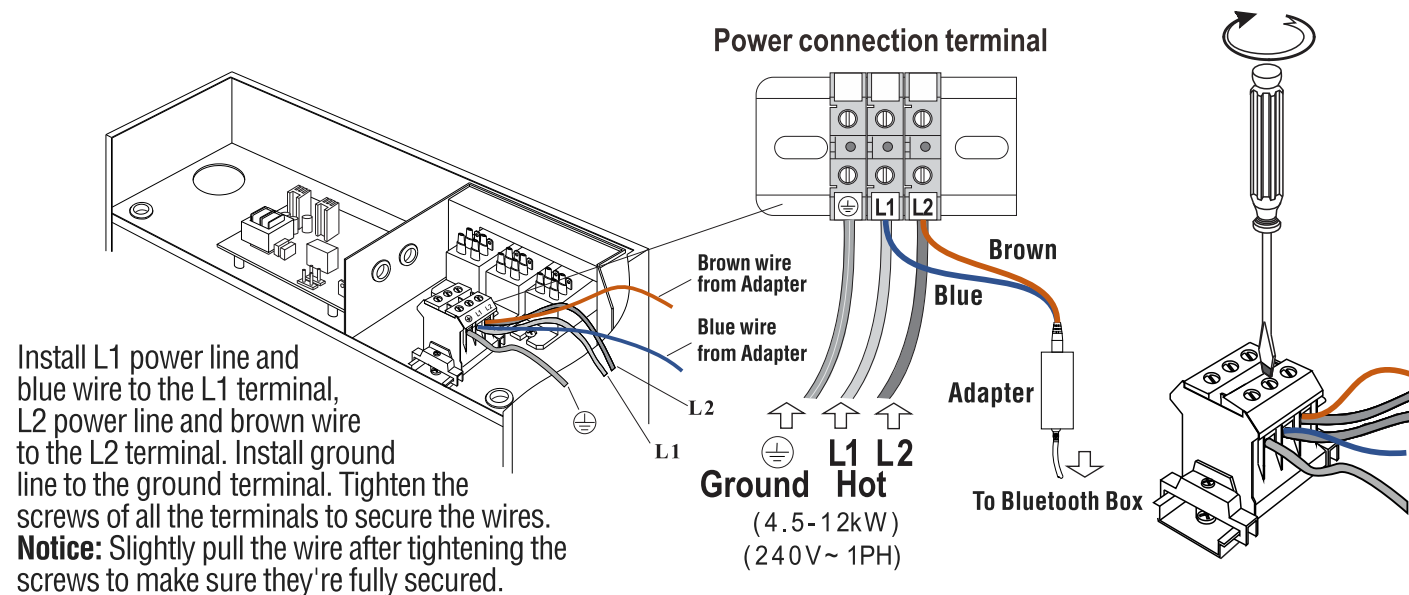

ATTENTION! To avoid damage to the equipment, do not connect electric current directly to heating elements.

WARNING! This graph is for explanation only. For actual installation, refer to national and local electricity consumption codes by professional electricians.

WIRING DIAGRAM

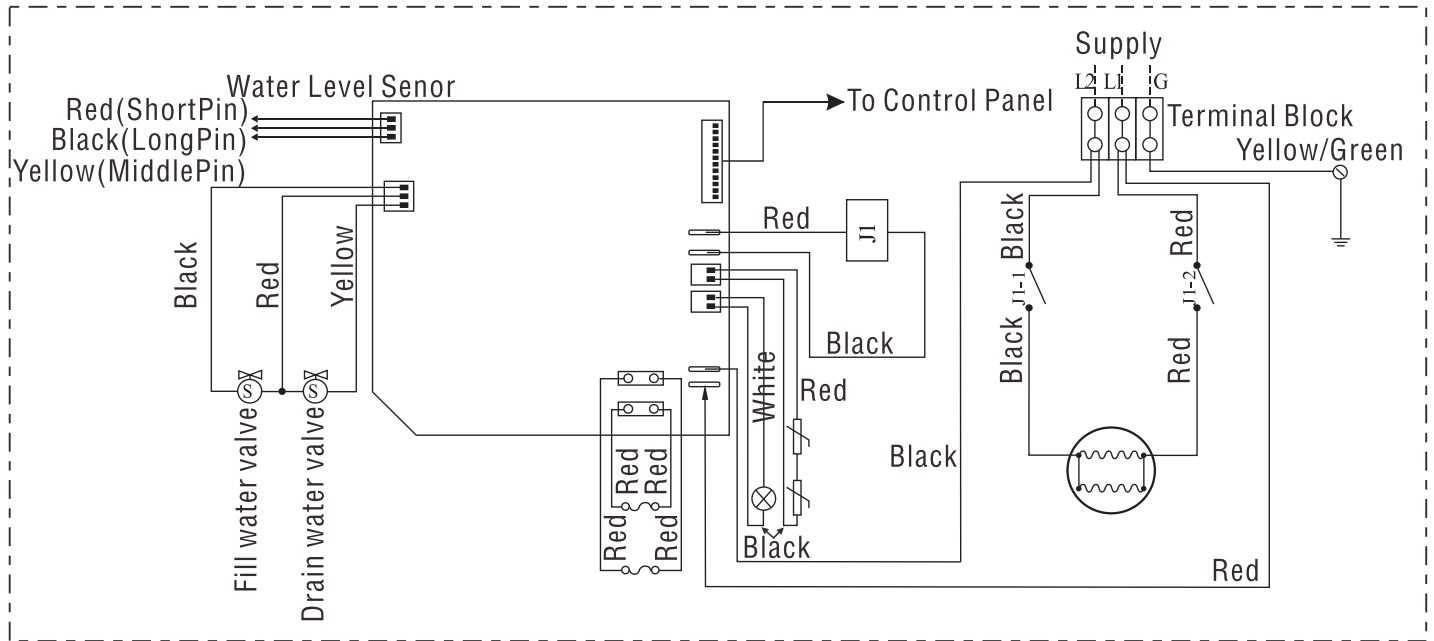

B02-450

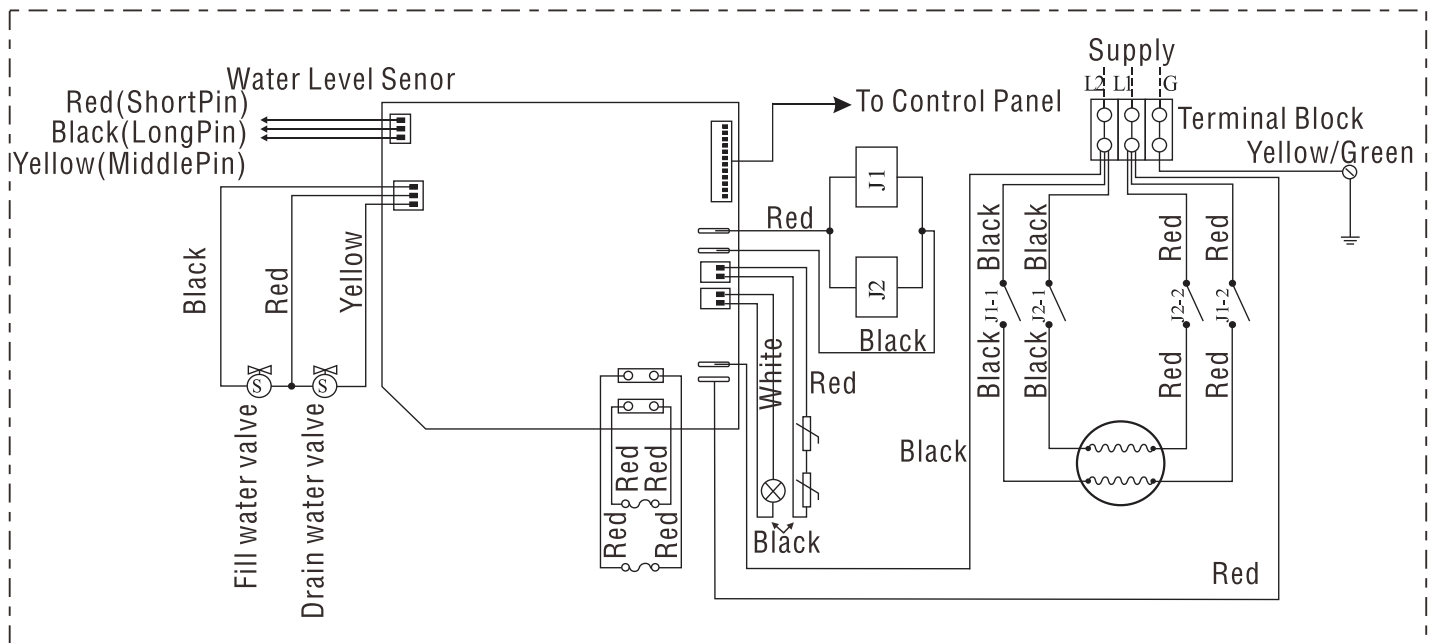

B02-600

WIRING DIAGRAM

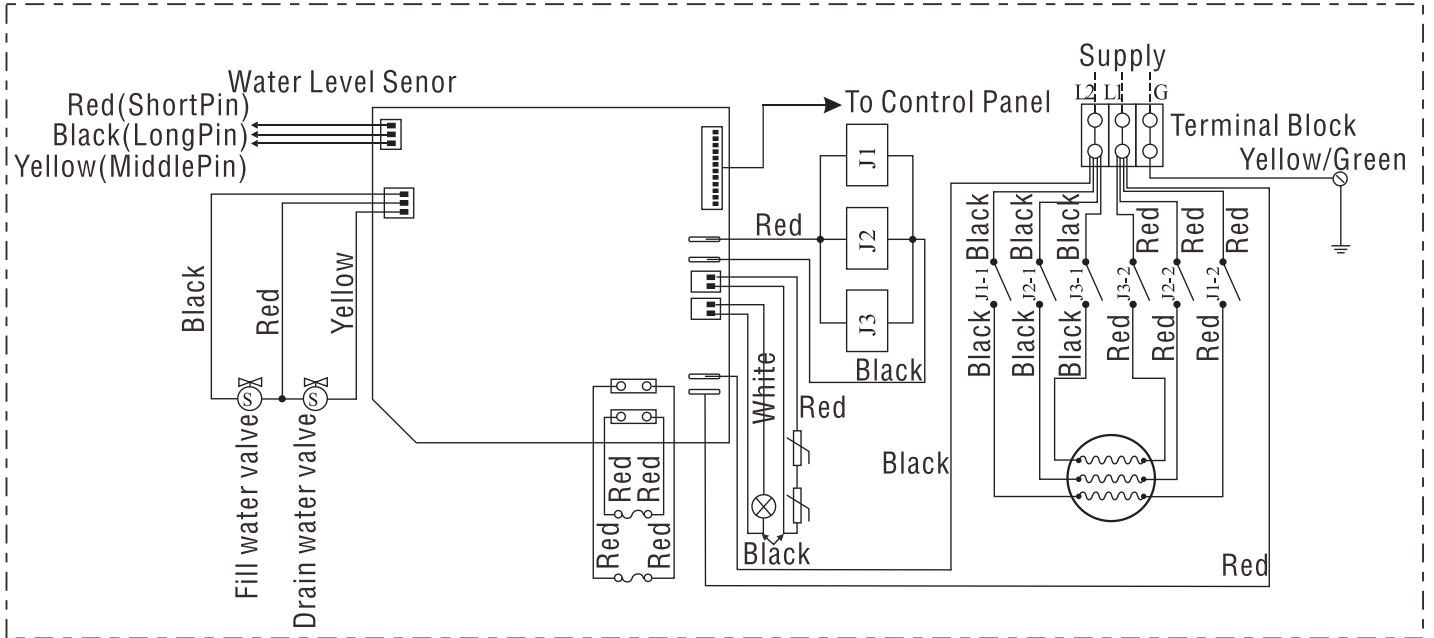

B02-750 B02-900

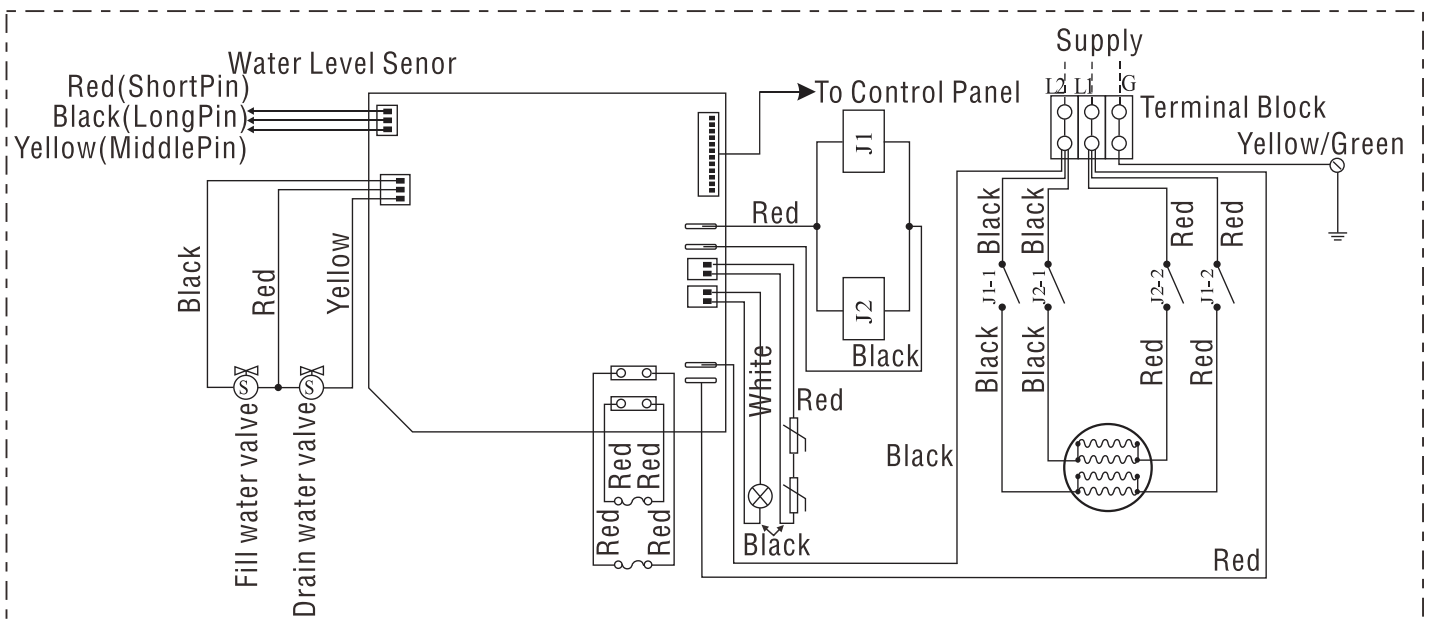

B02-1050 B02-1200

STEAM GENERATOR DISSECTION DIAGRAM

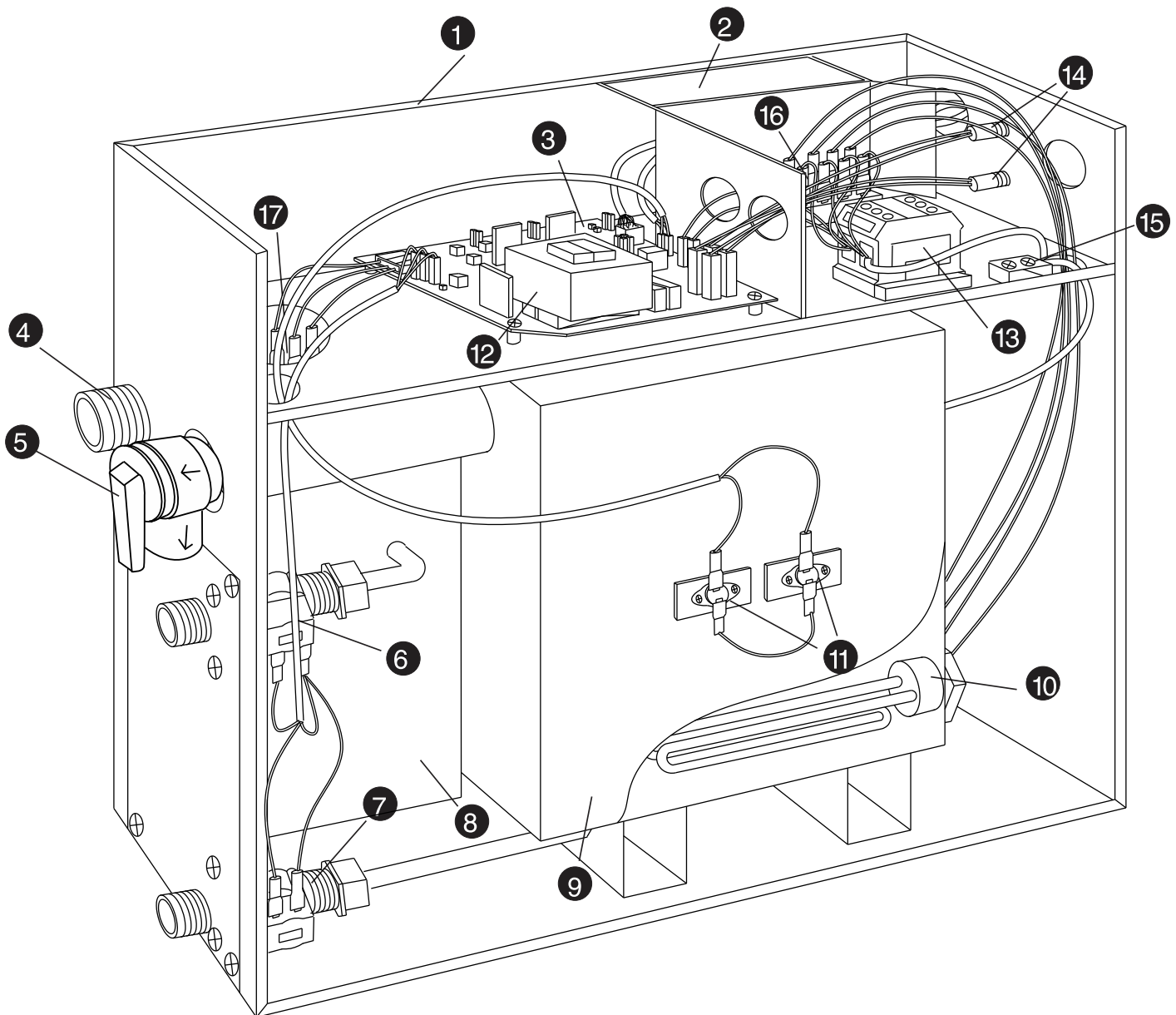

- | | | |
|--------------------------|--------------------------|---------------------------|
| 1. ENCLOSURE | 7. WATER DRAIN VALVE | 13. TERMINAL BLOCK |
| 2. INSULATION BRACKET | 8. SUBSIDIARY WATER TANK | 14. FUSE |
| 3. CIRCUIT BOARD | 9. MAIN WATER TANK | 15. GROUND WIRE CONNECTOR |
| 4. STEAM OUTLET | 10. HEATING ELEMENT | 16. RELAY |
| 5. PRESSURE RELIEF VALVE | 11. OVER TEMP. SENSOR | 17. WATER LEVEL SENSOR |
| 6. WATER FILL VALVE | 12. TRANSFORMER | |

CARE & USE FOR THE CONTROL PANEL

1. Use soft cloth with a little soap water to clean the control panel.
2. Do not use crude cleaning tools.
3. If the decorating facade is damaged, contact service electrician to change it.

Do not install any SteamSpa controls without reading and understanding the SteamSpa generator Installation and Instruction manual. Failure to read and understand these instructions will result in inoperative control, hazardous overheating, and/or inadequate heating of the steam room.

Do not route control wire inside or close to power lines conduit, hot water or steam piping. Doing so may result in wire damage.

Do not install SteamSpa controls with other than SteamSpa compatible steam generators. Doing so may result in possible generator damage or inoperative installation.

Control Panel with Temperature sensor must be installed inside bathing area 5 feet above floor. Do not install Control Panel directly above Steam Head or below shower head but rather in the seating area on a vertical wall. Doing so may result in improper temperature reading and/or inoperable control.

Turn power to the steam generator off before connecting the control to the generator. Failure to turn the power off connecting control panel will result in an inoperable control.

Discontinue use of the steam generator or control panel if the steam generator is damaged.

CONTROL SYSTEM COMPONENTS

Option 1 (GS08TA)

- One (1) SteamSpa Black Main Control panel
- One (1) Secondary Control panel (optional)
- Two (2) Chroma Color Light
- One (1) LED White Light
- One (1) SPA FCC Certification Manual
- Two (2) Speakers
- One (1) Control Box
- Six (6) Extension Cables
- User guide

Option 2 Wireless Full Function (WTPFFMK)

- One (1) SteamSpa Black Control panel
- Two (2) Chroma Color Light
- One (1) LED White Light
- One (1) SPA FCC Certification Manual
- Two (2) Speakers
- One (1) Control Box
- One (1) Receiver
- Six (6) Extension Cables
- User guide

Option 3 Wireless Controller (WTPMK)

- One (1) SteamSpa Black Control panel
- One (1) SPA FCC Certification Manual
- One (1) Receiver
- One (1) Extension Cables
- User guide

CONTROLLER SPECS

GS08TA

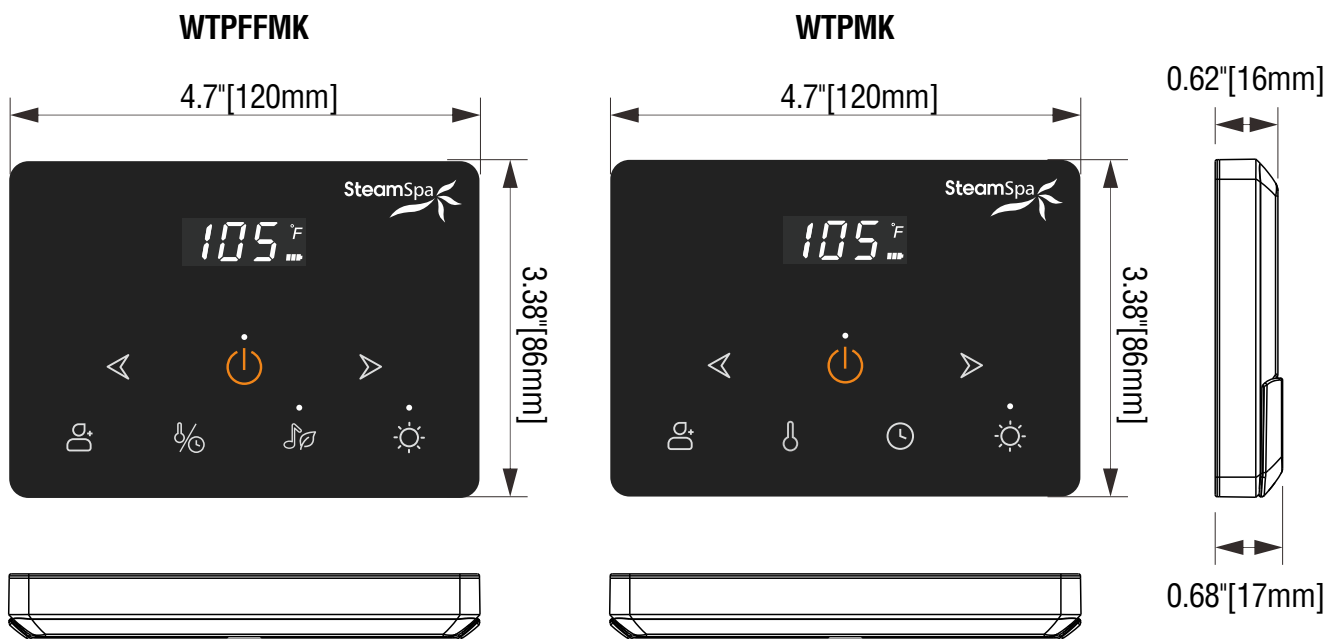
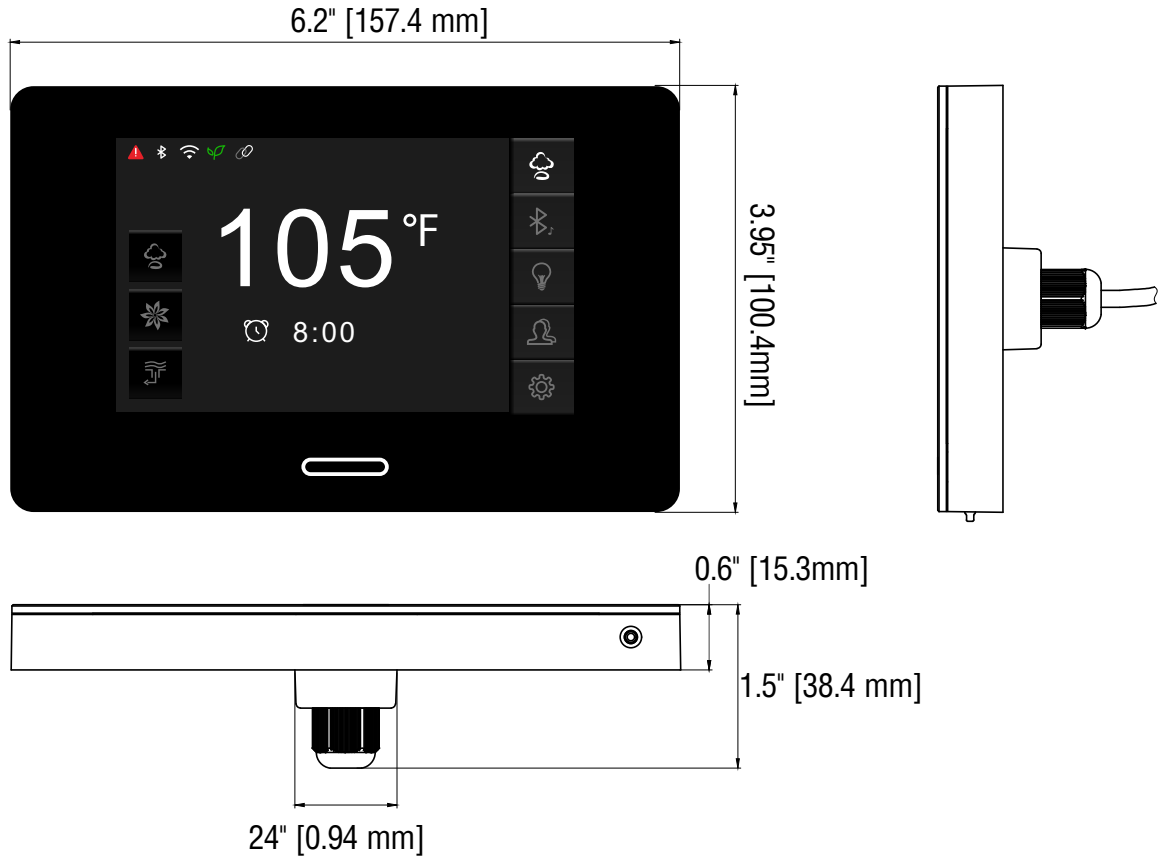

CONTROL PANEL INSTALLATION INSTRUCTIONS

GS08TA

Determine the installation location of the control panel. The master control panel is designed to be installed in the steam room only, please install:

1. 4-5 feet from the ground.
2. Keep away from the steam head and do not expose under the direct spray of steam.
3. Install in the perpendicular wall.
4. The position of installation should facilitate easy operation and convenient wiring.

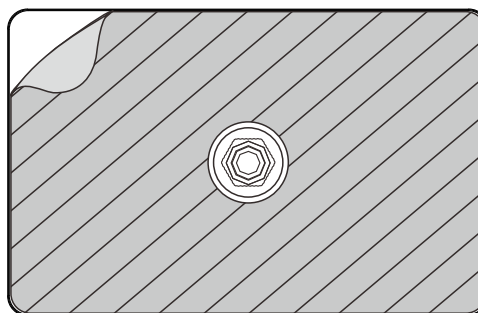
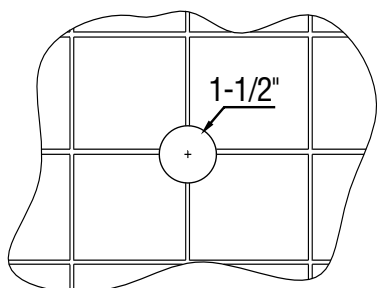

STEP 1

Drill a 1-1/2" hole on the wall at the center of the Control Panel's location.

STEP 2

Remove the film from one side of the sticker and stick it at the back of Control Panel. Remove the film from the other side of the sticker.

STEP 3

Slide the cables of the Control Panel through the hole drilled on wall, then stick the Control Panel to the wall. Apply good quality silicon sealant to the corner formed by the wall and Control Panel.

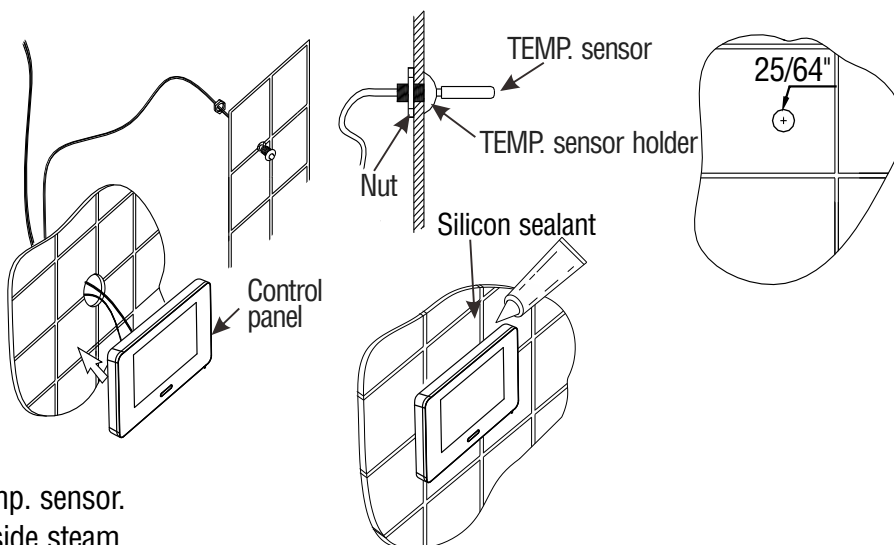

Notice: The Control Panel is integrated with temp. sensor.

It's no need connecting an extra temp. sensor.

When Control Panel is installed outside steam

room, please install an extra temp. sensor inside the steam room by referring to figure shows above and steps below.

- a. Drill a 25/64" hole on the wall at the location of the temp. sensor.
- b. Remove the nut from the TEMP. Sensor Holder and install it from the front of wall. Then secure it by tighten the Nut from the back of the wall.
- c. Slide the cable of it through the hole of the TEMP. Sensor Holder and push it until it stop.
- d. Connect temp. sensor to the Control Panel.

WIRELESS Control Panel Installation Instructions

WTPFFMK / WTPMK

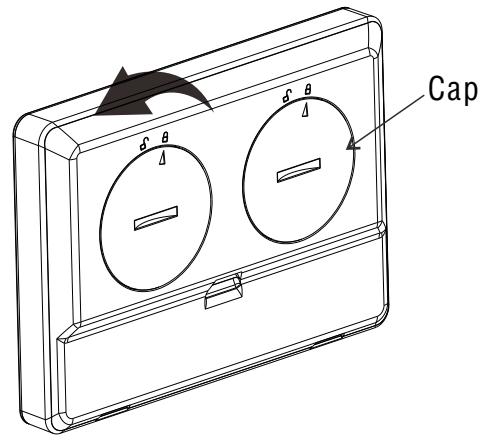
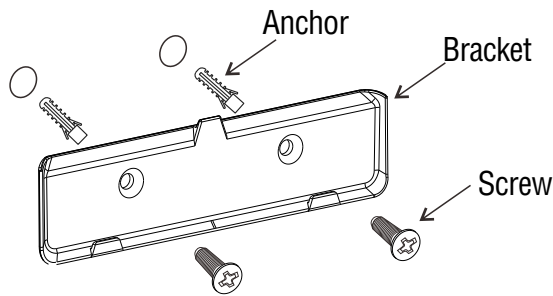

STEP 1

- Identify the mounting location of the bracket.
- Mark the screw holes once the desired location is determined.
- Drill 7/32" holes on the wall and install anchors.
- Secure the bracket with screws as figure shows above.

STEP 2

Use a coin to turn the caps in counter-clockwise behind the Control Panel to remove them.

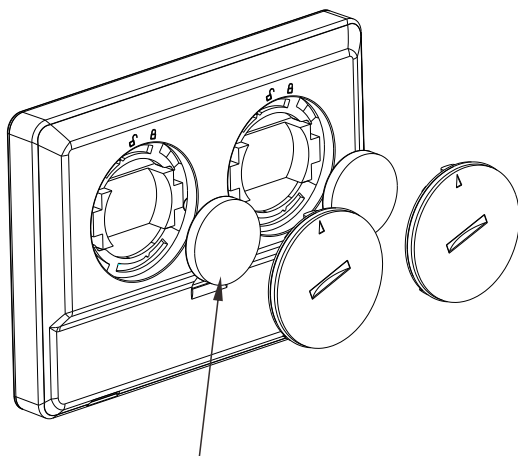

CR2450 3V Lithium Batteries

STEP 3

- Install two CR2450 3V Lithium Batteries into the Control Panel.
- Install the caps back and use the coin to turn the caps in clockwise to secure.

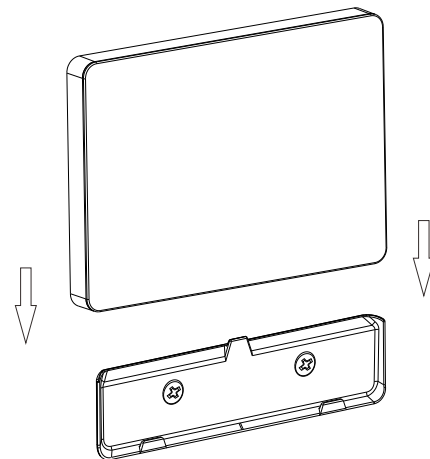

STEP 4

Slide the Control Panel to the bracket to complete the installation.

INSTALLING LIGHT

CAUTION! Installer must take some moisture proof measures in the process of installation. Electrophorus components cannot be exposed to moisture, as it will cause damage to the light components causing a possible short circuit.

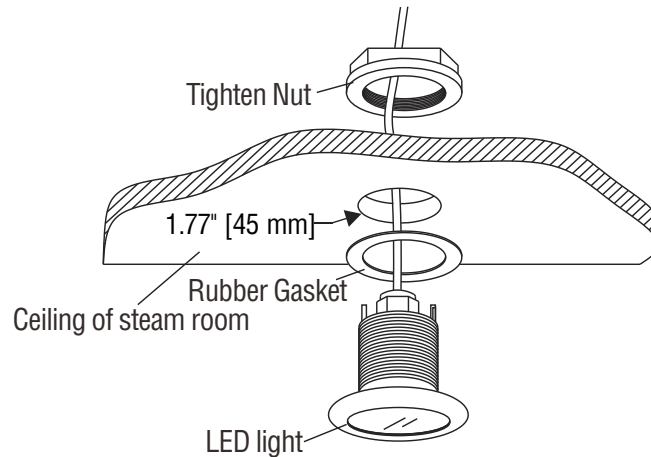

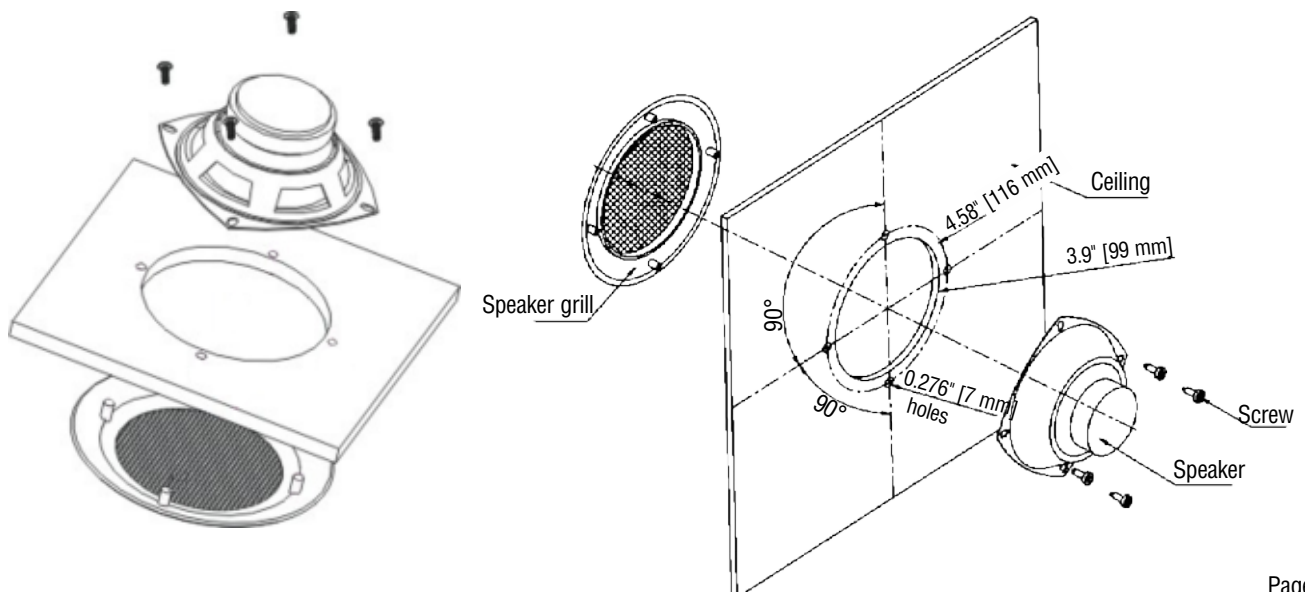

INSTALLING SPEAKERS

1. Choose a proper place on ceiling inside the steam room.
2. Drill holes through the ceiling as the picture shows.
3. Choose the screws according to the thickness of the ceiling or the plate where the speakers are installed. Use #4 x 1/2" phillips pan head self-tapping screws for ceiling with 1/2" thickness. Use #4 x 3/8" phillips pan head self-tapping screws for ceiling with 3/8" thickness. The length of screws should be neither less than 2mm nor longer than the thickness of the ceiling. When the thickness of ceiling is less than 4mm, add one or more 1/4 flat washers between the ceiling and the speakers. Install the speaker grills from the bottom and the speakers from the top of the ceiling. Tighten the screws to secure the speakers. **Do not over tighten.**



TESTING THE MACHINE

GS08TA

1. Turn on the water supply stop valve. Turn on the breaker connecting to steam generator system. Press  to turn on Control Panel.
2. It will takes 1 - 2 minutes to fill up and heat the water. After that the steam comes out.
3. Press  again to turn off the steam generator. The light goes off automatically.
4. The temperature reading on the control panel goes up as the steam keeps coming out into the room. When the temperature of the room reaches the preset value, the steam stops.
5. When the set steam time is up, the system will shut off the steam and light automatically. Water input stops.
6. Once the timer is finished, or the generator is manually turned off, and stays off for 2 hours, the auto drain function will automatically begin draining. Auto drain function will last for 5 minutes.

WTPFFMK / WTPMK

1. Turn on the water supply stop valve. Turn on the breaker connecting to steam generator system. Press  to wake up the Control Panel and start steam generator. The screen shows room temperature and the LED indicator is on. The Control Panel will be in standby if there isn't any operation in 10 seconds. It will takes 1 - 2 minutes to fill up and heat the water. After that the steam comes out.
2. Lights, RGB light, aromatherapy, Bluetooth music and other function keys respond properly when pressed once.
3. The temperature reading on the control panel goes up as the steam keeps coming out into the room. When the temperature of the room reaches the preset value, the steam stops.
4. Once the timer is finished, or the generator is manually turned off, and stays off for 2 hours, the auto drain function will automatically begin draining. Auto drain function will last for 7 minutes.

WARNING! Do not dismantle the pressure relief valve arbitrarily.

IMPORTANT! Do not switch the water input pipe when the steam generator is working.

CONTROL PANEL DESCRIPTION

Model: GS08TA

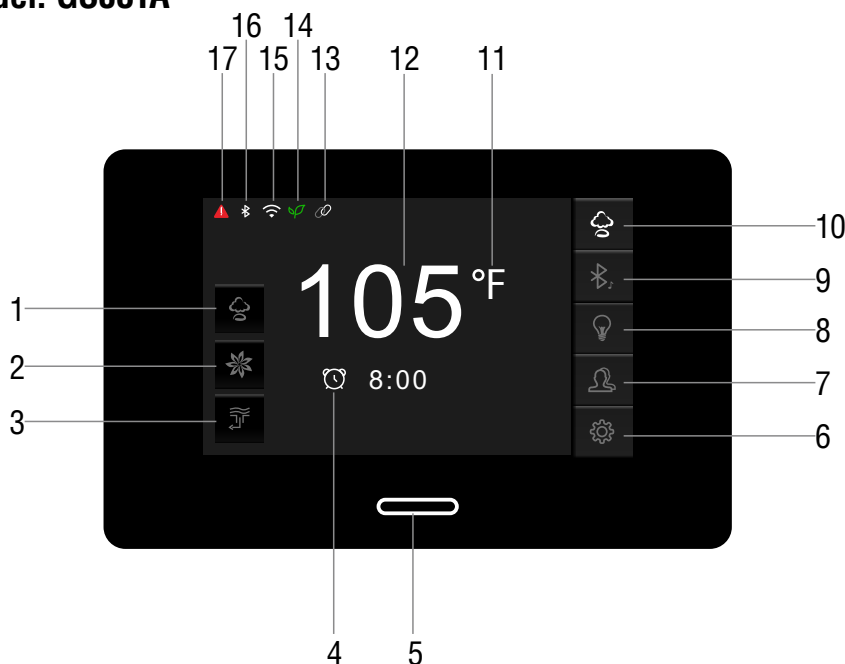

1. Steam on/off
2. Aroma on/off
3. Drainage on/off
4. Steam Time setting
5. Power on/off
6. Settings
7. User Presents
8. Light Controls
9. Bluetooth Controls
10. Steam Controls
11. TEMP. unit
12. Steam TEMP. setting
13. Bluetooth Connection Built Up
14. ECO Mode
15. Wifi Connection Built Up
16. Bluetooth Icon
17. System Failure Warning

OPERATION

Model: GS08TA

⚠ ATTENTION

1. Water mist on screen surface will affect the touch effect. Normal operation can be resumed after water mist is removed;
2. The control panel surface is made of glass. Do not rub with hard objects, and pay attention to the front protection.

FUNCTIONS



LIGHT



STEAM



AROMA PUMP



SECONDARY ON/OFF CONTROL



BLUETOOTH



CHROMA LIGHT



WIFI



CLEAN

OPERATIONAL APPROACH

1. START-UP/SWITCH OFF

POWER ON

- A. Turn on the breaker connecting to steam generator system. Press  to turn on Control Panel. If the Control Panel has been set password, it will need password to unlock after power on. (Figure 1)
- B. If system has been preset operation time, the system will be powered on and operated according to preset "USER 1" parameters automatically.

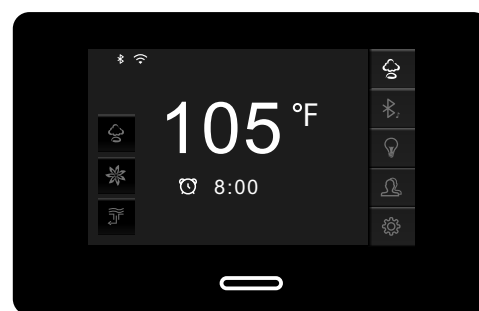



Figure 1



POWER-OFF

- A. When system is on, press  to turn off the system. The screen of Control Panel will be off. If the clock function is on, the screen will show real time clock after system shut down.
- B. When the preset operation time is up, the steam function stops and the system will be shut down after 2 minutes.

WATER DRAINAGE

Once the timer is finished, or the generator is manually turned off, and stays off for 2 hours, the auto drain function will automatically begin draining. Auto drain function will last for 5 minutes. When the system is on and steam function still not be activated, press  to drain water for 10 minutes manually.

2. LIGHTS

When control panel is on, press  on the right of the screen to enter light control interface. Press  on the bottom left corner to turn on/off the light. (Figure 2)

Chroma lights control

Slightly press the dot on the circle and slide it along the circle. The color of  in the middle of circle changes simultaneously and reflect the color of the chroma light.

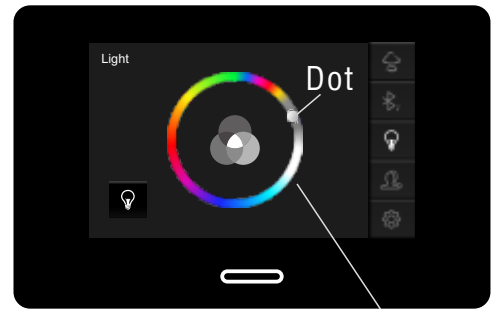



Figure 2 Circle

3. STEAM FUNCTION

When control panel is on, press  on the left of screen to turn on/off the steam function. (Figure 3)

Steam temperature setting

When the steam function is on, the icon of  is lightened. Press the temperature in the middle of the screen, there is a small interface jumped out. You can slide it up and down to set the room temperature between 77 °F - 154 °F(25 °C - 68 °C).

When the ECO mode is activated, the highest room temperature would be limited to no more than 122 °F(50 °C).

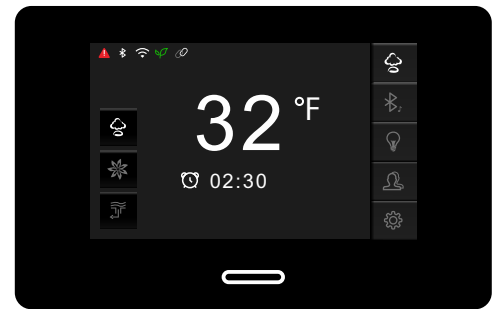







Figure 3

Steam time setting

When the steam function is on, the icon of  is lightened. Press the time in the middle of the screen, there is a small interface jumped out. You can slide it up and down to set the steam time between 30 minutes to 25 hours.

4. BLUETOOTH MUSIC

- When control panel is on, turn on the bluetooth function on your mobile phone and connect to " **SteamSpa** ". When the connection is success, the screen of steam interface will show .
- When the connection is succeeded, prees  on the right of the screen to enter bluetooth player.
- Turn on the music player on your mobile phone. Then you can play the music by pressing  on the middle of screen.
- When the music is playing, press  or  to switch to the previous song or the next song. (Figure 4)

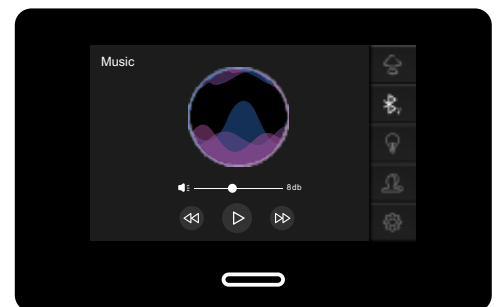

Figure 4



Slightly press the dot  and slide it to adjust the volume of the song.

Dot

When steam generator connected with Bluetooth music box,  shows at the top of screen.

Bluetooth stop connection after 10 seconds starting from steam generator is powered off. When steam generator restart after 10 seconds, need to reconnect mobile's bluetooth.

5. USER PREFER MODEL SETTING

- Press  to enter to the "User prefer mode". (Figure 5)
- Press  on the right, a small window jumps out to set the room temperature and steam time. (Figure 5)
- Press "Set" at the bottom of small window to confirm the setting. (Figure 6)
- Press  which is corresponding to the settings and press "Save" at the bottom of the small window to save the settings. (Figure 7)

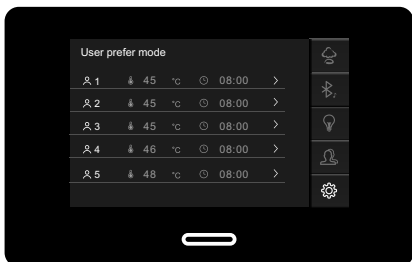

Figure 5

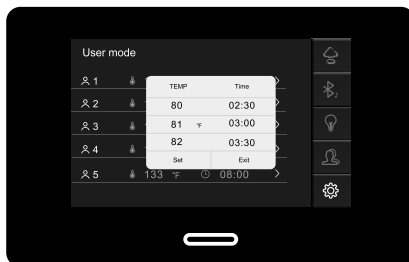

Figure 6

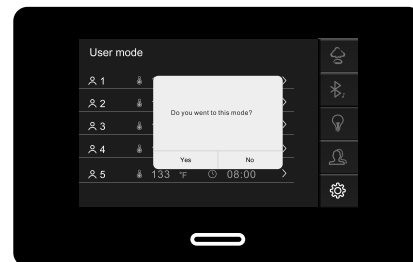



Figure 7



6. SETTINGS

Press  to enter settings interface. (Figure 8)

Working mode

- Press  on the right of "Working mode" to enter "Preset timing" interface. (Figure 8)
- Press the dots to set the running day of each week. "OFF" means the system won't operate that day. "ONE" means the system will operate once that day. "REP" means the system will be operated repeatedly until manually shut down. (Figure 9)
- Press the time on the top of screen and roll up and down to set the specific start time of system. (Figure 9)
- Press "Set" to save the setting and go back to setting interface. (Figure 9)

Real-time clock

- Press  on the right of "Real-time clock" to enter "Real-time clock" interface. (Figure 10)
- Press the figures which need to be adjusted, there are small interfaces jumped out. You can slide them up and down to set the date, day and time. (Figure 10)
- Click the  at the front of "Show real time" for showing the clock when the control panel is in standby mode. (Figure 10)
- Press "Set" to save the setting and go back to setting interface. (Figure 10)

°F/°C switch

Press  on the right of  to switch between Fahrenheit and Celsius. (Figure 8)

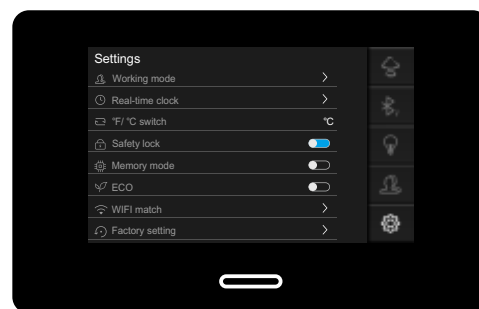

Figure 8

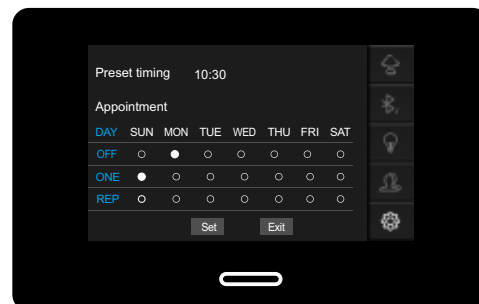

Figure 9

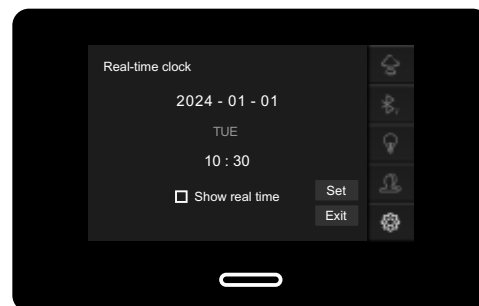



Figure 10

Safety lock

Press  on the right of . A small window jumps out. Input a four digit number and press ok to exit. When the Control Panel is waken, it will need to input this four digit number to enter the Control Panel.(Figure 8, Figure 11)

Notice: If the password is forgotten, you can input **2580** to access the Control Panel. Power on by preset working time or APP are not limited by the safety lock.

Press  on the right of  will turn off the safety lock.

Memory mode

When  on the right of  is off, The system will be limited to be operated in 8 hours and 113°F (45°C). (Figure 8)

When  on the right of  is on, The system will be operated by following the settings of user. (Figure 8)

Notice: Memory mode default off.

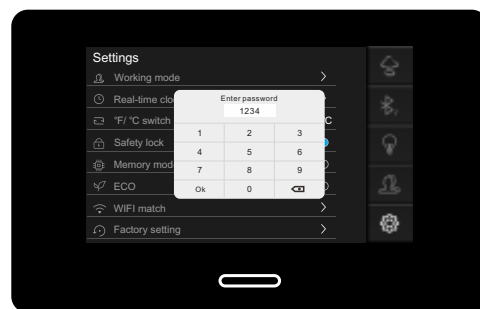







Figure 11

ECO

Press  on the right of . The system will be limited to be operated in 122°F(50°C).  will be showed on the screen. (Figure 8)

Factory setting

Press  on the right of . A small window jumps out. Press "YES" to restore the system to factory settings. Press "NO" will stop restoring. (Figure 12)

Notice: After all the setting is done. Press  on the right of the screen to switch back to the steam interface. (Figure 12)

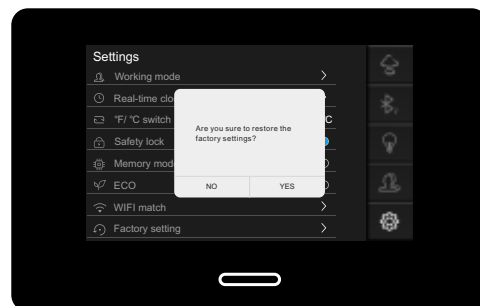



Figure 12

7. AROMA PUMP

- Press  to enter aroma pump operation interface. (Figure 3)
- Press  will allow aroma outlet **A** or **B** working according to the setting. (Figure 13)
- Press the time of **A** or **B**, a small window jumps out. The time on the left will set the stop time of aroma outlet **A** or **B** form 1 minute to 10 minutes. The time on the right will set the working time of aroma outlet **A** or **B** form 1 second to 9 seconds. Press "OK" to save and exit. (Figure 14)
- Press "Start" to start the aroma generator. (Figure 13)

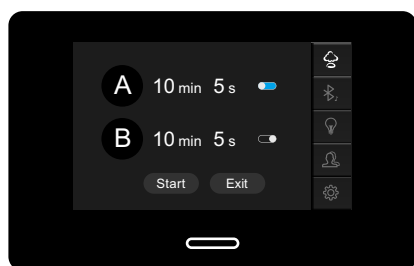

Figure 13



Figure 14

OUTSIDE SECONDARY ON/OFF CONTROL

Note: Outside secondary On/Off control is not standard part for Control Panel, it's optional.

Steam generator can be powered ON/OFF by Outside secondary on/off control. The backlight of the sub panel indicates different working states.



Light status	Status Description
Blue light flashing	Communication failure, check cable connection
Red light flashing	Steam engine alarm
Blue light on	Power on but not steam out
Purple light on	Steam engine on, heating up
Red light on	Ambient temperature has reached the preset temperature
Backlight turns off	Power off

1. When system is powered off, press outside secondary On/Off control to turn on the light and steam function.
2. When system is on, press button to stop steam and power off the light and button backlight at the same time.
3. Button is purple color for 2 seconds once outside secondary On/Off control power on. When outside secondary On/Off control can't receive signal from Control Panel in 5 seconds. Blue button backlight flashes. When Control Panel malfunctioned, red button backlight flashes.
4. When outside secondary On/Off control connected power, steam function still not work, button backlight is light blue. When steam works and room temperature is lower than preset room temperature, button backlight is purple. When room temperature reaches the preset room temperature, button backlight is red.

TECHNICAL PARAMETERS

Working conditions and characteristics				
Rated voltage	AC220-240V	Rated frequency	50/60Hz	
Component Parameters				
Parts	Rated voltage	Frequency	Rated power	Other
Steam machine	AC220-240v	50/60Hz	4.5-12KW	-
Light	AC220-240V	50/60Hz	200W	Steam machine output
Chroma	DC12V	-	≤15W	
Speakers	-	-	8Ω/5W*2	music box output

CONTROL PANEL DESCRIPTION

Model: WTPFFMK

1. User prefer mode
2. Reduce
3. TEMP./Time setting
4. Power ON/OFF
5. Bluetooth music / Aroma
6. Increase
7. RGB light
8. Screen
9. LED indicator

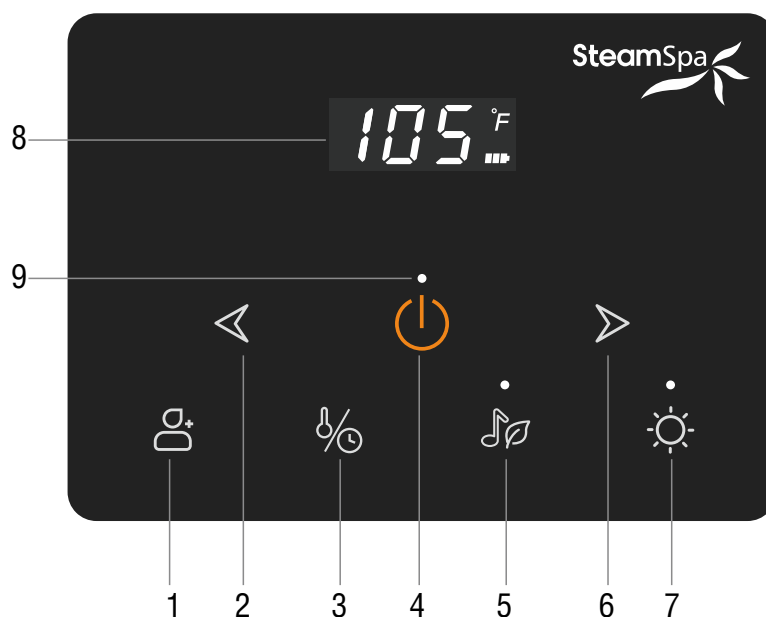

OPERATION

Model: WTPFFMK

FUNCTIONS

- | | | | | |
|----------|--------------|---------------|--------------|----------|
| 1. Steam | 2. User mode | 3. Aroma pump | 4. RGB light | 5. Music |
|----------|--------------|---------------|--------------|----------|

OPERATIONAL APPROACH

1. POWER ON

Turn on the breaker connecting to steam generator system. Press  to wake up the Control Panel and start steam generator. The screen shows room temperature and the LED indicator is on. The Control Panel will be in standby if there isn't any operation in 10 seconds.

2. POWER OFF

Press  once to wake up the Control Panel. Press  second time for 2 seconds to shut down steam generator system.





3. STEAM





The default steam generator system's working time is 30 minute and the default temperature is 110°F (43°C). User can change the steam time and room temperature. The system will save the settings.

Notice:

1. When the steam generator is short of water, the power indicator flashes.
2. When the Control Panel isn't activated, press  for 2 seconds will change the temperature from Fahrenheit to Celsius, press the button for 2 seconds will change back to Fahrenheit.

4. STEAM TEMPERATURE AND TIME SETTING







When the steam generator is turned on, press the button  to set the room temperature, the °F flashes. Press  or  will change room temperature between 50 - 130 °F (10 - 55°C). Keep pressing  or  to change the room temperature setting rapidly.

Pressing  the second time to set steam time. Pressing  or  will change steam time between 1-60 minutes. Keep pressing  or  to change the steam time setting rapidly.

5. USER PREFER MODE

When the Control Panel is activated, press  to select customized setting between U1, U2 and U3 for the system. After customized setting is selected, any setting change will be saved automatically. If there isn't any setting in 5 seconds, setting will be canceled and the screen will show the room temperature again.





6. AROMA PUMP

- When the steam generator is on and Control Panel is activated, press  for 2 seconds to turn on the aroma generator. The screen will show "ON". Indicator above  will be lightened with green color. When the Control Panel is activated, press  for 2 seconds to turn off the aroma generator. The screen will show "OFF".
- When the Control Panel isn't activated, press  for 2 seconds to set working time of aroma generator between 2 sec. to 10 sec.. Press  or  to adjust the time. The screen will show the preset working time.









Notice:

- The aroma generator only operated when the steam generator is working.
- The aroma generator works for 5 seconds and stop for 10 minutes.
- The indicator will be lightened only when the Control Panel is activated.

7. LIGHTS

When the Control Panel is activated, press  to turn on the Chroma Lights and the Light. The indicator above  is green. The color of Chroma Lights change automatically. Press  the second time, Chroma Lights will maintain current color. The indicator above  is white. Press  the third time, all the lights will be turned off.

8. BLUETOOTH MUSIC

- Turn on the bluetooth function on your mobile phone and connect to " SteamSpa ".
- Turn on the music player on your mobile phone. Then you can play the music by pressing  on the Control Panel. Indicator above  will be lightened with white color. The screen will show  for 3 seconds. If the bluetooth connection isn't good, the screen will flash . If the aroma generator is on at the same time, the indicator will change between green and white light. Press it again to turn off the music.
- Press  or  to adjust the volume.
- Press  for 2 seconds to switch to previous song. Press  for 2 seconds to switch to next song.

NOTICE:

1. To save the batteries of Control Panel, the screen of it will be up for 2 seconds with 1 minute intermittent to show the room temperature. When the Control Panel is activated, it will be off if there isn't any operations in 10 seconds.
2. Control Panel should stay with its bracket. If the Control Panel is removed from the bracket for 12 minutes, the system will be shut-down.
3. Once the timer is finished, or the generator is manually turned off, and stays off for 2 hours, the auto drain function will automatically begin draining. Auto drain function will last for 5 minutes.
4. When the batteries are used up, the screen of Control Panel will show **Lo**.
5. If the wireless Control Panel can't connect to the receiver in 5 minutes, it will shut down automatically.

CONTROL PANEL DESCRIPTION

Model: WTPMK

1. User prefer mode
2. Reduce
3. TEMP. setting
4. Power ON/OFF
5. Time setting key
6. Increase
7. Light
8. Screen
9. Indicating

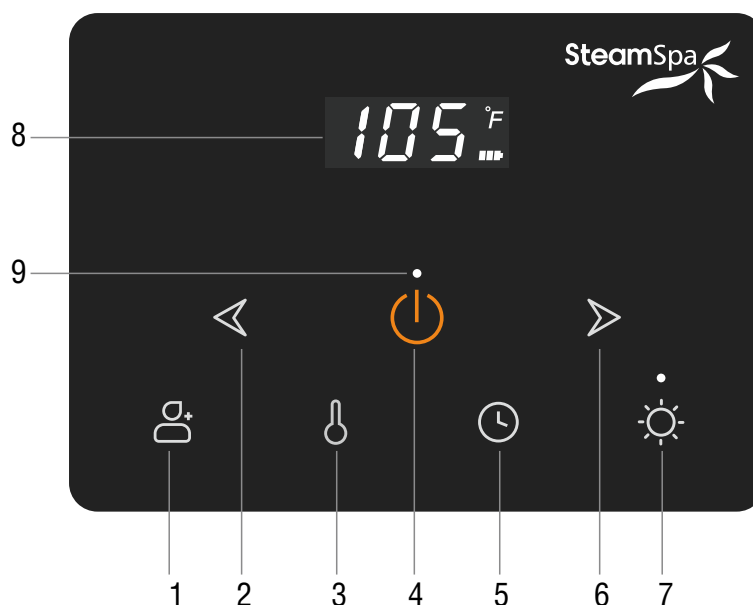

OPERATION

Model: WTPMK

FUNCTIONS

- | | | |
|----------|--------------|----------|
| 1. Steam | 2. User mode | 3. Light |
|----------|--------------|----------|

OPERATIONAL APPROACH

1. POWER ON

Turn on the breaker connecting to steam generator system. Press  to wake up the Control Panel and start steam generator. The screen shows room temperature and the LED indicator is on. The Control Panel will be in standby if there isn't any operation in 10 seconds.

2. POWER OFF





Press  once to wake up the Control Panel. Press  second time for 2 seconds to shut down steam generator system.

3. STEAM

The default steam generator system's working time is 30 minute and the default temperature is 110°F (43°C). User can change the steam time and room temperature. The system will save the settings.

Notice: 1. When the steam generator is short of water, the power indicator flashes.
2. When the Control Panel isn't activated, press  for 2 seconds will change the temperature from Fahrenheit to Celsius, press the button for 2 seconds will change back to Fahrenheit.

4. STEAM TEMPERATURE AND TIME SETTING



When the steam generator is turned on, press the button  to set the room temperature, the °F flashes. Press  or  will change room temperature between 50 - 130 °F (10 - 55°C). Keep pressing  or  to change the room temperature setting rapidly.

Press  to set steam time. Pressing  or  will change steam time between 1-60 minutes. Keep pressing  or  to change the steam time setting rapidly.

5. USER PREFER MODE

When the Control Panel is activated, press  to select customized setting between U1, U2 and U3 for the system. After customized setting is selected, any setting change will be saved automatically. If there isn't any setting in 5 seconds, setting will be canceled and the screen will show the room temperature again.

6. LIGHTS

When the Control Panel is activated, press  to turn on the Light. The indicator above  is on. Press  again to turn off the light.

NOTICE:

1. To save the batteries of Control Panel, the screen of it will be up for 2 seconds with 1 minute intermittent to show the room temperature. When the Control Panel is activated, it will be off if there isn't any operations in 10 seconds.
2. Control Panel should stay with its bracket. If the Control Panel is removed from the bracket for 12 minutes, the system will be shut-down.
3. Once the timer is finished, or the generator is manually turned off, and stays off for 2 hours, the auto drain function will automatically begin draining. Auto drain function will last for 5 minutes.
4. When the batteries are used up, the screen of Control Panel will show .
5. If the wireless Control Panel can't connect to the receiver in 5 minutes, it will shut down automatically.

APP MANUAL FOR STEAM GENERATOR (Only available for GS08TA/WTPFFMK)

Notice: Please note that you will need a 2.4G wireless router.

1.DOWNLOAD APP ON SMART PHONE

- A. For Android phone,
Scan QR to install APP.
- B. For IOS Phone(Iphone)
Search “**Smart Life**” in APP STORE directly to download APP



Android QR Code

- C. Enter download interface as show on pictures, click“**download**”, choose“**Installation**”to install the app.

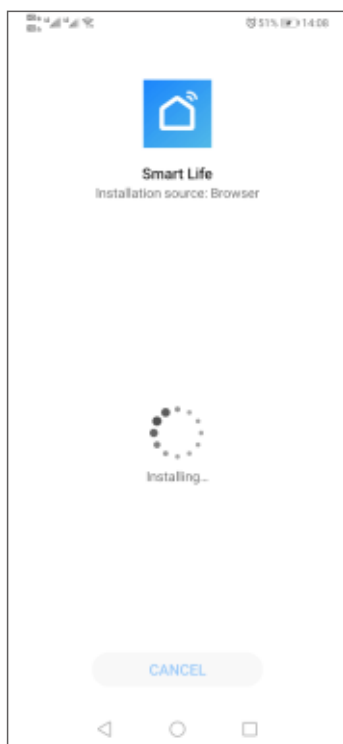
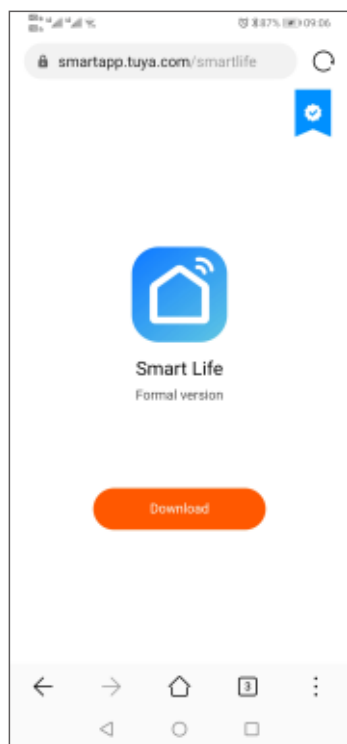

2.USER REGISTRATION AND SIGN IN

Click APP logo“Smart Life” to enter into login interface as picture shown. Register a new account for the first time use.

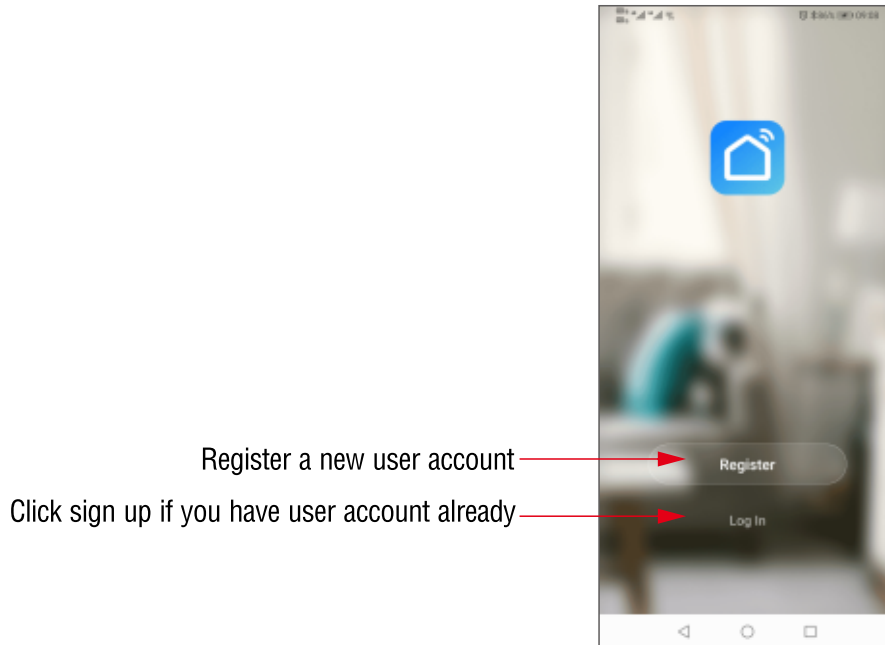

3. Adding your steam generator to the APP List

After logo in, please add your steam generator by following steps below.

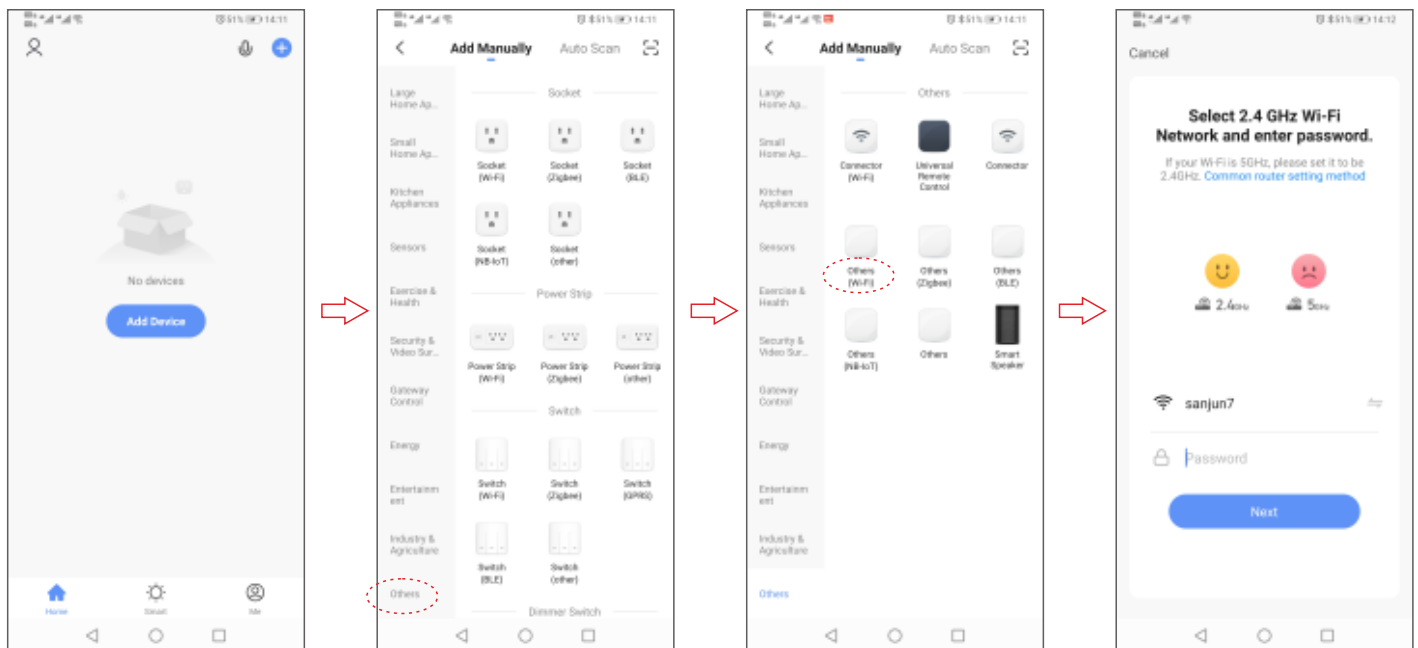

1. Click“Add Device”

2. Click again“others”.

3. Choose “others (Wi-Fi)”.

4. Input WIFI password and click“Next”.

5.1 WIFI CONNECTION FOR GS08TA

Press **>** on the right of **WIFI match**. A small window jumps out. Press **"YES"** to start WIFI matching between the Control Panel and the mobile phone. Press **"NO"** will stop (Figure A)

Notice: If pairing is unsuccessful in 2 minutes, system will stop the pairing state automatically. Select " No " to give up the pairing operation.

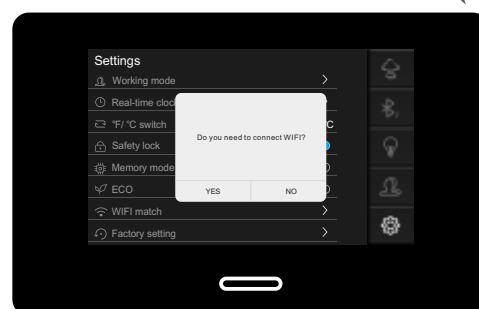
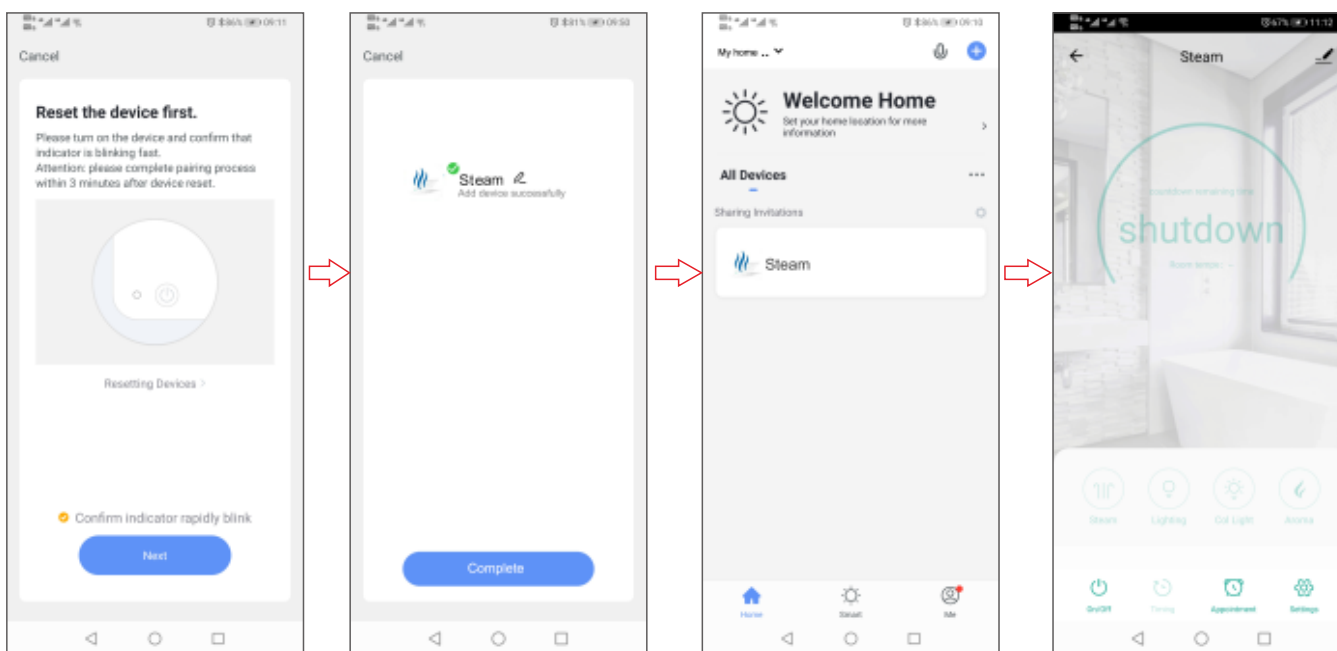

Figure A

5.2 WIFI CONNECTION FOR WTPFFMK

Press any key to activate the Control Panel, then press **⊕** for 2 seconds immediately. The screen shows " *NE* " to indicates the Control Panel is in WIFI matching state.

6. When steam generator is in matching state, click "Next" to add steam generator in APP and enter into product Operation interface :



- Click "Next" to enter directly.
- Change device name as you wish. After steam generator added in the list. Click "Completed".
- Select the "Steam" to enter the operation interface.
- Click "On/Off" to turn on or off the steam system.

4. OPERATION INTERFACE OF STEAM GENERATOR



5.FUNCTION

A. Steam temperature Setting

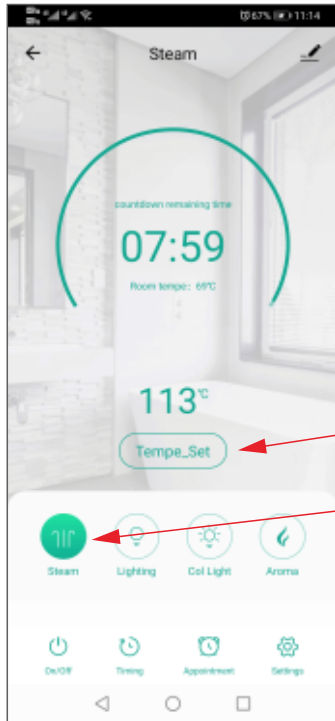

Scroll up or down to set steam TEMP and click "confirm"



Steam function on, Click "Tempe_Set"

Click steam button

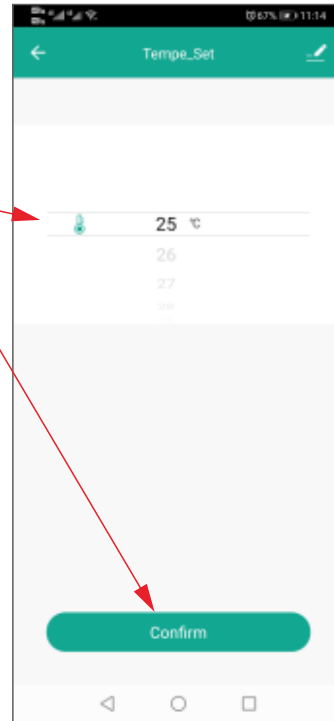

B. Working Time Setting

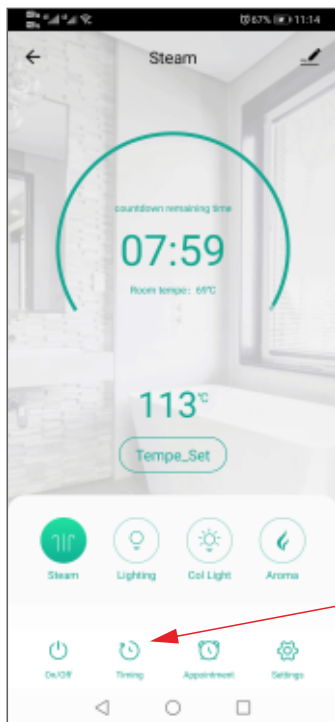

Scroll up or down to set steam TEMP and click "confirm"



Steam function on, click "Timing" to enter timing setting interface



C. Appointment Setting

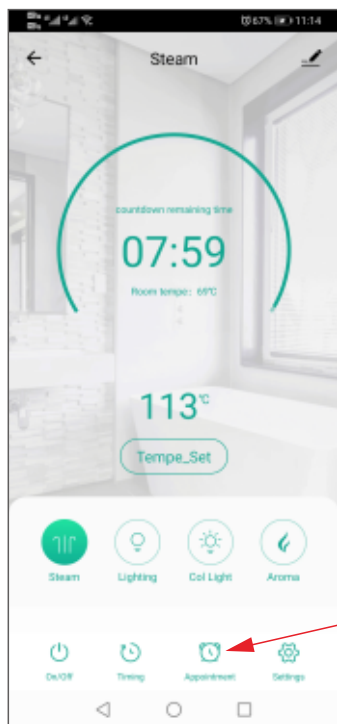

Scroll up or down to set steam working time.

Click Monday to Sunday to set working mode

Click "Confirm" to sure setting and quit the interface

Click "Appointment"

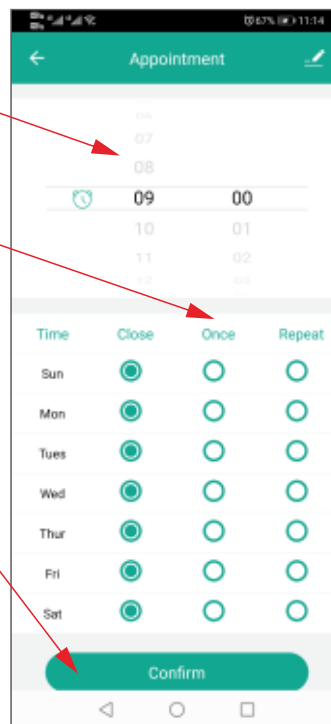

D. Chroma Light

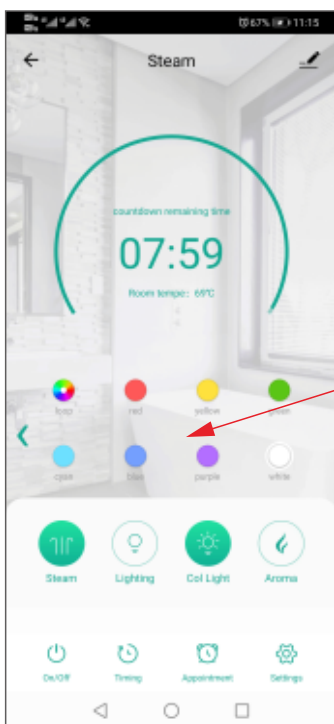

Turn on the steam and chroma light at same time, Select the color of the lights by pressing the icons. The color of the lights change immediately.

E. Light and Aroma Light

Steam function on, click the "light" button to switch on/off the light.

When steam function on, click aroma light button to switch on/off the aroma light.

F. Setting

1. Auto. clean function

Not available. DO NOT SWITCH THIS FUNCTION ON.

2. Temperature unit switch

Click temperature scale switch, the temperature unit can be switched between Celsius and Fahrenheit.

3. Real-time Clock

Click the real time clock to get real clock time is same as the clock shows on control panel.

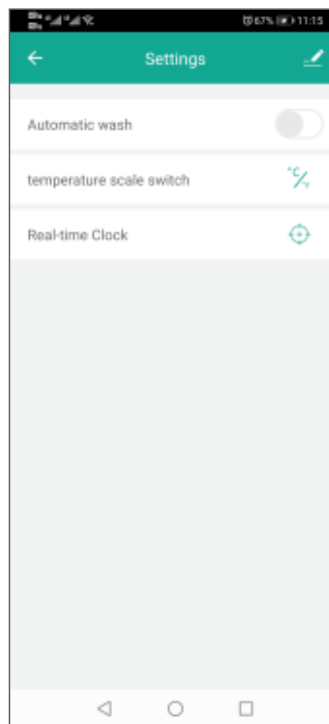

G. Parameter Settings

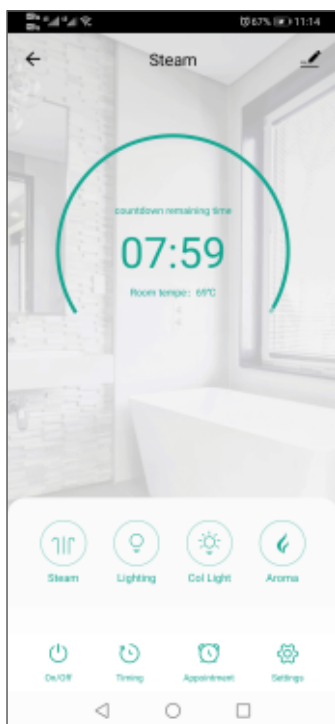

Click here to set more function.

Device name Settings.

Share devices with others.

Click to remove device.

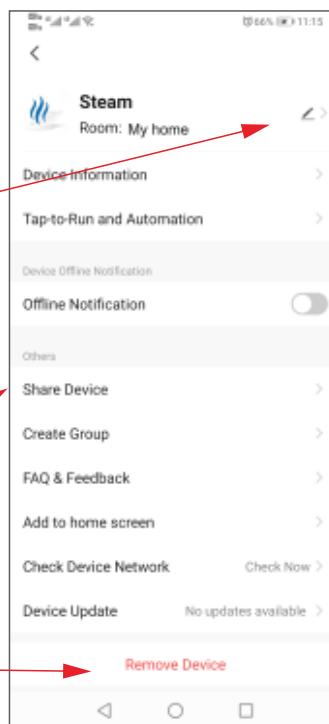

H. Share device and remove device

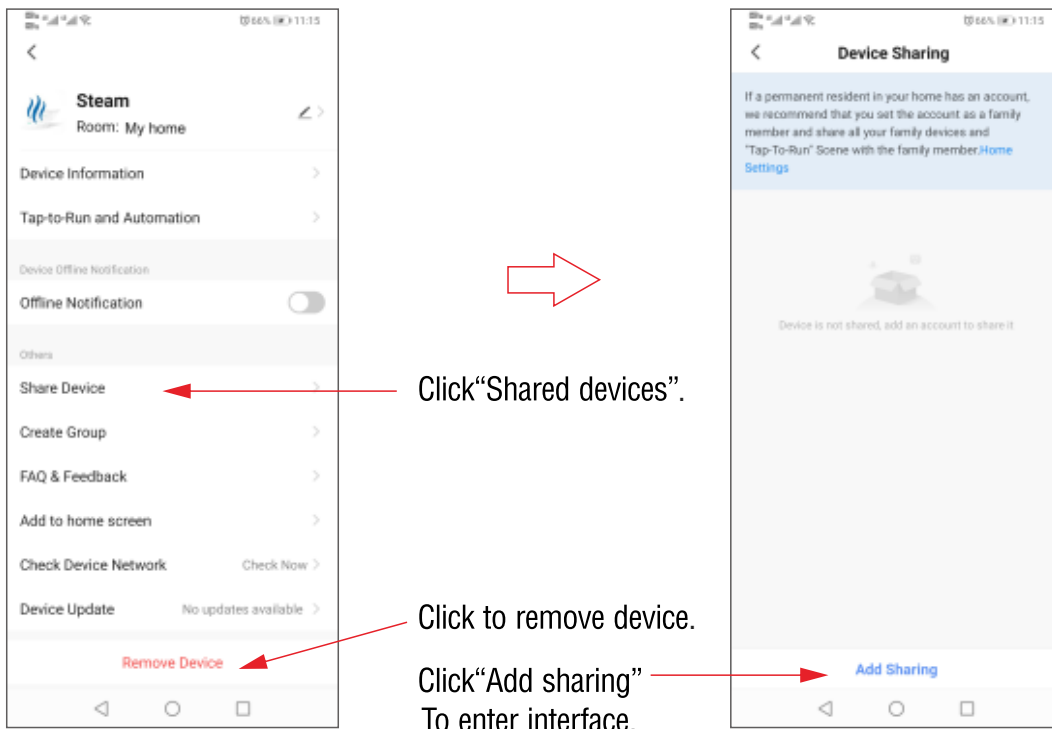

Enter the user account who you would like to share the device with. But this user account should be registered on "smart life" APP.

After input the user account, click "Done" to finish.

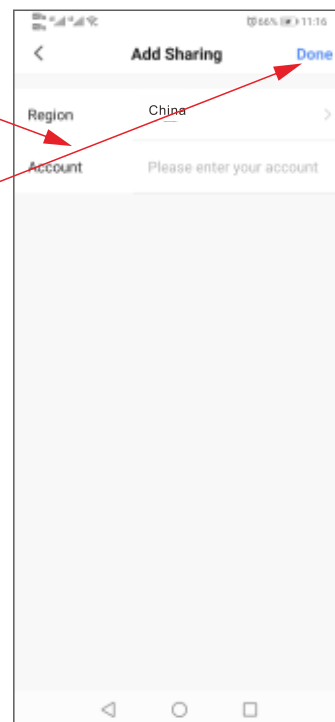

STEAM GENERATOR MAINTENANCE

IMPORTANT! The steam generator automatically performs a water discharge operation after each use.

1. Wait for the completion of automatic water discharge after each time using the steam generator to make sure the water in the tank is discharged completely before cutting off power supply.
2. There should not be any leakage or damage among the steam generator, steam nozzle, components and pipes. They should be checked and repaired annually.
3. Clean the water supply pipes of the steam generator once a year.
4. Check all the pipe connections, to ensure whether they are water tight and intact after being used.
5. It is recommended that the water sensor prong gets clean once every six month.
 - a. Remove the cover of the generator.
 - b. Locate the water sensor.
 - c. Label each electrical connections then carefully remove all connections.
 - d. With a wrench or a 32mm ratchet socket carefully unscrew the water sensor.
 - e. Thoroughly clean any residue build-up accumulated on the prong.

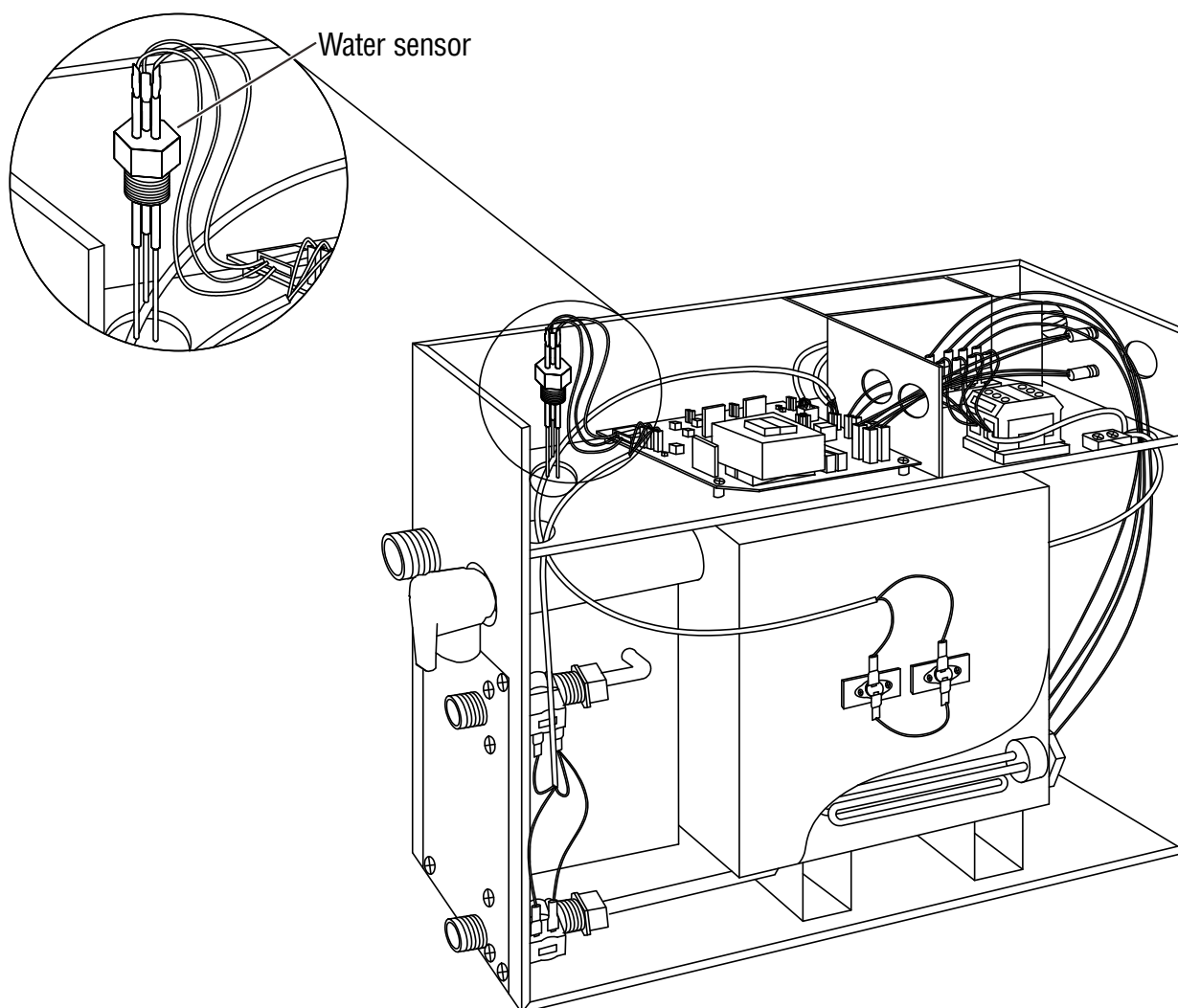



TROUBLE SHOOTING GENERATOR

- Generator Maintenance and Service should be completed by Licensed Plumber or Electrician.
- Turn Off Electrical Breaker and Water Supply Before Any Work On Electrical Connection is attempted.

PROBLEM	POSSIBLE CAUSES	SOLUTIONS
The machine does not start when powered	<ol style="list-style-type: none"> 1. Fuse blown. 2. The electrical wiring is loosened 3. Control panel connection is loosened 	<ol style="list-style-type: none"> 1. Replace fuse (0.8A/240V) 2. Cut power Supply and reconnect wiring 3. Reconnect control panel and restart it
Breakers are tripped	<ol style="list-style-type: none"> 1. Check gauge size 2. Damaged heating element 	<ol style="list-style-type: none"> 1. Replace wire with correct gauge 2. Replace heating element
When the machine is started, hot water comes out with little or no steam	<ol style="list-style-type: none"> 1. Check inlet valve 2. Check cable pins 	<ol style="list-style-type: none"> 1. Clean or replace valve 2. Clean or replace pins
The display screen on the control panel does not display anything	<ol style="list-style-type: none"> 1. The control panel wire is not connected properly 2. Motherboard failure 	<ol style="list-style-type: none"> 1. Check whether the connection plug between the control panel and the generator is loosened, and whether the power supply is in good contact 2. Replace the motherboard
Water leakage	<ol style="list-style-type: none"> 1. The water pipe connector is loosened or pipe is broken. 2. Water leakage in the water input valve or the water drainage valve 	<ol style="list-style-type: none"> 1. Tighten the loosened connection or replace the broken pipe 2. Replace the water input valve or the water drainage valve
No steam when starting the machine	<ol style="list-style-type: none"> 1. No power 2. No water 3. The set temperature is too low 4. Wiring connection problem 	<ol style="list-style-type: none"> 1. Check the power supply and connections 2. Check the water input pipe and water input valve 3. Reset the temperature 4. Check wiring connection and tighten
The steam does not come out, the water sounds in the machine	<ol style="list-style-type: none"> 1. Something wrong with the heating element. 	<ol style="list-style-type: none"> 1. Clean or replace heating elements
Light doesn't turn on	<ol style="list-style-type: none"> 1. Failure LED light bulb 2. Wiring connection improperly connected or light cable damage 	<ol style="list-style-type: none"> 1. Change LED light bulb 2. Tighten connection or replace light cable
Cold water is coming from the steam head	<ol style="list-style-type: none"> 1. The water sensor cable is loose or water level sensor is defected 2. Check cable pins 3. Check inlet water valve 	<ol style="list-style-type: none"> 1. Make sure that the water level cable isn't loosened. If the cable is well connected, then replace the water sensor 2. Replace cables 3. Clean or replace inlet valve
05 Error Code	<ol style="list-style-type: none"> 1. Water inlet problem 	<ol style="list-style-type: none"> 1. Check water supply 2. Check inlet valve for blockage. It may need cleaning or replacement.

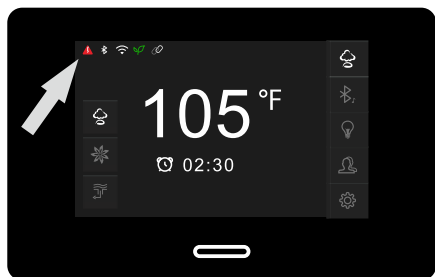
TROUBLE SHOOTING- GS08TA



When  appears on screen, it means a malfunction has been detected. Press  to display the possible cause and solution.

 Water inlet tank for 2 minutes, but still not reaching the desired water level.

Please check if there is a water supply and if the water inlet valve is functioning properly.

Water inlet failure

 Overheat Protection Triggered Due to Abnormally High Temperature

Please check if there is any evidence of dry burning.

Overheat protection

 Temperature Sensor Short Circuit

Please check the temperature sensor cable. If it is damaged, replace the temperature sensor.

Short Circuit Issue with Temperature Sensor

 Steam Generator and Control Panel Communication Failure

1. Check if the cable connections are secure.
2. Verify if the IP addresses match.

Communication problem

 Temperature Sensor Open Circuit

Please check the temperature sensor cable. If it is not functioning properly, replace the temperature sensor.

Open Circuit Issue with Temperature Sensor

 Signal Transfer Problem Between Main Control Panel and Secondary Control

1. Check if the cable connections are secure.
2. Verify if the IP addresses match.

Signal Transfer Failure Between Main Control Panel and Secondary Control

TROUBLE SHOOTING- WTPFFMK/WTPMK

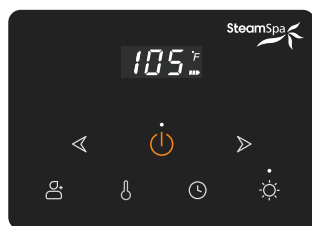

WTPMK

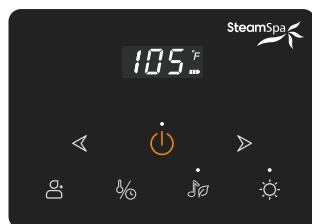

WTPFFMK

ERROR CODE	POSSIBLE CAUSES	SOLUTIONS
E1	Connection issue between the receiver and steam generator or receiver and Bluetooth box (no signal in 15seconds)	Ensure that the wire connections between the receiver and steam generator, or between the Bluetooth box and steam generator are secure. If a pin inside the connector is bent, replace the cable.
E2	Communication failure between the control panel and the receiver box.	<ol style="list-style-type: none"> 1. Ensure the distance between the control panel and the receiver is less than 98 ft (30 meters). Walls may reduce the communication distance. Try relocating the receiver box closer to the control panel. 2. Ensure that the wire connections between the receiver and steam generator are secure. 3. Make sure the receiver box is powered on. 4. Check whether the control panel is successfully paired with the receiver box. 5. Contact SteamSpa.
E3	Excessive Heat warning is triggered due to high temperature of the tank	<ol style="list-style-type: none"> 1. Make sure the pipe size is sufficient for the steam outlet. 2. Maintain the elbows for steam outlet are no more than two. 3. Check the heating elements for scale build-up. Clean the heating elements if needed.
E4	The tank doesn't fill up within 1 minutes.	<ol style="list-style-type: none"> 1. Turn off the shut-off valve and disconnect the hose from the steam generator. Turn on the shut-off valve again and make sure there is sufficient flow rate.
E5	The tank doesn't fill up within 2 minutes.	<ol style="list-style-type: none"> 2. Check the water inlet valve for blockage. 3. Contact SteamSpa.
E6	Water drainage failed.	<ol style="list-style-type: none"> 1. Check the drain-pipe for blockage. 2. Check the water inlet valve for blockage. 3. Contact SteamSpa.
E8	Temperature sensor failed.	<ol style="list-style-type: none"> 1. Check the wire connection to the temperature sensor. 2. Replace the temperature sensor if necessary.

STEAM SPA TROUBLE SHOOTING

Generator Maintenance and Service should be completed by Licensed Plumber or Electrician

Turn Off Electrical Breaker and Water Supply Before Any Work On Electrical Connection is attempted

UNIT LEAKING WATER OUT OF THE STEAM OUTLET:

- **PSI TO UNIT GREATER THAN 15-20PSI:** Confirm that the PSI going to the unit is regulated between 15-20 PSI (Most House Lines Run Off approx. 50-100, (a Pressure Regulating Valve may be required).
- **WATER SENSOR IS DEFECTIVE:** (New Generator/Elements): Remove heating elements and check for corrosion/burn out of element.

MY CONTROL IS NOT TURNING ON:

Turn Off Breaker Before Any Work On Electrical Connection is attempted

- **BREAKER IS NOT TURNED ON:** Have the customer check if the breaker has been turned on for the unit.
- **LOOSE CONTROL PANEL CABLE CONNECTION:** Check to see if arrow on the connection are lined up and plugged into each other completely.
- **WIRE GAUGE FOR ELECTRICAL CONNECTION INCORRECT:** Check the gauge of wire installed, and compare to the "Ampere Meter" chart on pg. 9 of the manual, to ensure correct gauge wire is being used.
- **AMPERAGE NOT SUFFICIENT:** Check breaker size against the "Ampere Meter" chart on pg. 9 of the manual. If breaker is not sufficient, the breaker will need to be changed.
- **VOLTAGE NOT SUFFICIENT:** Ensure that the generator is connected 240v electrical supply.
- **DAMAGED 1FT. CONTROL CABLE:** Have customer check the pins at the male connection coming from the back of the generator. If pins look to be okay, remove lid to see if connection made at terminal block is loosened. If so press connection in completely.
- **DAMAGED CONTROLLER EXTENSION CABLE:** Look at the male and female end of the 20ft extension. Check if there is visible damage to the pins and connection, or if any pins are missing from the male end of the cable.
- **LOOSE CONNECTION AT TERMINAL BLOCK:** Make sure all connection made at the terminal block are inserted and tightened securely.
- **BROKEN FUSE HOLDER:** Unscrew top panel and look at fuse connections. If any damage seen to the fuse holder or connection.
- **FUSE HAS BURNT OUT:** Unscrew fuses (2 black rubber screws located on the exterior of the generator in-between the electrical connection and control panel connection cable). Look to see if fuse wire is broken or dark residue inside of fuse.
- **MOTHERBOARD MALFUNCTION:** Please contact Technical Support to request a new Motherboard.

CONTROL PANEL READING 02 (CONTROL CONNECTION) ERROR:

- **CONTROL CABLE CONNECTION LOOSE:** Confirm that control cable connections are tightly made by pressing together firmly.
- **CONTROL CABLE PINS BROKEN:** Confirm that the cable connections are intact and no pins are missing from the generator to extension connection or the extension to control panel extension.
- **LOOSE SHORT CONTROL CABLE:** Remove the top of the unit. Then look to see where the large grey wire runs to the mother board. Press down on white connection and snap into place.
- **DAMAGE TO CONTROL PANEL CONNECTIONS:** Inspect the grey cable that runs from the motherboard to the control panel. Check Generator Cable, Extension Cable, and the grey Control Panel Cable for kinks in the line where wiring could have broken.
- **LOOSE RELAY CONNECTION:** Check to see if all connections are completely secured on the motherboard and connection points. If any are loose, secure connection.

STEAM SPA TROUBLE SHOOTING

CONTROL PANEL READING 05 (WATER LEVEL) ERROR:

- **WATER PRESSURE NOT SET CORRECTLY:** Confirm that the PSI going to the unit is regulated between 15-20 PSI (Most Homes can have approx. 50-100psi).
- **FLOW TO UNIT NOT REDUCED:** Reduce flow of water by closing shut-off valve on water intake line to 20% open and 80% closed.
- **WATER LEVEL SENSOR CONNECTION IS LOOSE:** Remove top panel of generator and check to see if there are loose connections on the water level sensor by removing rubber cover. If so snap into place and replace rubber cover.
- **WATER LEVEL SENSOR HAS SEDIMENT OR CALCIUM BUILDUP:** Remove Water level Sensor and check for corrosion/buildup. If there is build-up on the sensor prongs, soak for approx. 15-20 min in vinegar then wipe off the residue buildup. If the sensor is corroded, contact Technical Support to request a new Water Level Sensor.
- **SEDIMENT STUCK IN LINE:** Remove threaded line to water intake connection. Check inside of the inlet connection for sediments. If sediment found look into adding or replacing the filter and removing sediment from the inside of the connection. (Water inlet valve may need to be removed from generator for service)

GENERATOR TRIPS BREAKER:

- **INSUFFICIENT VOLTAGE:** Confirm that Voltage to the unit is 208v/220v/240v.
- **INSUFFICIENT AMPERAGE:** Confirm that Amperage to the unit sufficient (max output + 20%)
- **IMPROPER GAUGE WIRE:** Confirm gauge of wire for the electrical connection to the unit. If it is larger than the required size decrease until you are at the recommended gauge or lower. For the correct gauge size See Electrical requirements chart (page 9)

CONTROL PANEL ON WITH NO FUNCTION:

- **CONTROL CABLE PINS BROKEN:** Confirm that the cable connections are intact and no pins are missing or broken from the generator to extension connection or the extension to control panel extension.
- **CONTROL CABLE CONNECTION IS LOOSE:** Confirm that control cable connections are tightly made by pressing together firmly at xyz connections.
- **LOOSE RELAY CONNECTION:** Check to see if all connections are completely secured on the motherboard and connection points. If any are loose, secure connection.
- **DEFECTIVE MOTHERBOARD:** Faulty motherboard. Faulty motherboard; please contact Technical Support to request new Motherboard.

DECREASED STEAM PRODUCTION/ NO STEAM PRODUCTION :

- **HEATING ELEMENTS ARE CORRODED/DAMAGED:** Remove top, side, and small back access panels. Disconnect leads from the heating elements and remove the elements from the generator, and inspect the elements for corrosion or damage.
- **HEATING ELEMENTS HAVE CALCIUM OR SEDIMENT BUILDUP:** Remove top, side, and small back access panels. Disconnect leads from the heating elements and remove the elements from the generator, and inspect for build-up. Soak for approx. 15-20 min in vinegar then wipe off the residue buildup. (Buildup on elements a sign that the filter may need to be changed or added)
- **FILTRATION TO THE UNIT HAS NOT BEEN CHANGED:** Customer has not changed the filter to their unit in the recommended time frame (provided within our warranty policy). Remember that heating elements do vary depending on the wattage of the unit.
- **LOOSE WIRE CONNECTION TO HEATING ELEMENT:** Remove the panel underneath the electrical connection and the control panel power cable. Look to see that connection made at element are both properly and securely made.

TECHNICAL PARAMETERS

Type	4.5KW	6KW	7.5KW	9KW	10.5KW	12KW
Power (KW)	4.5	6	7.5	9	10.5	12
Voltage (V)	240	240	240	240	240	240
Current (A)	19	25	32	38	44	50
Errors Range	+10%	+10%	+10%	+10%	+10%	+10%
Anti-Static Constant	>1500V	>1500V	>1500V	>1500V	>1500V	>1500V
Insulation Resistance	>20M Ω	>20M Ω	>20M Ω	>20M Ω	>20M Ω	>20M Ω
Head Lamp	~12V/3W	~12V/3W	~12V/3W	~12V/3W	~12V/3W	~12V/3W
Time Set Range (min)	1-60	1-60	1-60	1-60	1-60	1-60
Steam Press (psi)	3	4	4	4	5	5
Steam Vol. (cu. in./min)	9	11	13	16	19	21
Steam Spray Time (sec)	100-180	180-240	150-210	120-180	170-230	150-160
Water Vol. (cu. in.)	80	160	160	160	330	330

IMPORTANT! The list above is for reference only. Actual checking and repairing should be based on national and local codes, ask professional service personnel to operate.

IMPORTANT! The parameter listed above will vary by geographical location and environment. Please consult a qualified designer and architect for more detailed use.

WIRING CONNECTION (ONE STEAM GENERATOR WITH GS08TA)

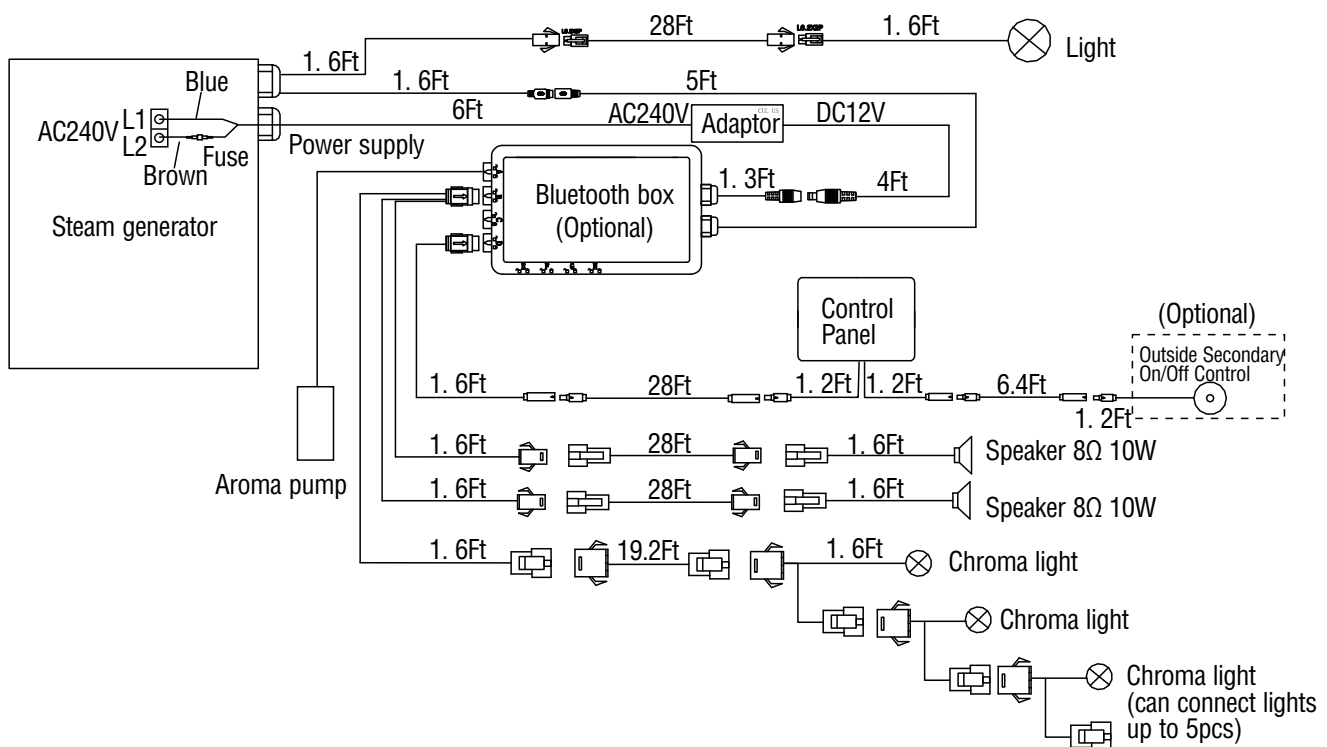

WIRING CONNECTION (TWO STEAM GENERATORS WITH GS08TA)

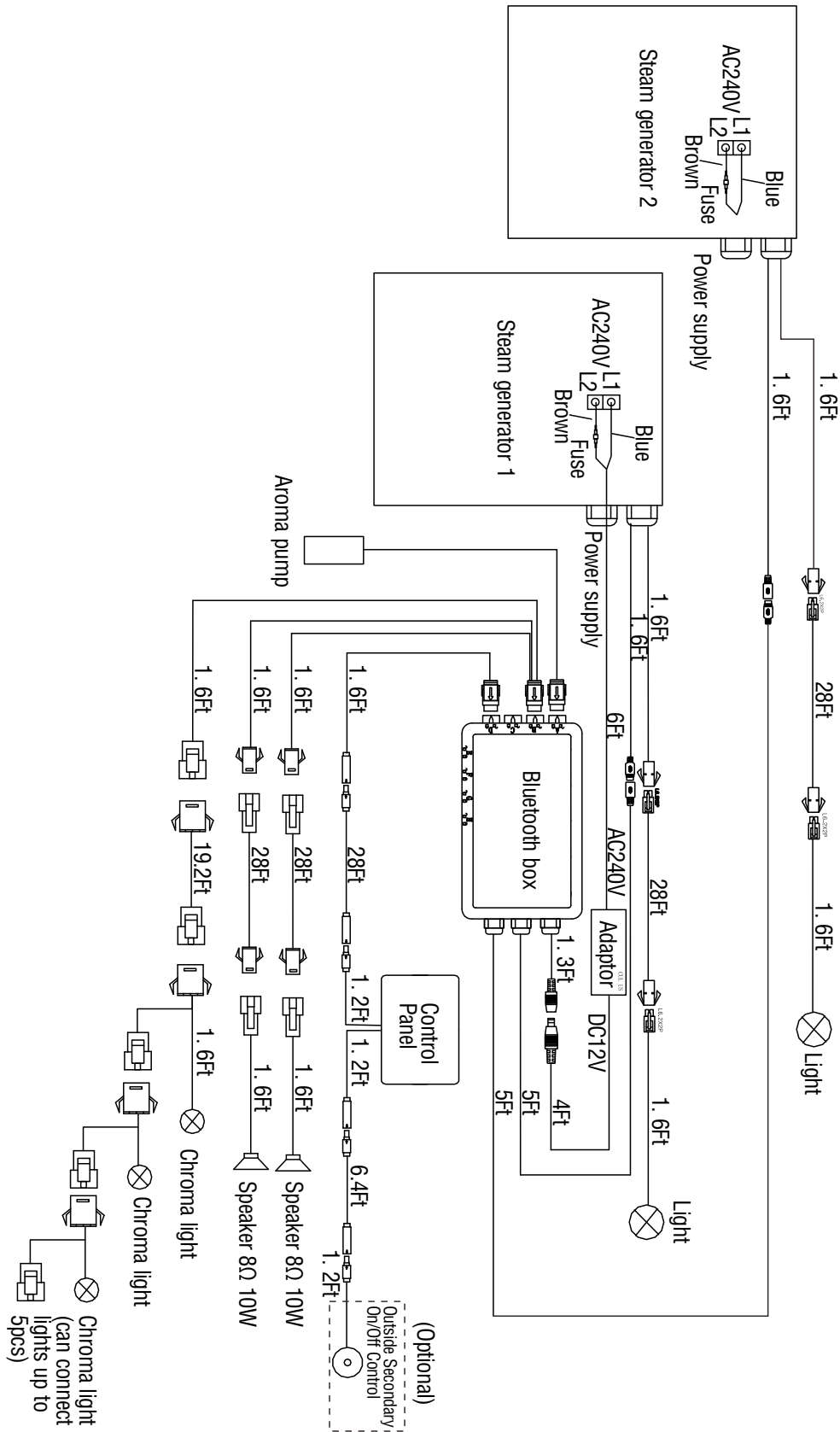

WIRING CONNECTION (ONE STEAM GENERATOR WITH WTPFFMK)

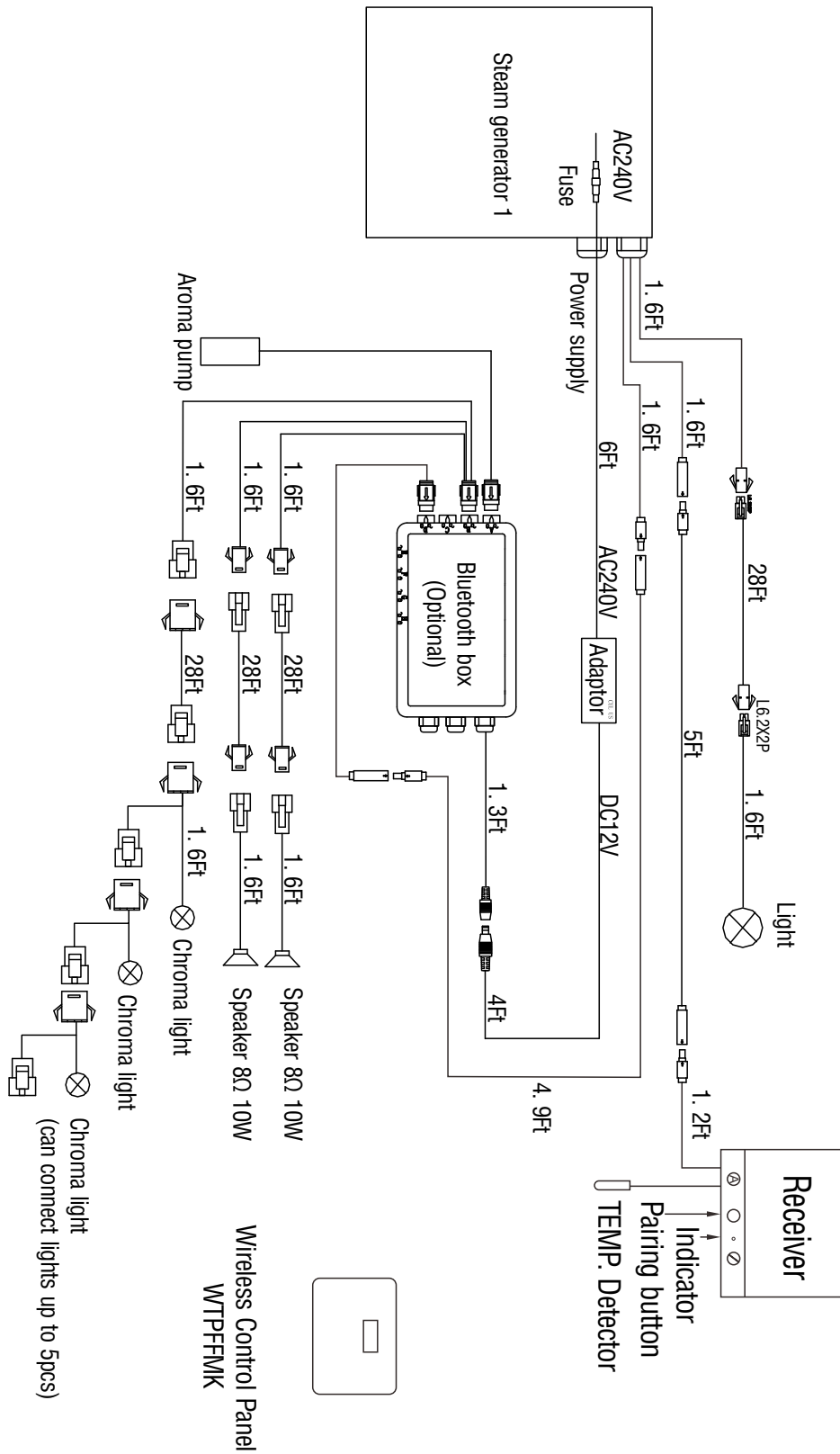

WIRING CONNECTION (TWO STEAM GENERATORS WITH WTPFFMK)

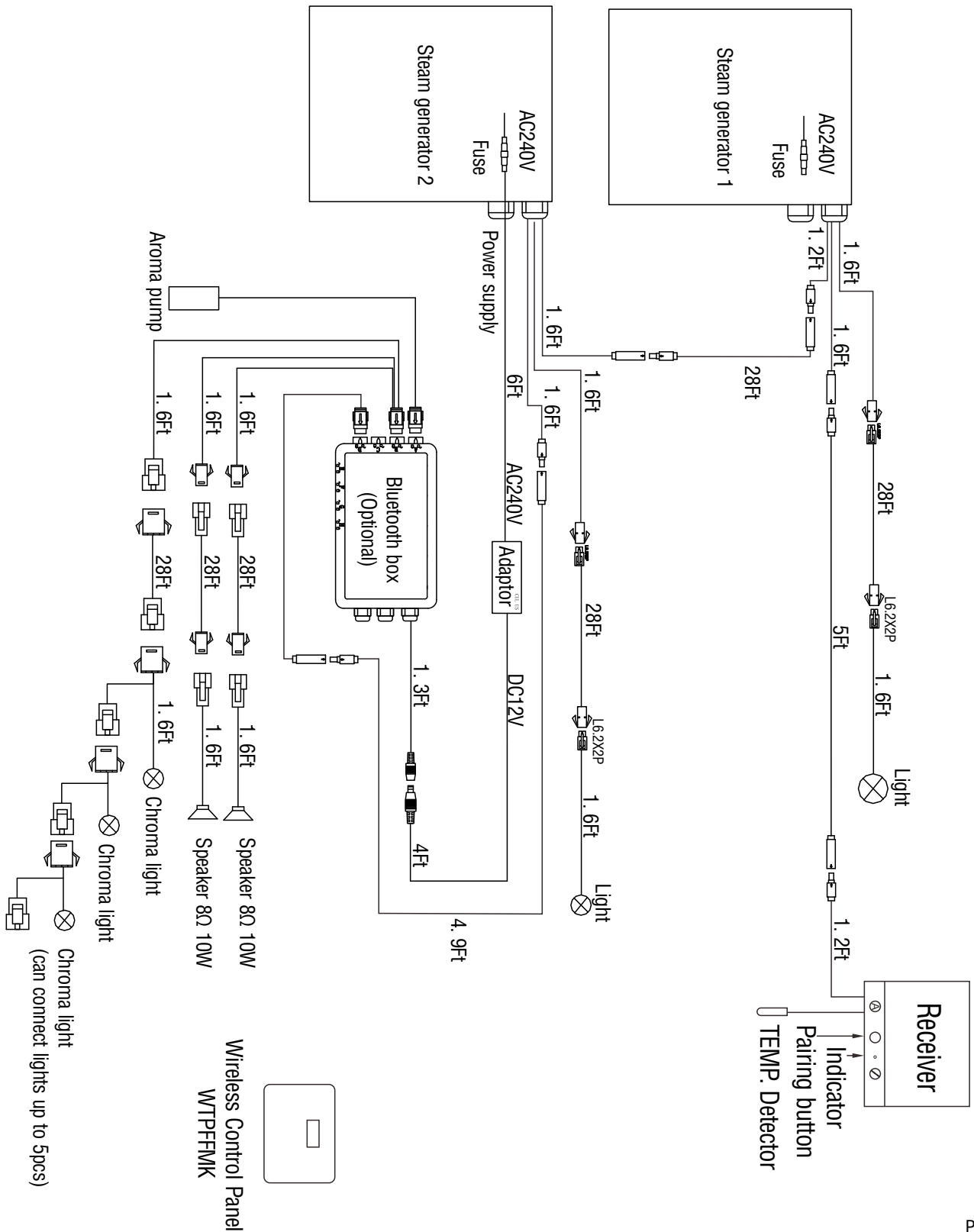

WIRING CONNECTION (ONE STEAM GENERATOR WITH WTPMK)

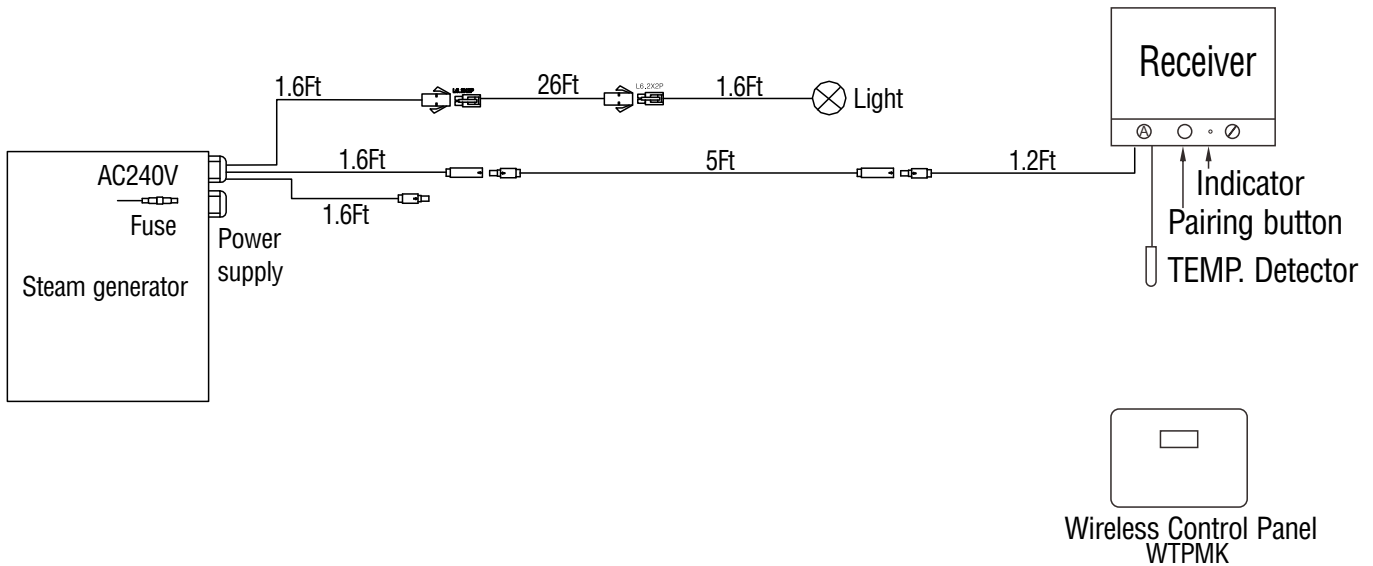

WIRING CONNECTION (TWO STEAM GENERATORS WITH WTPMK)

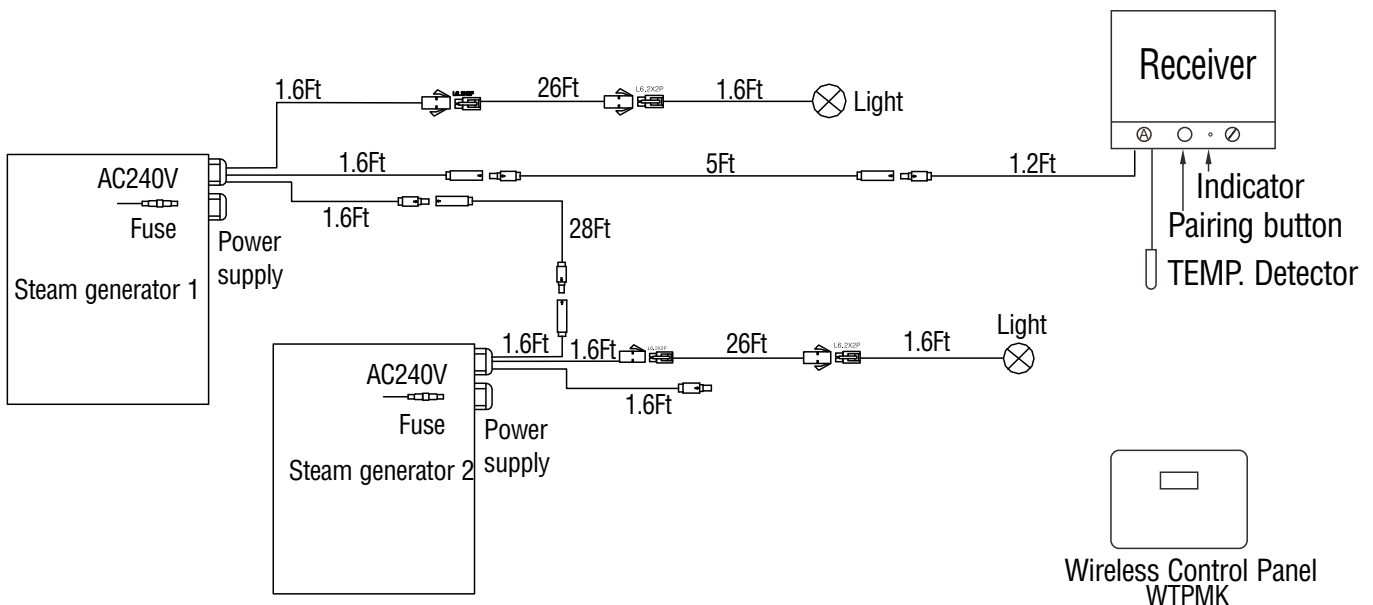

SIZING CHART OF STEAM GENERATOR

*Cabin Dimensions	Cubic Feet	Generator
3x3x7	63	4kw or 6kw
3x4x7	84	7kw or 9kw
3x5x7	105	9kw or 10.5kw
3x6x7	126	9kw or 10.5kw
3x7x7	147	10.5kw or 12kw
3x8x7	168	12kw
4x4x7	112	9kw
4x5x7	140	9kw or 10.5kw
4x6x7	168	10.5kw or 12kw
4x7x7	196	12kw
4x8x7	224	12kw
4x9x7	252	12kw
5x5x7	175	12kw
5x6x7	210	12kw
5x7x7	245	12kw
5x8x7	280	12kw
5x9x7	315	12kw

SIZING CHART OF DUAL STEAM GENERATORS



*Cabin Dimensions	Cubic Feet	Generator
6x8x7	265-370	15kw(total)
6x10x7	350-460	18kw(total)
7x10x7	380-530	21kw(total)
8x10x7	440-600	24kw(total)

***Cabin dimensions are based on WxLxH**

NOTE: It's safe and even recommended to use a generator size, 1-step higher than what the chart indicates.

CONTROL PANEL PAIRING-WTPFFMK / WTPMK

When the wireless control panel is damaged. It needs to pair the new control panel with the receiver as follows.

1. Remove the plug in the middle of receiver, you'll find a small button inside.
2. Slightly press the small button. The indicator beside should flash fast.
3. Press  on the control panel to activated it. Then press and hold  until the control panel shows **PE**. When the pairing is completed. The screen shows **PA**. The indicator stops flashing fast.
4. If the pairing is fail, the screen will show **PF**.

