













# ASSEMBLY INSTRUCTION

ITEM: #5381 - 90651 Poster Bed Headboard 5/0  
5381 - 90652 Poster Bed Footboard 5/0  
5381 - 90653 Side Rail 5/0-6/6

Thank you for purchasing this quality product. Be sure to unpack carefully looking for small parts which may have come loose during shipment.

Read all instruction and study the drawing carefully before starting the assembly process:

HARDWARE LIST OF HEADBOARD - 91251				
NO.	DESCRIPTION	SIDE	DRAWING	QTY
A	HANGER BOLT	Φ5/16" *3-1/2"		4PCS
B	BOLT	Φ5/16" *1-3/4"		2PCS
C	CURVED WASHER	Φ5/16"		4PCS
D	FLAT WASHER	Φ5/16"* 16MM		6PCS
E	LOCK WASHER	Φ5/16"		6PCS
F	NUT	Φ5/16"		4PCS
G	OPEN WRENCH	Φ5/16"		1PCS

HARDWARE LIST OF BED RAILS - 91263				
NO.	DESCRIPTION	SIDE	DRAWING	QTY
H	HANGER BOLT	Φ5/16"*3-1/4"		8 PCS
I	NUT	Φ5/16"		8 PCS
J	LOCK WASHER	Φ5/16"		8 PCS
K	FLAT WASHER	Φ5/16"*16MM		8 PC
M	CURVED WASHER	Φ5/16"		8 PCS
N	OPEN WRENCH	Φ5/16"		1PC

HARDWARE LIST OF FOOTBOARD - 91252				
NO.	DESCRIPTION	SIDE	DRAWING	QTY
L	SCREW	#8*1"		8 PCS

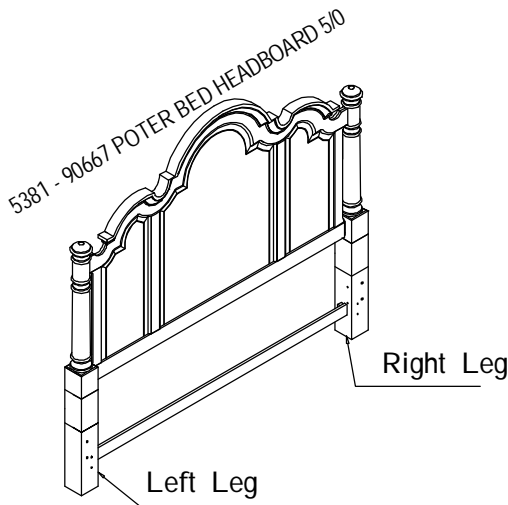

**STEP 1:** Attach legs to headboard using bolts(A), lock washer(E), flat washer(D), and attach bottom rail to the legs using bolt (B) as shown in step 1. Using an open wrench (G) to tighten all the bolts.

## STEP 1

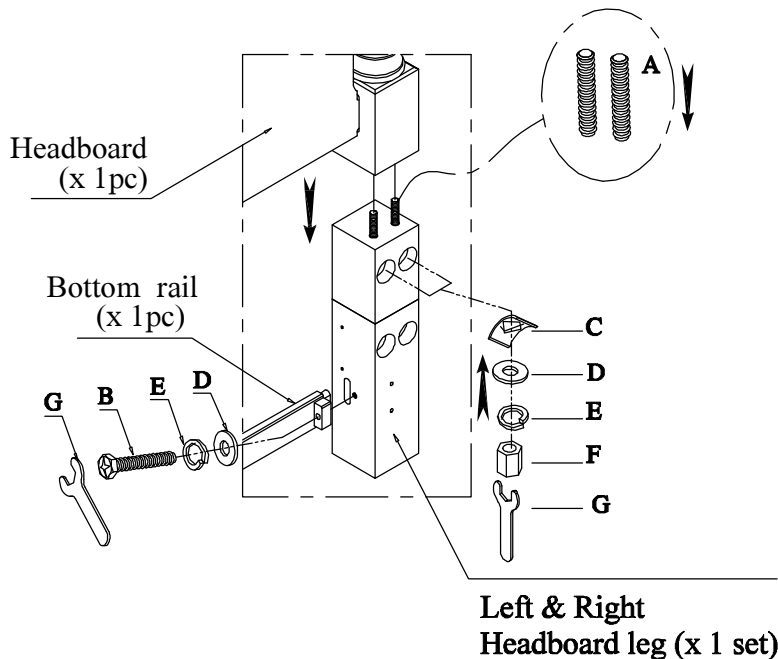

# ASSEMBLY INSTRUCTION

ITEM: #5381 - 90651 Poster Bed Headboard 5/0

5381 - 90652 Poster Bed Footboard 5/0

5381 - 90653 Side Rail 5/0-6/6

Thank you for purchasing this quality product. Be sure to unpack carefully looking for small parts which may have come loose during shipment.

Read all instruction and study the drawing carefully before starting the assembly process:

