





# ASSEMBLY INSTRUCTION

ITEM: 7050-75917-02 Server  
7050-75917-89 Server

Thank you for purchasing this quality product. Be sure to unpack carefully looking for small parts which may have come loose during shipment.  
Read all instruction and study the drawing carefully before starting the assembly process.

HARDWARE PACK

NO.	DRAWING	DESCRIPTION	SIZE	Q'TY
A		Anti - Tip Kit		1 PC

PARTS LIST				
NO.	DRAWING	DESCRIPTION	Q'TY	
1		Fixed Shelf	1 PC	
2		Foot	4 PCS	
3		Center Post	4 PCS	
4		Case Body	1 PC	
5		Center Leg	1 PC	

STEP 4

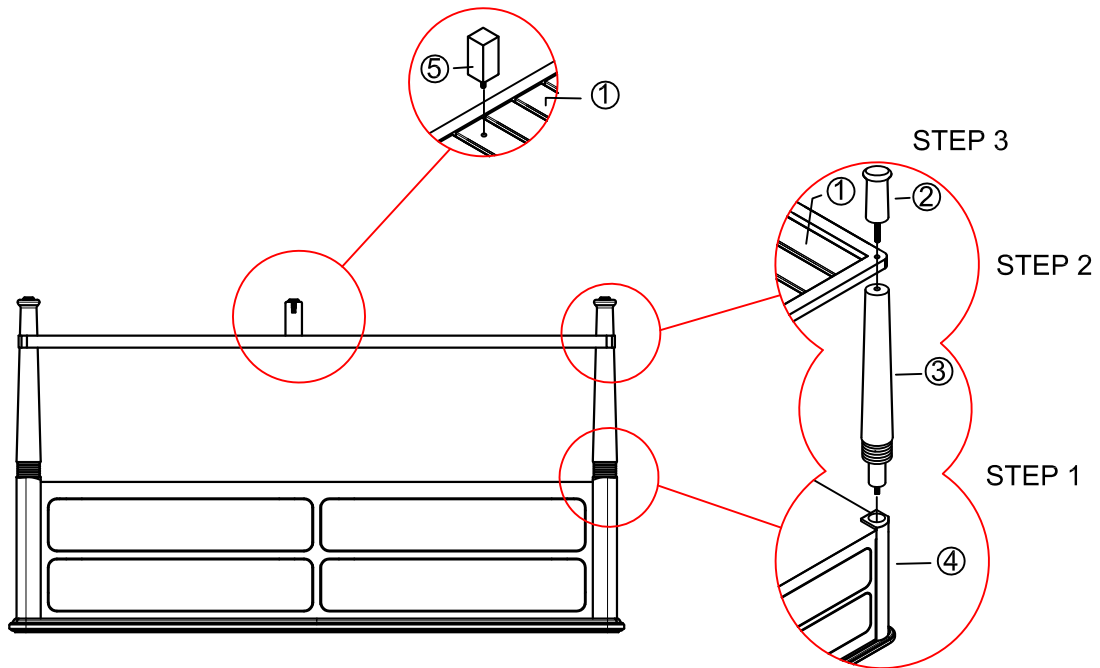

Step 1: Screw center posts (3) into the bottom of the case body (4).

Step 2: Place fixed shelf (1) onto the center posts (3).

Step 3: Well attach the feet (2) through fixed shelf (1) to the center posts (3).

Step 4: Attach center leg (5) to the cleat where it is at the underneath of fixed shelf (1).

Note: Anti-tip kit restraint is provided.  
Please follow the instructions enclosed with the pack.

ITEM: 7050-75917-02 Server  
7050-75917-89 Server

Thank you for purchasing this quality product. Be sure to unpack carefully looking for small parts which may have come loose during shipment.  
Read all instruction and study the drawing carefully before starting the assembly process.

## Tipping Restraint

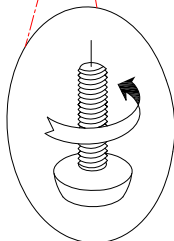
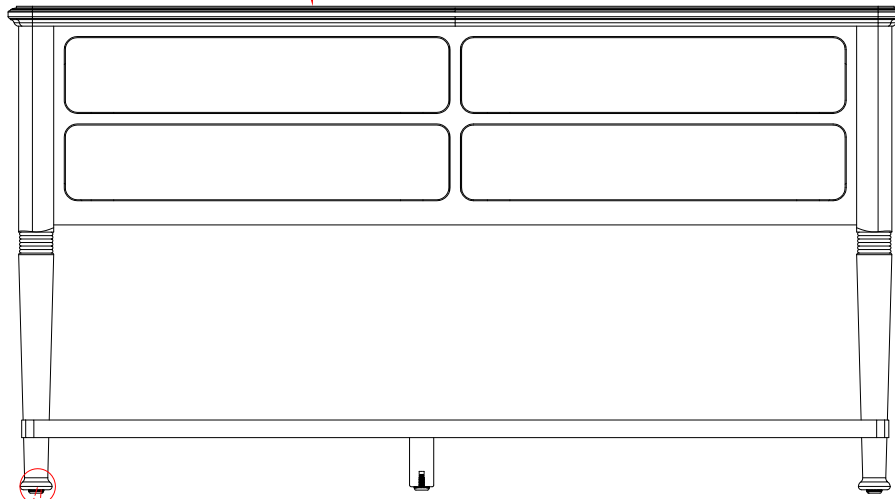
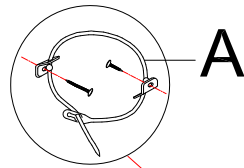

Adjust leveler if needed to level server on uneven floor.