

Bar Bracket 3/4" with Hidden Screws
Polished Chrome

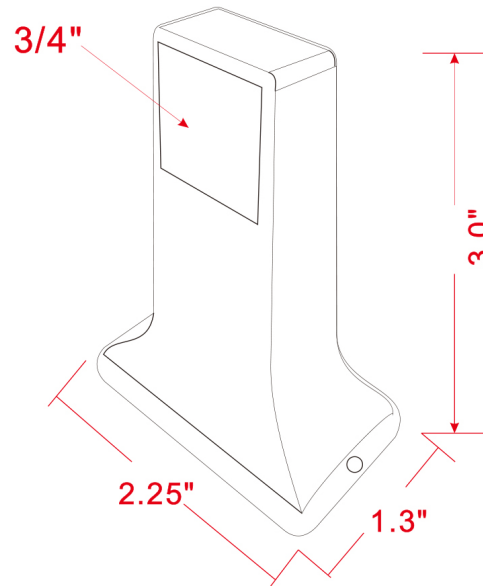

SPECIFICATIONS

MATERIAL CONSTRUCTION:	Zinc
PVD FINISH:	No
ASSEMBLY REQUIRED:	No
TOOLS NEEDED FOR INSTALLATION:	Phillips Screwdriver
ASSEMBLED DIMENSIONS:	2.75" H x 2.25" L x 2" D
ASSEMBLED WEIGHT:	0.32 lbs.
MIN. LENGTH:	N/A
MAX LENGTH:	N/A
SCREWS INCLUDED:	Yes
DRYWALL ANCHORS INCLUDED:	Yes
CENTER TO CENTER:	N/A

WARRANTY:	1-Year limited warranty
LEGAL FOR SALE IN CALIFORNIA:	Yes
ADA COMPLIANT:	N/A



TYPE:
JOB:
ORDER CODE:
APPROVALS: