

VERSANORA

Boomerang L Shaped Desk

**VNF-00114**

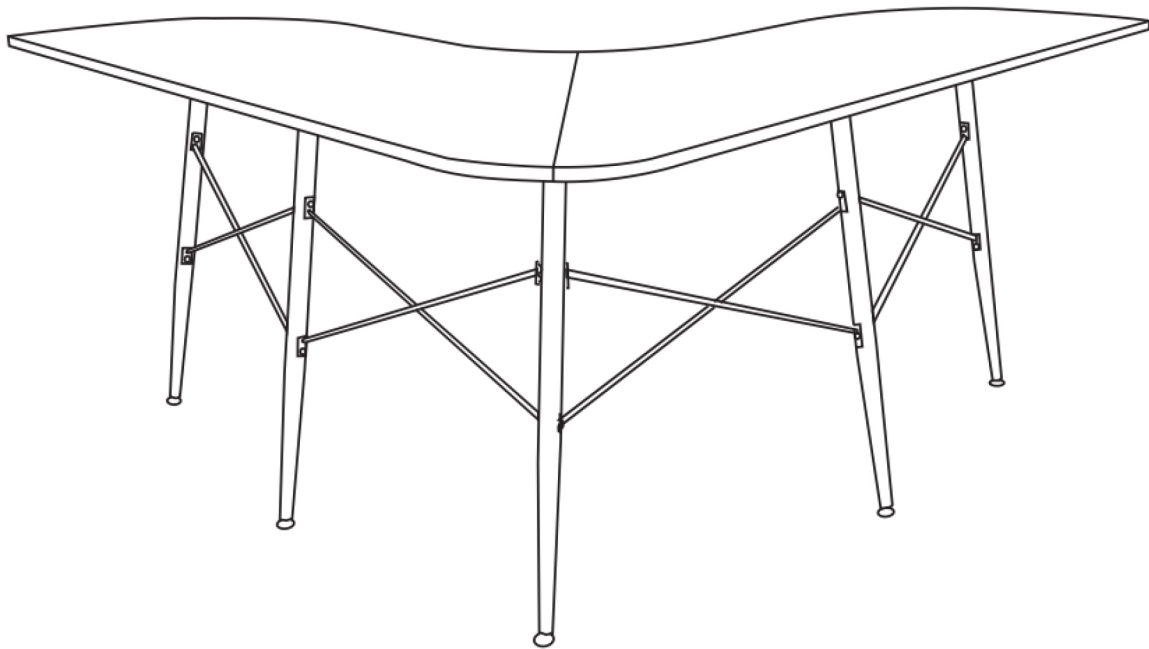

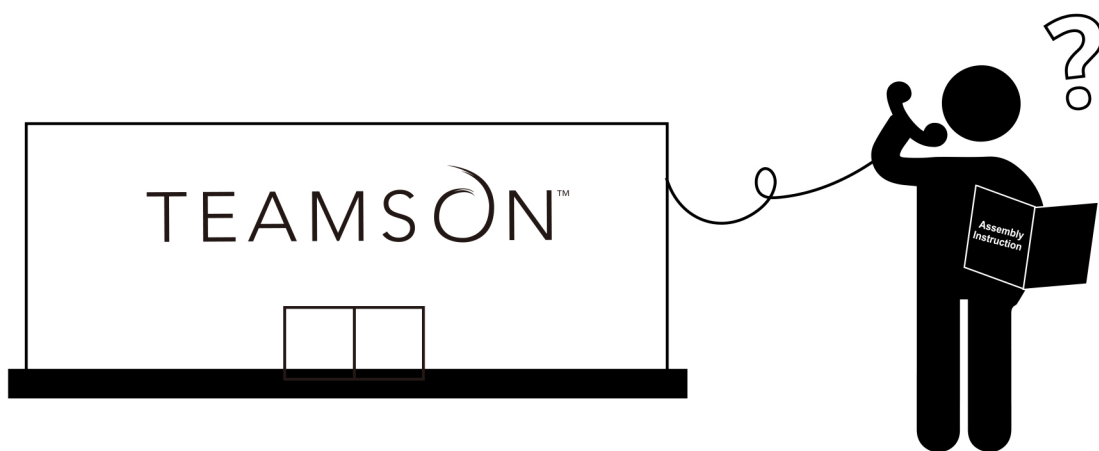
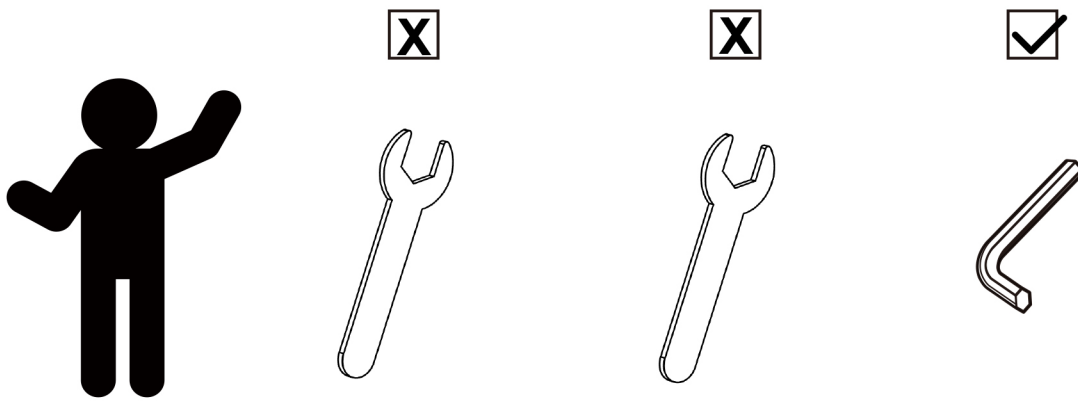

\*\* Got questions? Please have your product code (on the first page of this instruction, e.g. TD-12345A) and the order number ready, give us a call or email us through our customer care support! We are always ready to assist you!



**3D Interactive Instruction**

**[www.teamsonhome.com](http://www.teamsonhome.com)**

**Serving you well gives us great joy!**

**USA . . . . +1(800)935-3959**

Mon - Fri 10:00am ~ 2:00pm EST

✉ [support@teamson.com](mailto:support@teamson.com)

**EU . . . . . +44(0)1952-916-050**

Mon - Thu 9:00am ~ 5:00pm GMT

Friday 9:00am ~ 4:00pm GMT

✉ [support@teamson.co.uk](mailto:support@teamson.co.uk)

**ASIA . . . . 深圳办公室:**

**+86(0755)8885-3558.分机号108**

Mon - Sat 9:00am ~ 5:00pm GMT+8

✉ [sales\\_ec@teamson.com](mailto:sales_ec@teamson.com)

台北办公室:















**+886(2)2556-6268**

Mon - Fri 9:00am ~ 5:00pm GMT+8

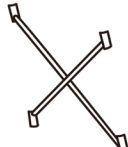
✉ [sales\\_ec@teamson.com](mailto:sales_ec@teamson.com)

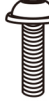
VNF-00114

PARTS LIST

<p>A</p>  <p>1PC</p>	<p>B</p>  <p>1PC</p>	<p>C</p>  <p>1PC</p>
<p>D</p>  <p>1PC</p>	<p>E</p>  <p>1PC</p>	<p>F</p>  <p>1PC</p>
<p>G</p>  <p>1PC</p>	<p>H</p>  <p>2PCS</p>	<p>I</p>  <p>2PCS</p>
<p>J</p>  <p>2PCS</p>	<p>K</p>  <p>Ø6X16MM</p> <p>20PCS</p>	<p>L</p>  <p>Ø6X13MM</p> <p>16PCS</p>
<p>M</p>  <p>Ø6X35MM</p> <p>4PCS</p>	<p>N</p>  <p>Ø6X25MM</p> <p>2PCS</p>	<p>O</p>  <p>Ø6X16X1.5MM</p> <p>26PCS</p>

**! Care Instructions**

Dust surface with a dry soft cloth.

Do not use window cleaners or cleaning abrasives as they will scratch the surface and could damage the protective coating

**! WARNING**

Small parts and sharp edges may be present prior to assembly.

# Step 1

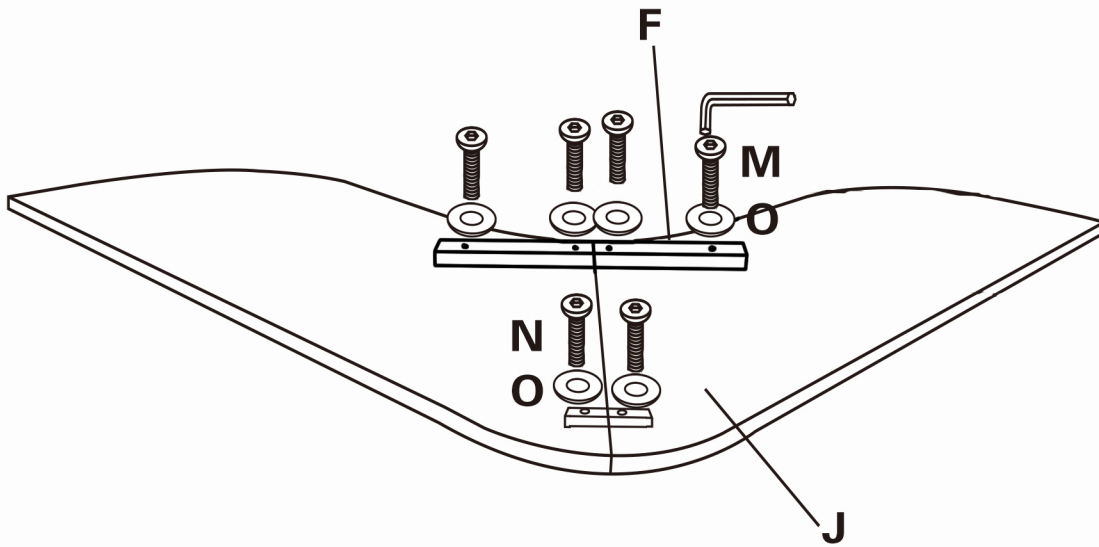

# Step 2

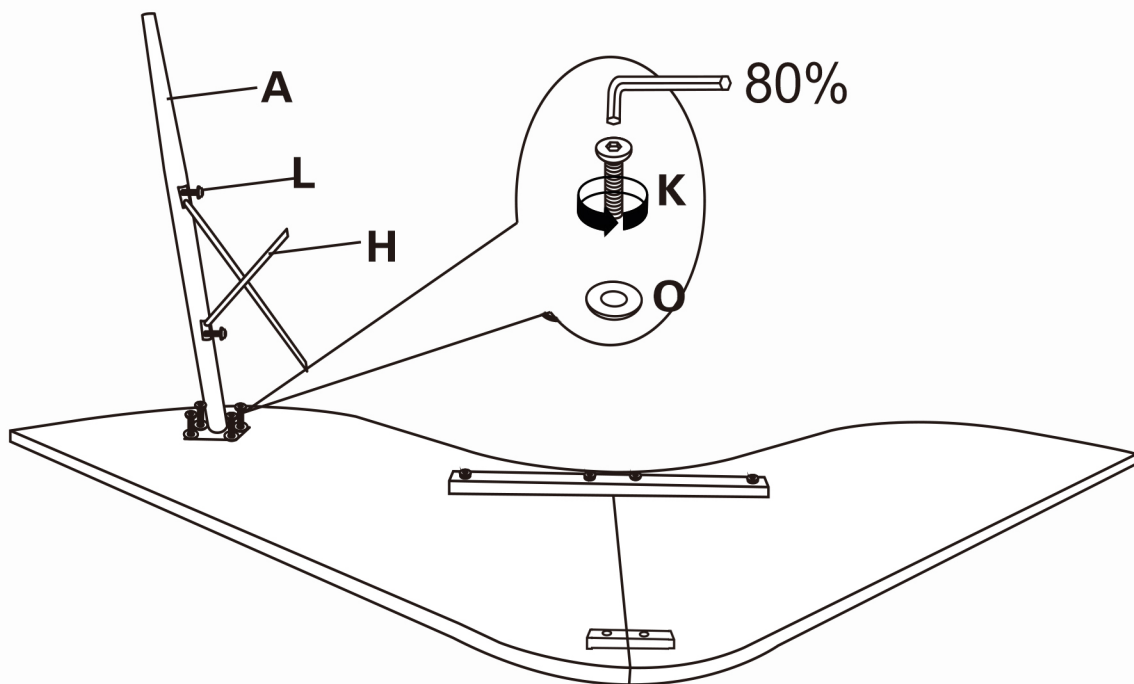

# Step 3

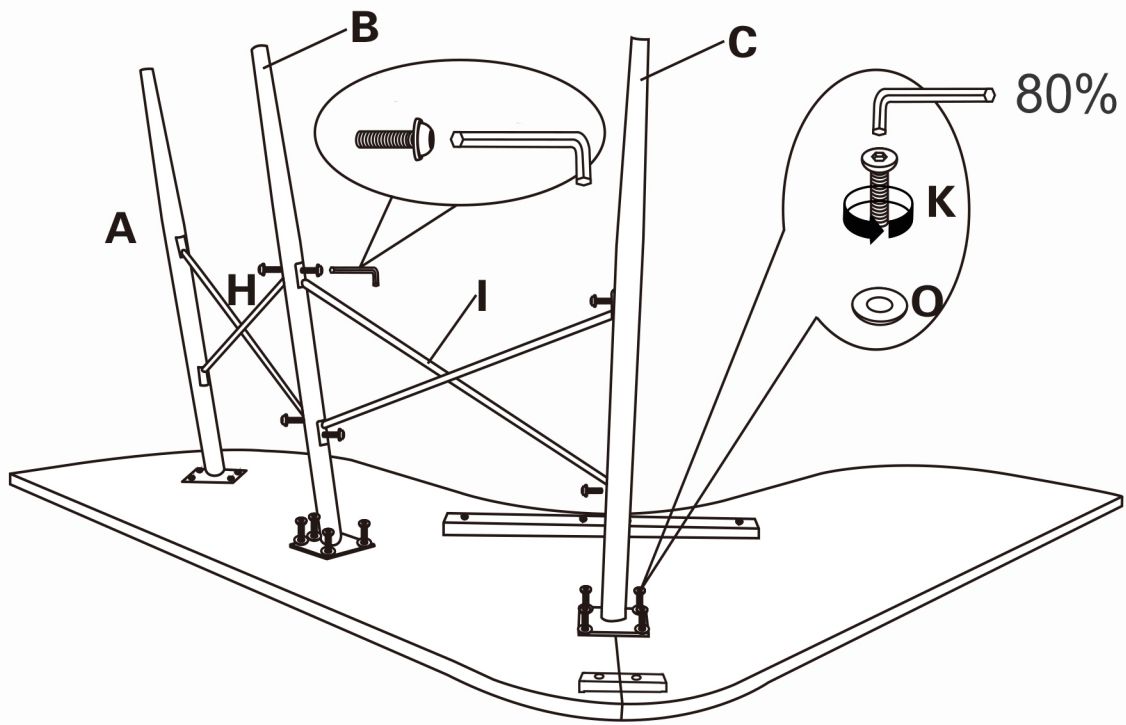

# Step 4

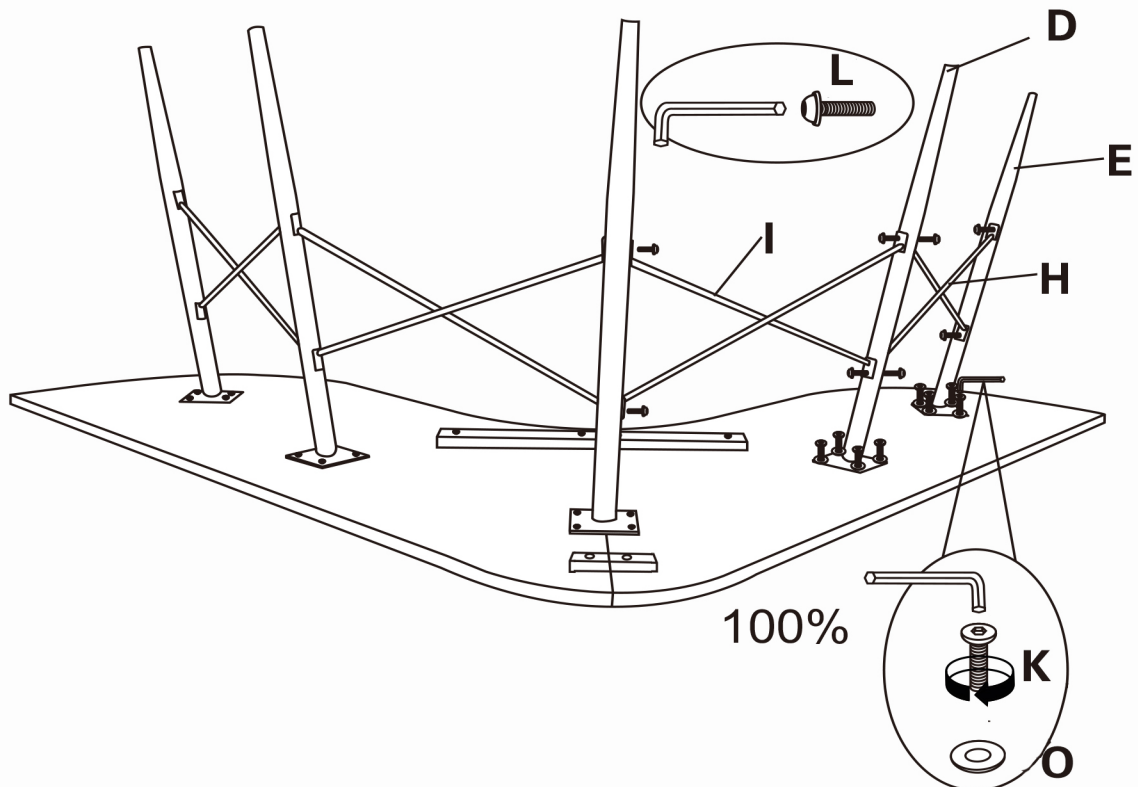

# Exploded Drawing

## FULL ASSEMBLY

