

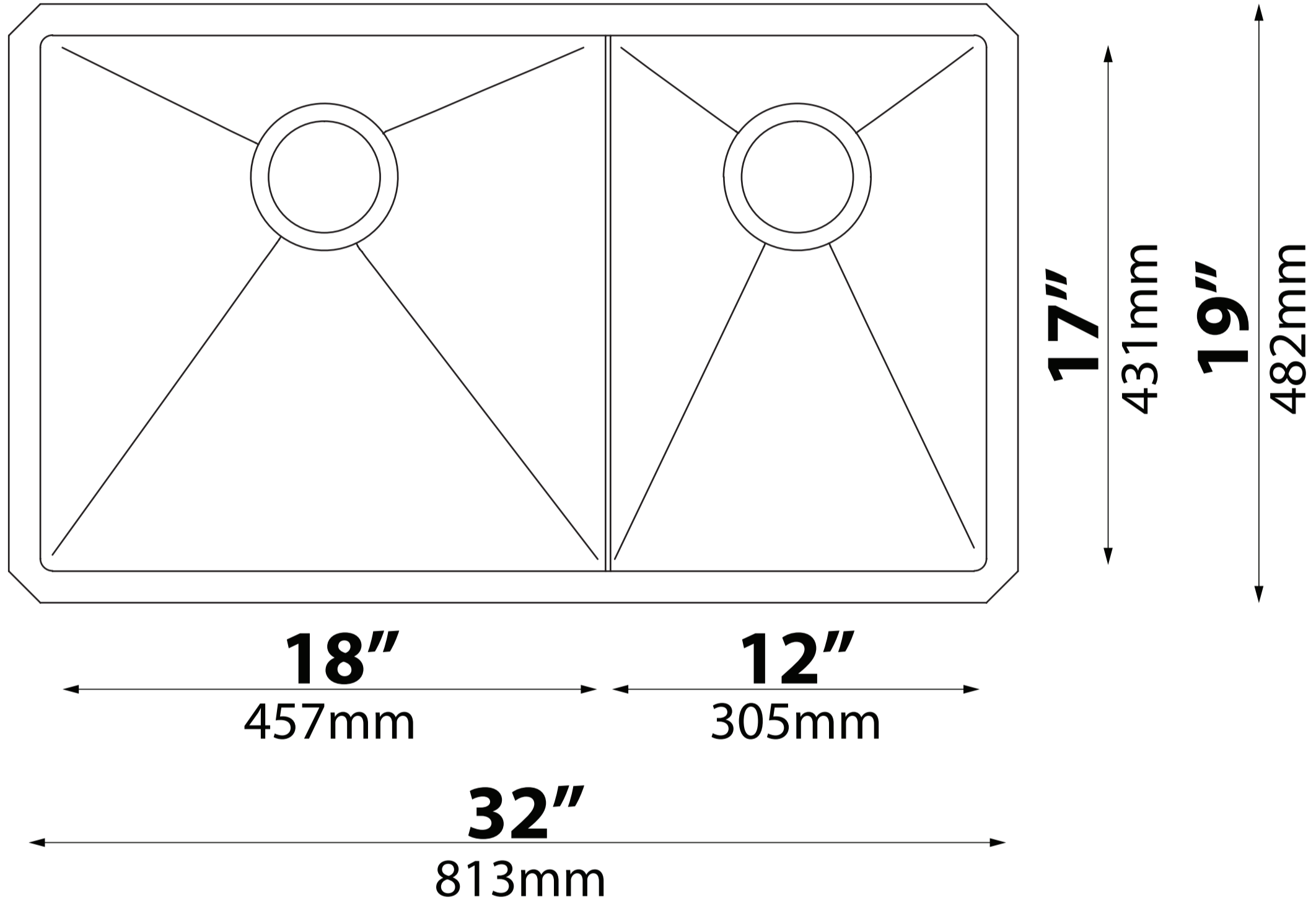

**Model No.
KHU103-32**

Pro Hotline: 516.801.8955
Customer Service: 800.775.0703

NOTE: Cutout template is provided as a guide **ONLY** and must be checked against actual sink to verify correct fit.



- Please cut along inner solid line for negative reveal 1/8"
- Please tear perforated edge for zero / flushed reveal
- Please use outer edge for positive reveal 3/8"