

PAIGE / MULBERRY / DENNING

48 inch VANITY with TOP

MODEL # AXCVPAWG-48

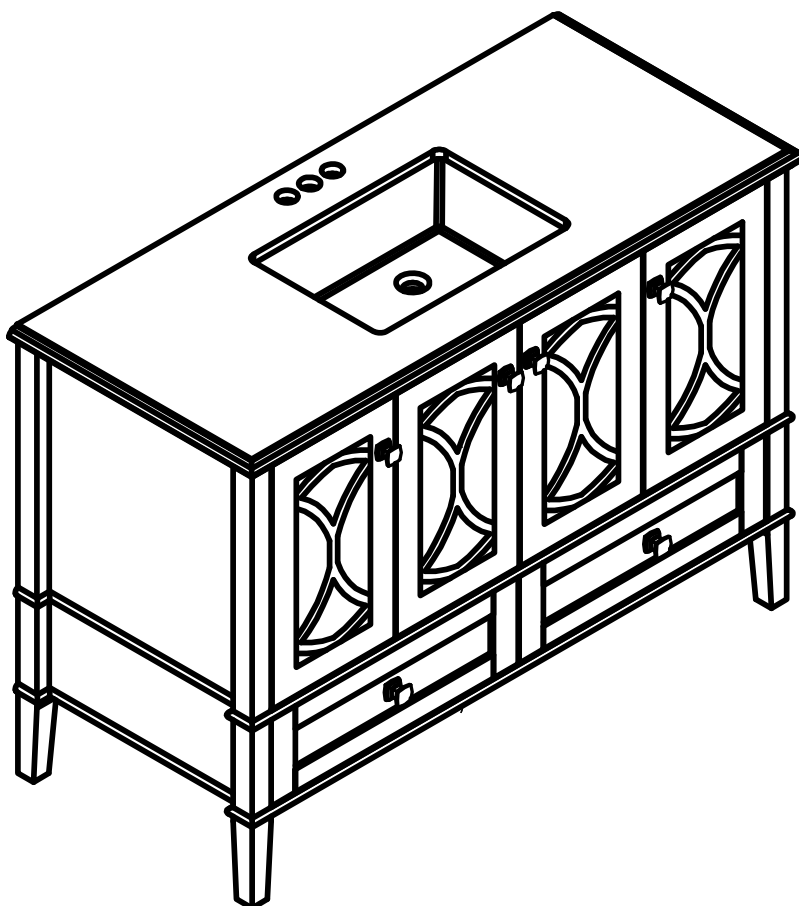



Questions, problems, assembly help, missing parts?

No need to return the product, we will gladly help and ship your replacement parts free of charge

Please call Customer Service at 1-866-518-0120 ext. 262

Monday to Friday between 9 am – 4 pm EST

or go to

www.simpli-home.com/parts request

In order to assist you in a timely manner, please have the following information ready:

Model # _____ Part Number or Letter _____

Purchased at _____ Date of Purchase _____

If you wish to return the product, please contact the retailer where the product was purchased.

IMPORTANT: Please read this manual carefully before beginning assembly of this product. Keep this manual for future reference.

SAFETY INFORMATION

After opening the box, remove the packing materials. When removing vanity top, always ensure it is removed vertically on its long edge. Support the vanity top firmly while removing it from the box. Do not set the vanity top down unsupported. Once properly installed, your vanity top will be supported on the cabinet and breakage will be very unlikely.

Requires 2 people for ease of assembly.

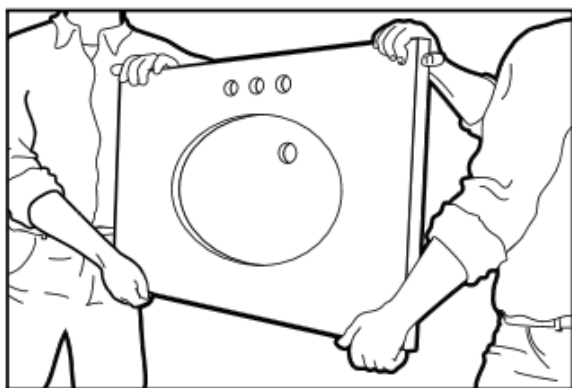

CORRECT

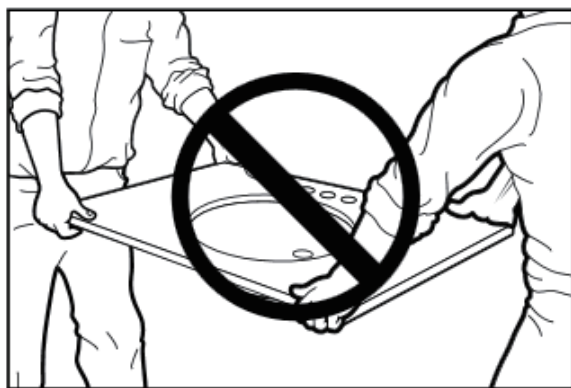

NOT CORRECT

IMPORTANT: Please read this manual carefully before beginning assembly of this product. Keep this manual for future reference.

CARE and MAINTENANCE

For regular cleaning, use a damp cloth with warm water, rinse and dry thoroughly to prevent streaks.

Wipe off any spills immediately. Liquid spills; such as shaving cream, toothpaste, perfume, cologne, nail polish remover, hair coloring and perm products, shampoo, drain and toilet bowl cleaner, alcohol, medications, etc. should be cleaned up promptly.

NEVER use abrasive cleaners, tub and tile cleaner, toilet cleaner, or rough cleaning pads. These types of cleaners can etch or dull stone surfaces. If necessary, a soft buffing pad can be used.

Do not stand on the vanity top to fix overhead lights or other items. Do not place extremely heavy items on the top.

PRE-ASSEMBLY INFORMATION

PARTS DESCRIPTION

A

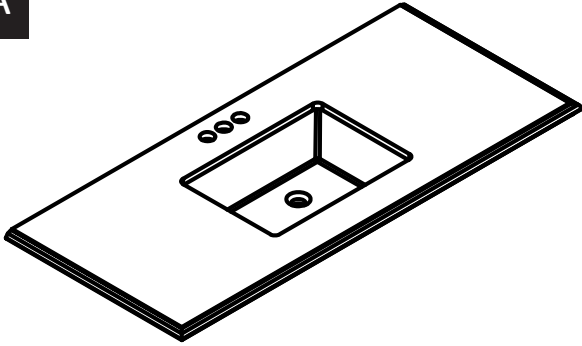

VANITY TOP
QTY 1

B

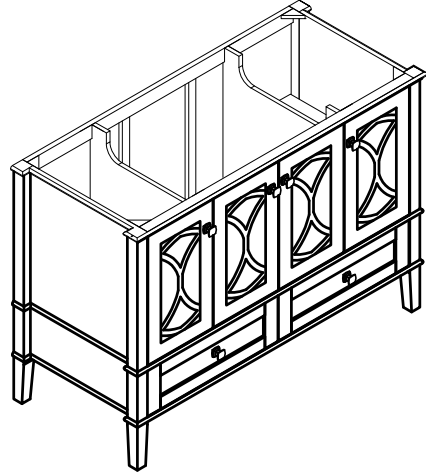

CABINET
QTY 1

TOOL REQUIRED

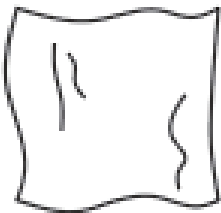

CLOTH

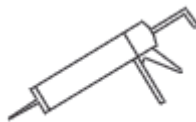

SILICONE



LEVEL

NEED HELP? For help with assembly or if you are missing a part,
Please call customer service at 1-866-518-0120 ext. 262 (9 am to 4 pm EST)

COMPONENTS – KEY DIAGRAM

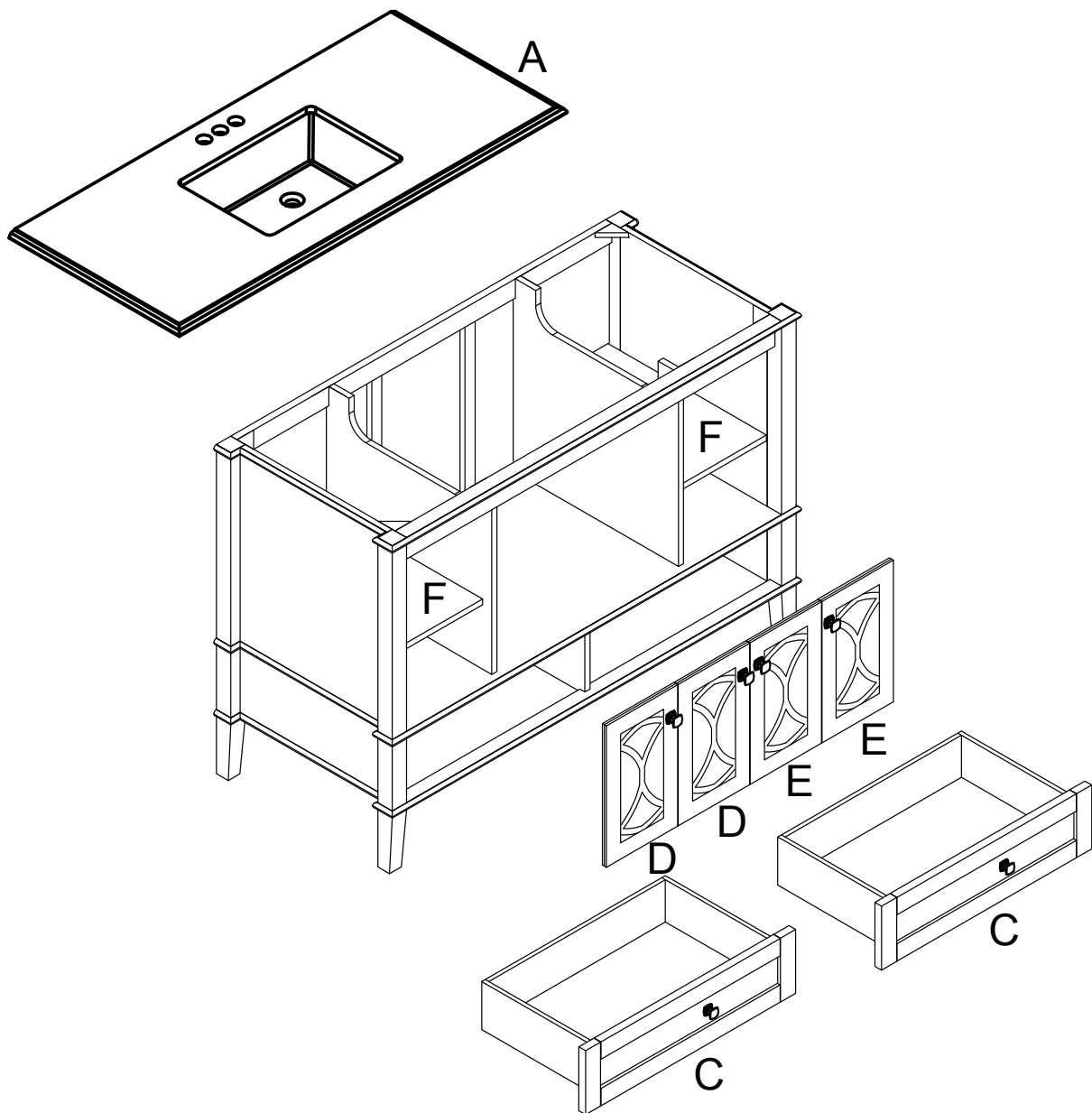

A	TP	Vanity Top
C	BDW	Bottom Drawer
D	DR-L	Left Door
E	DR-R	Right Door
F	SHLF	Shelf

ASSEMBLY

NOTE: Consult professional help if you are not familiar with installing bathroom cabinetry and working with associated plumbing hardware and tools. Installing a vanity cabinet and vanity top will require more than one person.

NOTE: We recommend the water lines and drain be roughed in prior to installing the unit. The plumbing and vanity should be installed by an experienced plumber.

STEP 1 Prepare the Cabinet

- Remove the foam between the vanity top (A) and the cabinet (B).
- Clean the top of the cabinet (B) with a cloth.
- Clean the floor beneath where the vanity will sit and ensure the floor is level.
- Level the cabinet (B) side-to-side, front to back and diagonally.
- Trial fit the vanity top (A) on the cabinet (B) to ensure it is the correct size, fit and that it is level.
- Secure the cabinet (B) to the wall if desired.

STEP 2 Install the Faucet

- While supporting the vanity top (A) carefully, install the faucet according to the manufacturer's instructions.

NOTE: Faucet not included with this vanity.

ASSEMBLY

STEP 3 Install the Vanity Top

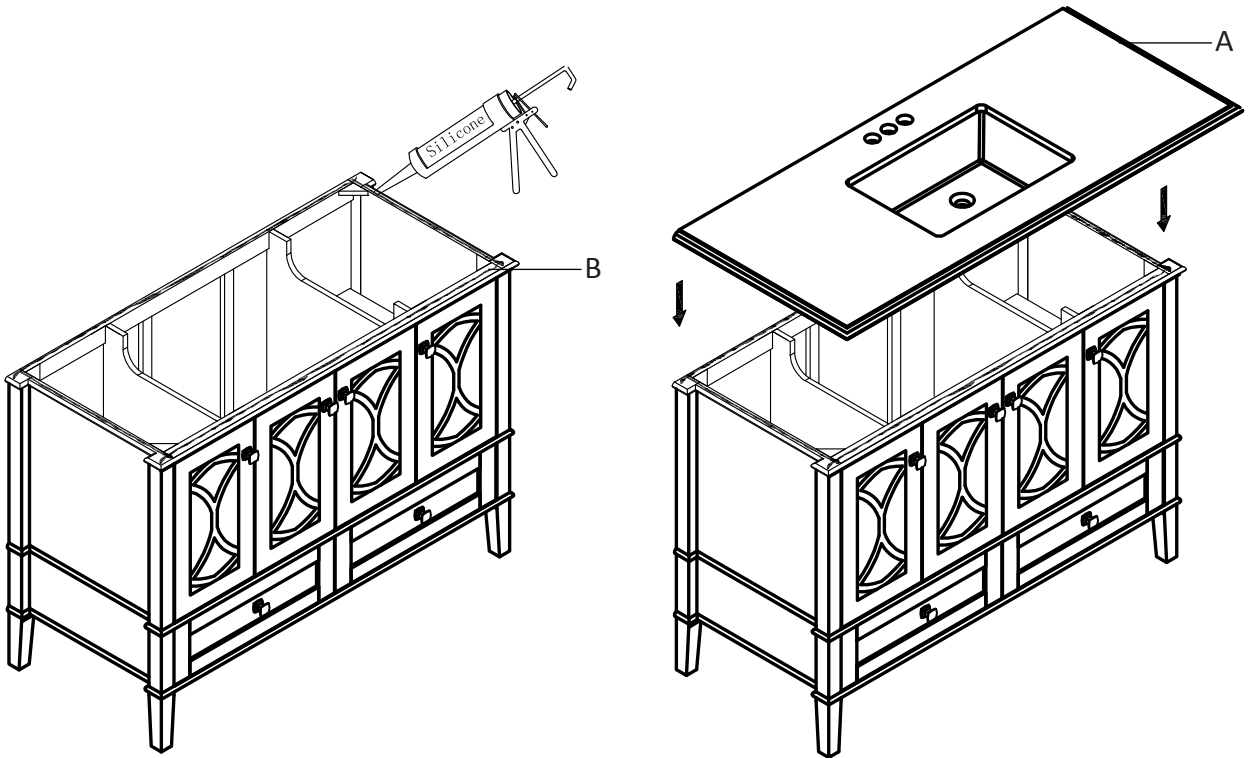

- Apply a 1/4 inch continuous bead of Construction Adhesive or Silicone (not included) evenly along the top of the cabinet (B).
- Gently place the vanity top (A) on the cabinet (B). This will require two people.
- The vanity top (A) must be flush with the back of the cabinet (B). Standard size tops are designed with a 1/2 inch overlap on each side of the cabinet except the back of the cabinet.
- Ensure the vanity top (A) is correctly positioned before the Construction Adhesive or Silicone dries or becomes permanent (follow adhesive manufacturer's instructions).
- Have a soft cloth ready to wipe off any excess sealant should it compress over the edge and onto the finished sides. Allow it to dry according to the adhesive manufacturer's instructions (24 hours recommended).

ASSEMBLY

STEP 4 Adjusting the Levelers

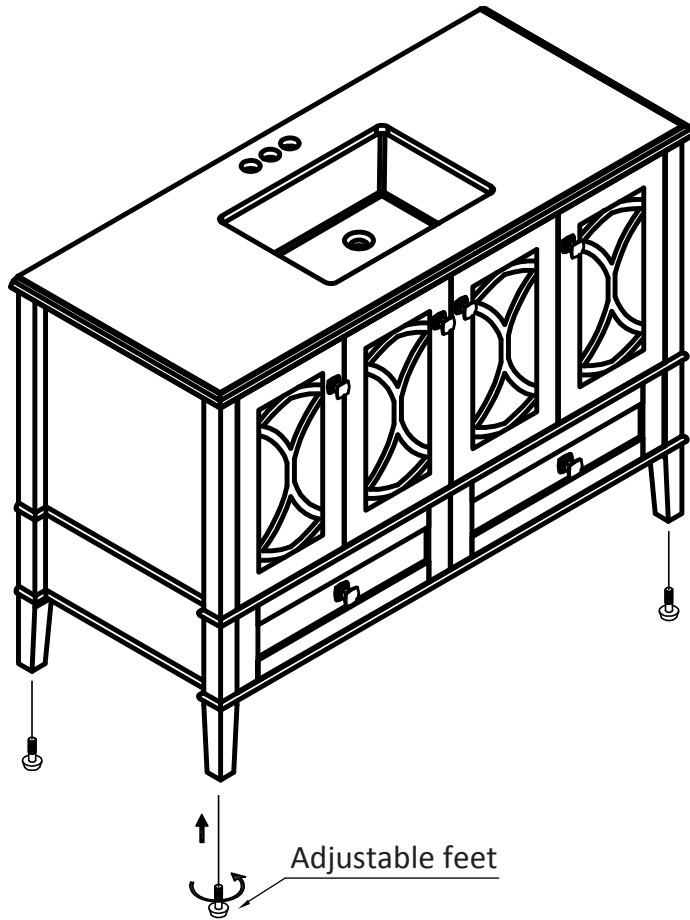

- If the floor is uneven, the adjustable feet levelers can be rotated to raise the vanity to the desired height.

ASSEMBLY

STEP 5 Fixing Adjustable Hinges

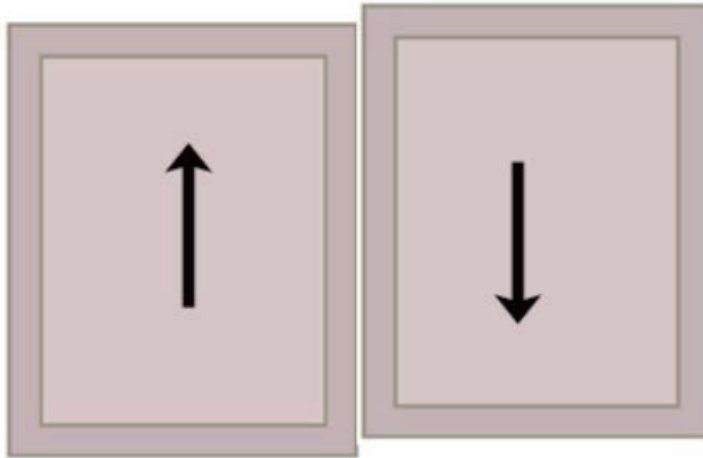

To change the vertical height.

- Undo the two adjustable cabinet screws on both hinges
They are usually in slotted holes which means you can adjust up or down by a few mm
- Then tighten the screws back up

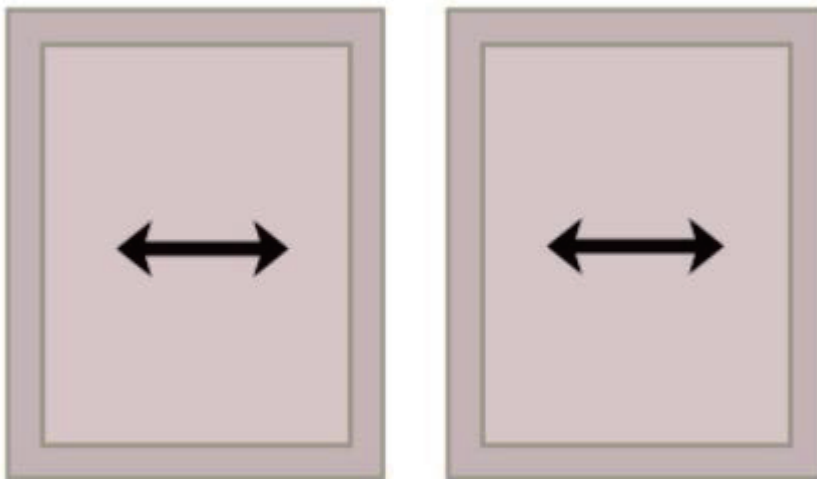

To adjust the doors side to side

- Slightly turn the adjustable screws on both hinges on each door
- You may have to slightly release the locking screw to do this
- Make sure it's tight afterwards

ASSEMBLY

STEP 5 Fixing Adjustable Hinges (cont'd)

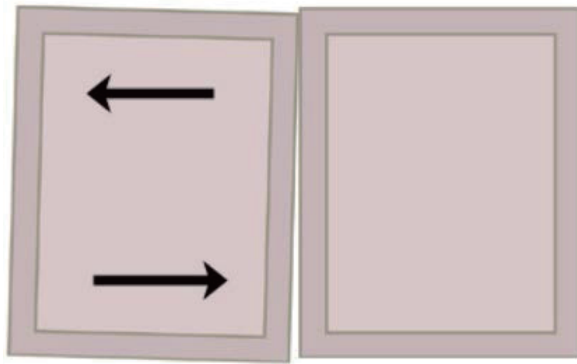

To adjust the angle of a cabinet door

- Adjust only the screw either on the top or bottom
- For larger adjustments, turn the screw on the top one way and the screw on the bottom the other way
- You may need to slightly release the locking screw to do this
- Make sure it's tight afterwards

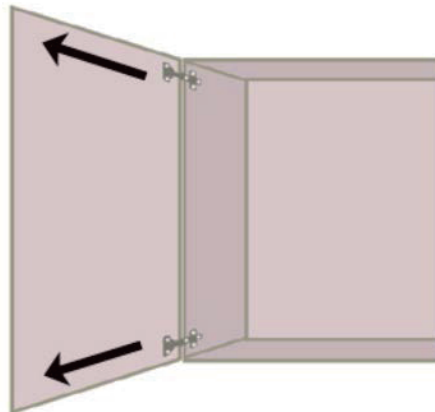

To adjust doors not closing properly

Look at the side where the hinges are as you close the door. The door may be touching the cabinet frame as it closes (binding).

- To fix this you need to adjust the door out towards you slightly
- Unscrew the locking screw on both hinges
- The door should slide in and out a little
- Pull it towards you slightly and re-tighten
- The ideal gap should not be any more than 1 mm



WARRANTY

Thank you for purchasing a **Simpli Home – Wyndenhall – Brooklyn + Max** product. These products have been made to demanding, high-quality standards and are guaranteed for domestic use against manufacturing faults for a period of 12 months from the date of purchase. This warranty does not affect your statutory rights.

In case of any malfunction of your product (failure, missing parts, etc.) please contact us at our toll free service line at 1-866-518-0120 ext. 262 from 9 am to 4 pm, Monday to Friday, Eastern Standard Time or by email at customerservice@simpli-home.com.

We reserve the right to repair or replace the defective product, at its discretion.

This product is guaranteed for 12 months if used for normal purposes. Any warranty is invalid if the product has been overloaded or subject to neglect, improper use or an attempted repair by other than an authorized agent. Heavy-duty or daily professional/commercial usage are not guaranteed.

Due to continuous product improvement, we reserve the right to change the product specifications without prior notice.