

SIMPLIHOME®

Skyler / Rhonda / Glenna

C Side Table With Inlay

MODEL # AXCSKY-09NLB

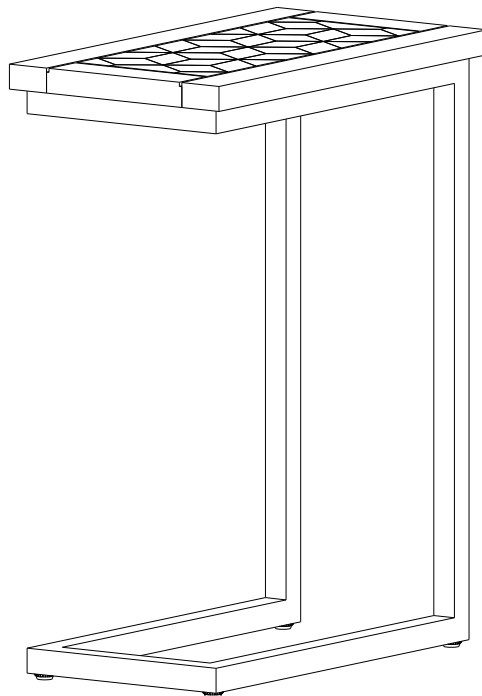

SIMPLIHOME®

Great quality is a right.

Thank you for shopping with Simpli Home,
America's top brand for high-value furniture.



It's time to register your product warranty.

It's quick and easy. And you'll be happy you did.



- ✓ Activate your **1-year** warranty
- ✓ Automatic entry to win a **\$500** gift certificate
- ✓ Earn instant rewards and **save**

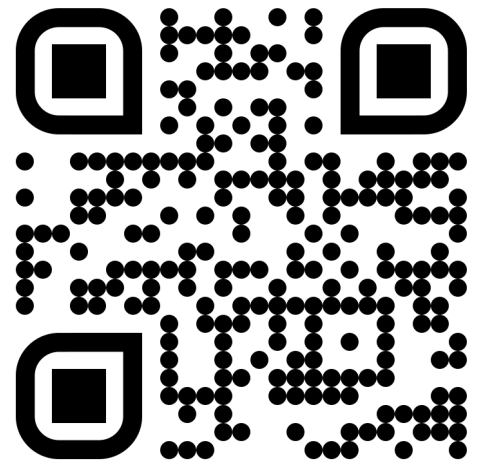

simpli-home.com/product-registration

SIMPLIHOME®

Review your product and collect rewards!

Thank you for your purchase! We hope you enjoy it. We'd love your feedback. Please share a review and get instant rewards!

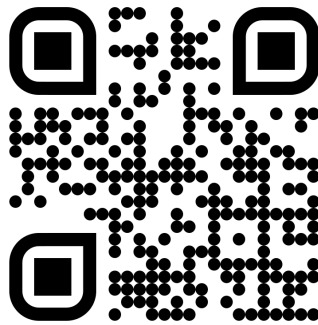

simpli-home.com/product-review



Share photos and get your cash back!



Send us images or share them on social and qualify for instant rewards. You may even receive store credit on your entire purchase!

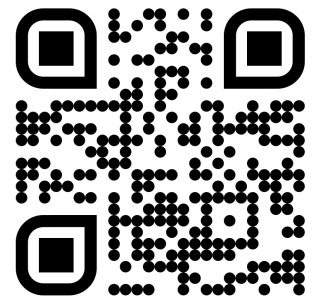
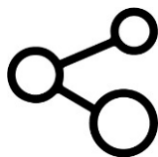

simpli-home.com/share-images

SIMPLIHOME®

For fastest customer service

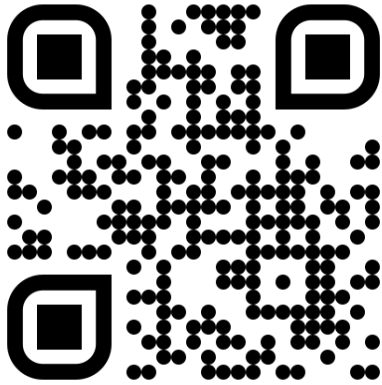

1. Open your phone's camera.
2. Point your phone's camera at the QR code to scan.
3. Click on the pop up.
4. You'll be taken to our customer service page.
5. Fill the form with your order information and issue.
6. Submit form.
7. A customer service associate will contact you.

Other ways to contact us...



Email Us

customerservice@simpli-home.com



Visit Us

Visit our site directly at
www.simpli-home.com



Call Us

1-866-518-0120
Monday to Friday
9am to 5pm EST

***If you've purchased from a retailer and you wish to return the product, please contact the retailer directly.**

Care & Maintenance

This furniture is designed for indoor use.

Damage to furniture can come from temperature changes in relative humidity (RH) in our homes. Humid air oxidizes metal which results in rusting, corrosion, tarnishing and roughness.

Wood absorbs water as relative humidity rises and falls, and in doing so it swells and shrinks.

To protect against the humidity effect, the metal is powder coated. The powder coat layer protects the metal from oxidizing, corrosion, tarnishing and scratching and keeps it looking good for years to come. The wood is sealed and lacquered to protect against humidity.

To help protect your furniture, follow these steps:

- Use a humidifier, preferably one with an automatic control system that can sense the humidity level and adjust itself accordingly
- Dust with soft dry cloth
- Wipe up spills promptly
- Clean with a dry cloth
- Do not use abrasive cleaners, chemical solvents, strong detergents, cleaners with bleach, and furniture polish
- Use soft felt base coasters, placemats to help prevent scratches
- Keep furniture out of direct sunlight, which can cause cracking or roughness on the protective layer
- If it can be avoided, do not put furniture near heating vents
- Keep the furniture 3 to 4 inches away from the wall, giving heat and air space to circulate

Step 1

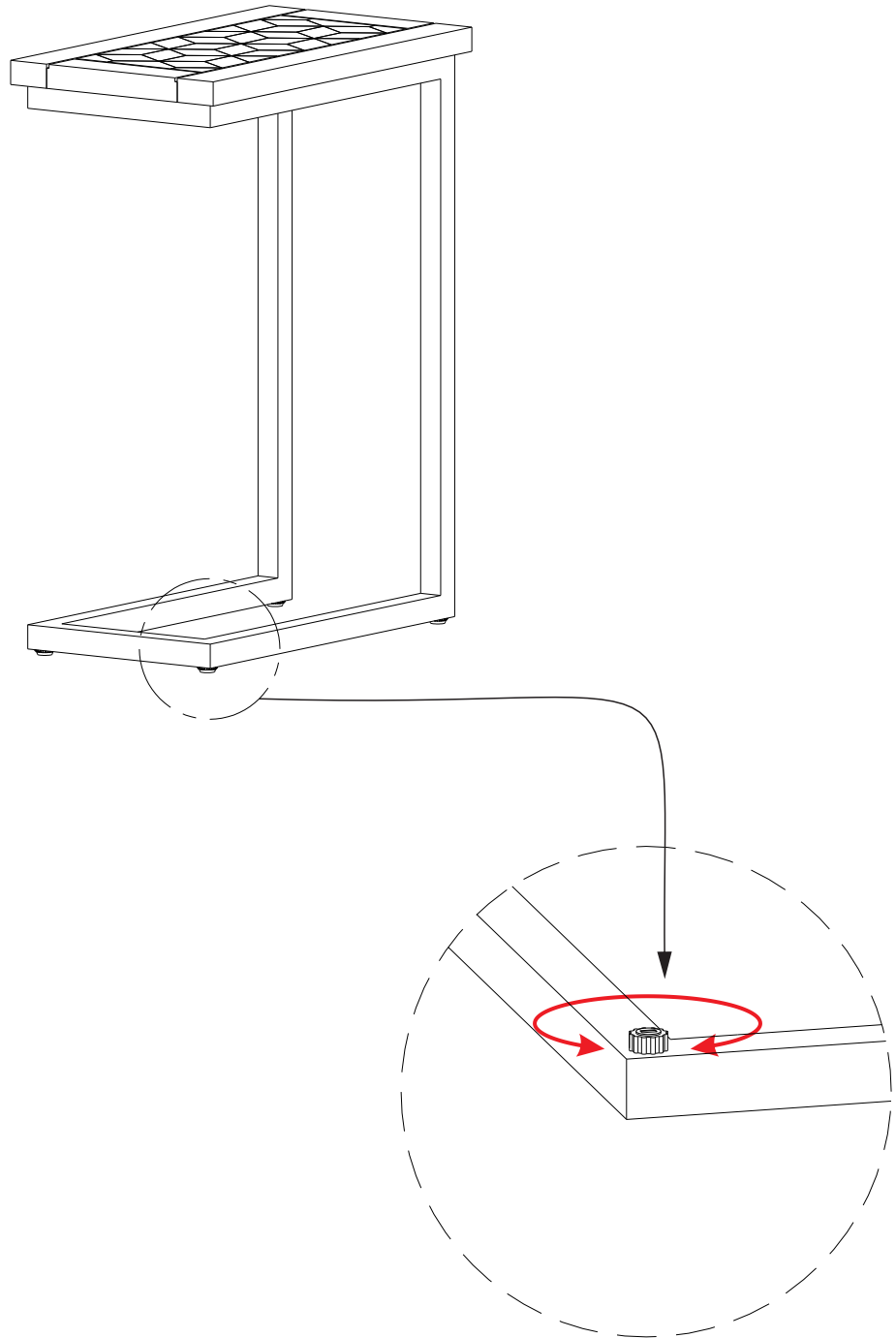

Note: Levelers on bottom of base can be adjusted if floor is uneven.