

SIDES	BOTTOM
Material:Steel-316 Stainless steel	

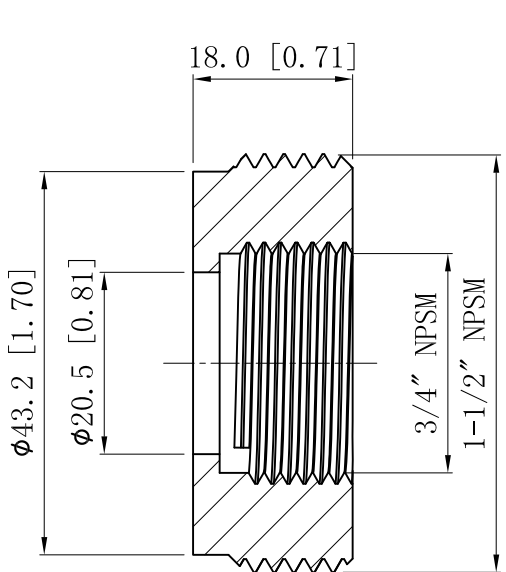

CUTAWAY VIEW A-A

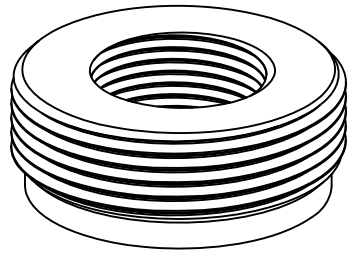
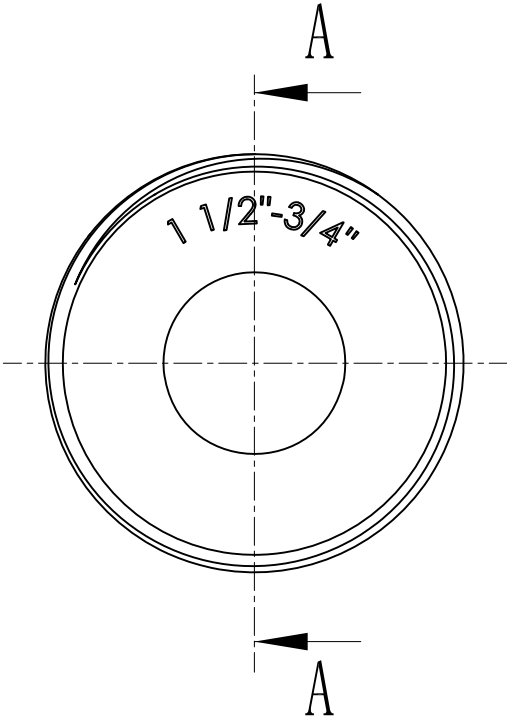

DESCRIPTION
TRADE REFERENCE TERMS

This data sheet is for reference only .GARVIN INDUSTRIES reserves the right to make changes to the design without prior notice.

STANDARD PACKING	<h1 style="text-align: center;">GARVIN INDUSTRIES</h1> <h2 style="text-align: center;">STEEL REDUCING BUSHING</h2>						
10 PCS							
	<table border="1" style="width: 100%;"> <tr> <td>SIZE</td> <td>DWG NO.</td> <td>REV</td> </tr> <tr> <td>A4</td> <td>RB-15075-SS</td> <td>A</td> </tr> </table>	SIZE	DWG NO.	REV	A4	RB-15075-SS	A
SIZE	DWG NO.	REV					
A4	RB-15075-SS	A					
		DATA SHEET					