

SIDES	BOTTOM
Material: Steel-0.385"- Q235, Zinc plated	

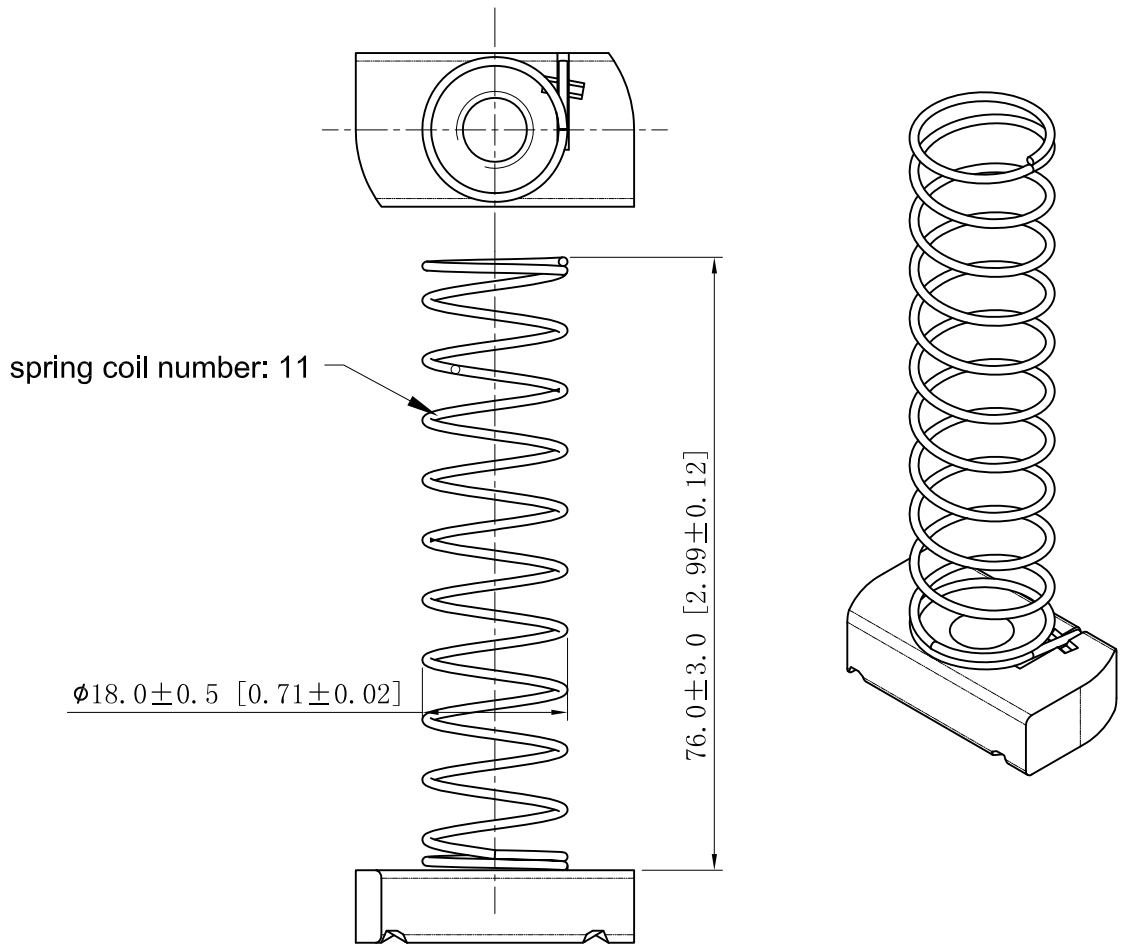
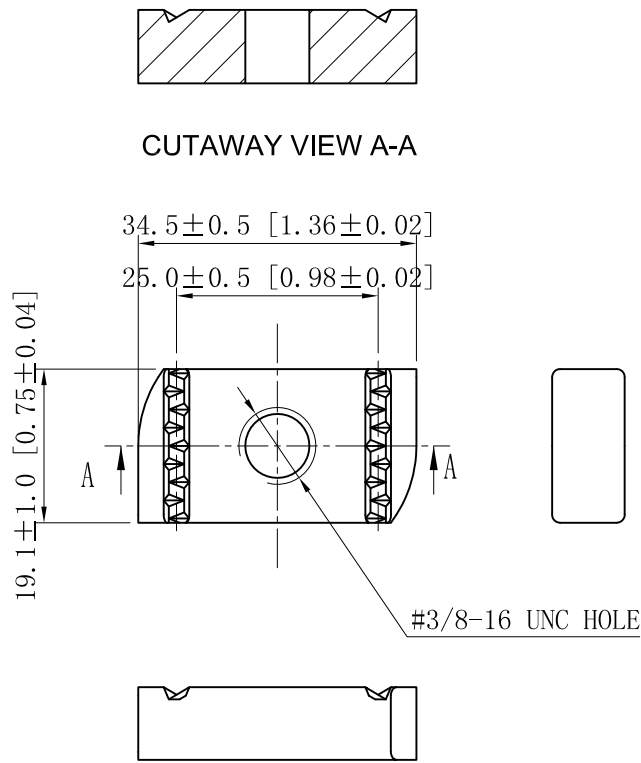

DESCRIPTION
TRADE REFERENCE TERMS

STANDARD PACKING
50 PCS

This data sheet is for reference only .GARVIN INDUSTRIES reserves the right to make changes to the design without prior notice.

GARVIN INDUSTRIES		
TITLE		
SIZE	DWG NO.	REV
A4	SNLS3816	
DATA SHEET		