

# FRANKLIN SIDEBOARD

## ASSEMBLY INSTRUCTIONS



A. SIDEBOARD

1 PC

B. LEG

4 PCS

C. CENTER SUPPORT LEG

1 PC

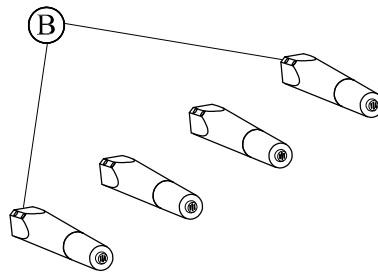
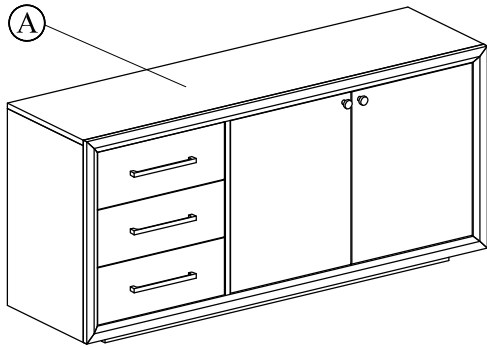

### FULLY ASSEMBLED



### HARDWARE KIT PACKED IN BOX

1	ALLEN BOLT (8x55mm)		8 PCS
2	LOCK WASHER (M9)		8 PCS
3	FLAT WASHER (M8)		8 PCS
4	ALLEN KEY		1 PC
5	TIPPING RESTRAINT		1 SET

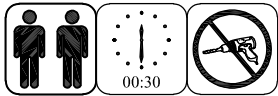

### STEP 1

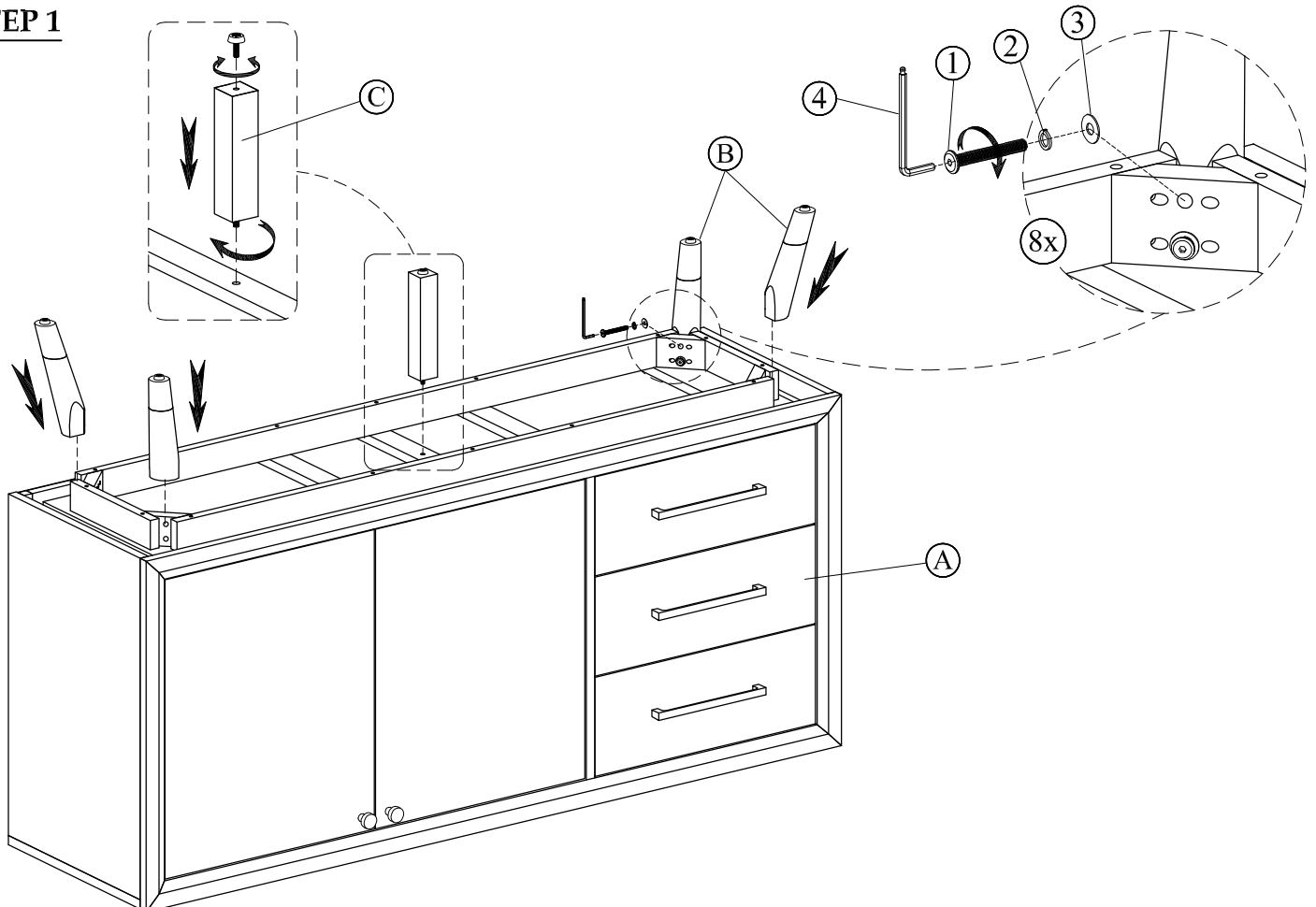

# FRANKLIN SIDEBOARD

## ASSEMBLY INSTRUCTIONS



### STEP 2

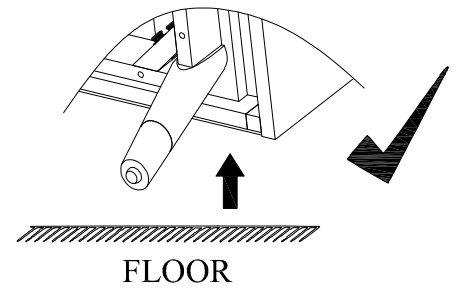
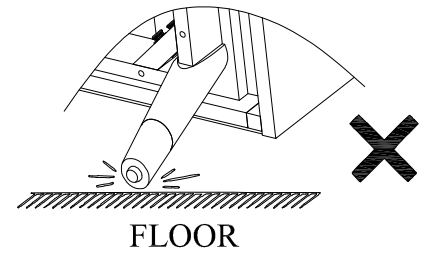
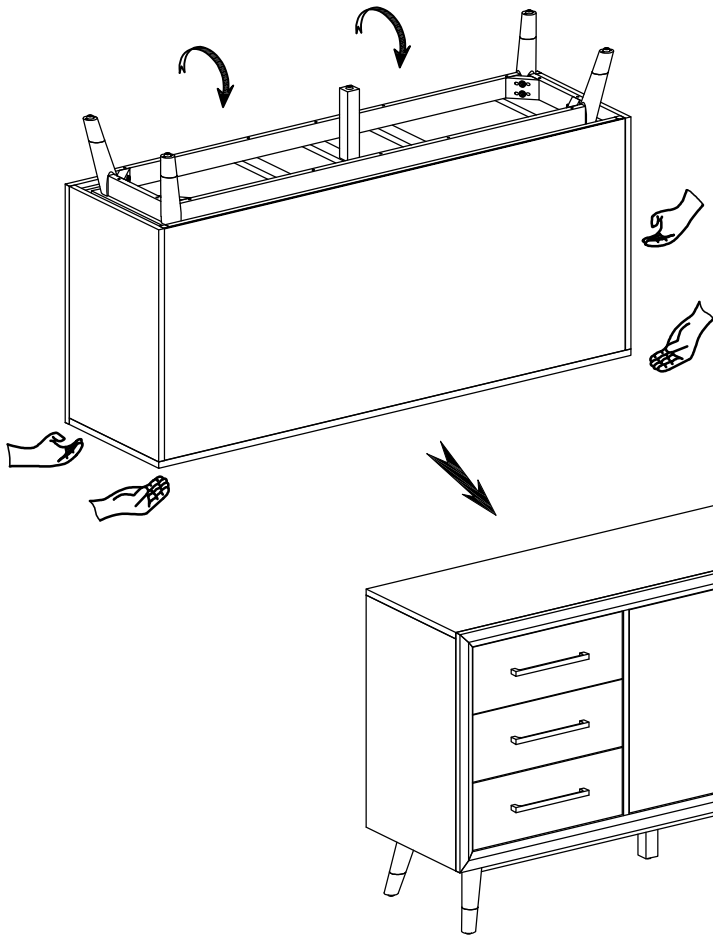

### STEP 3



ASSEMBLY COMPLETE