

BRENTWOOD 7.5' AIR HOCKEY TABLE - NG1036H

Spec Sheet

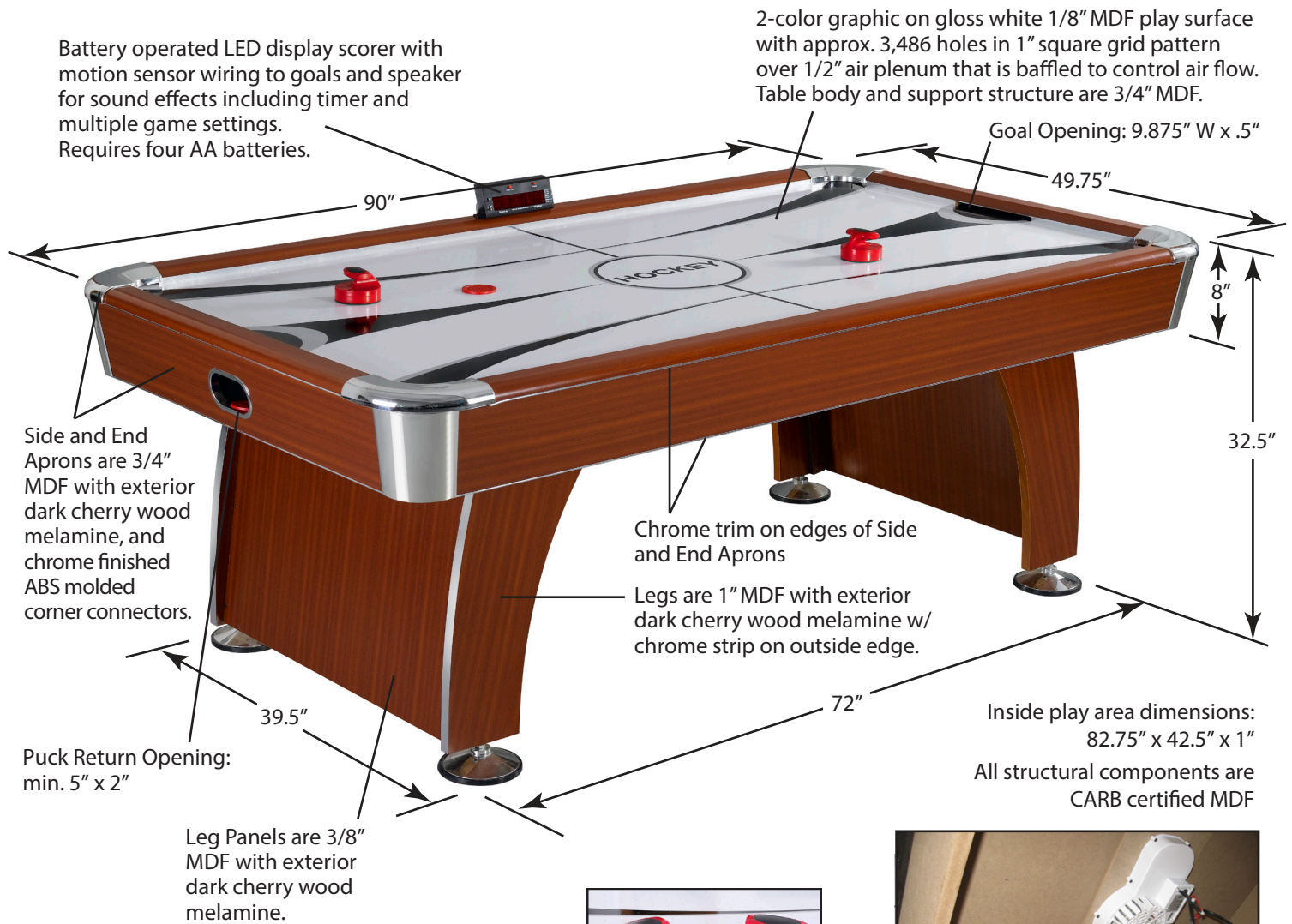

Accessories:

Includes four 4" dia. upgrade "comfort fit" strikers & four 3" dia. dimpled red pucks



UL approved ON/OFF switch and blower motors

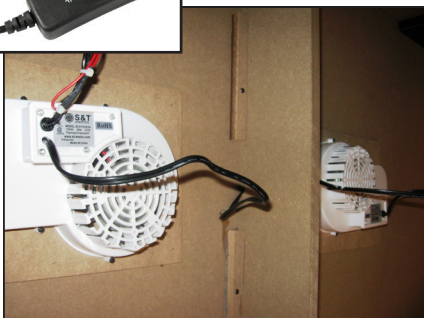

Two securely mounted turbo blade blowers, AC120V 60 Hz 0.31A, with a min. 9" x 12" mounting boards.



8" x 3' x 2.25" LED electronic timer and scoring system with multiple game options. Requires 4 AA batteries.









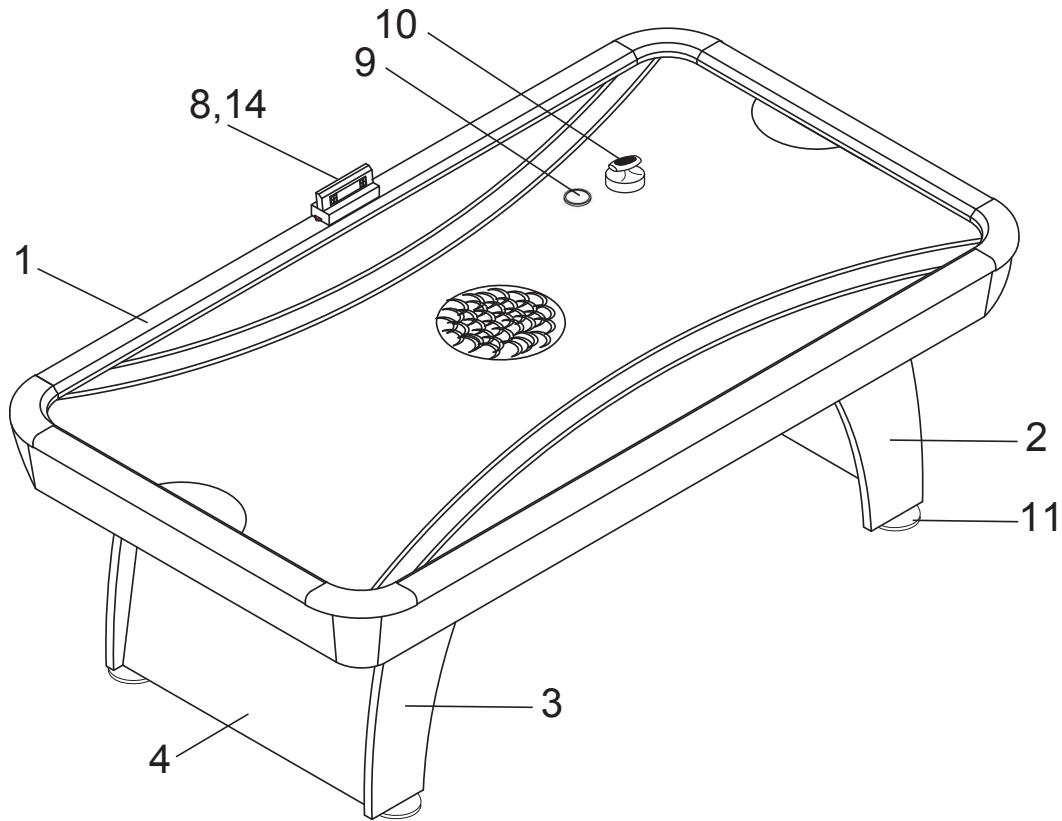

3/4" MDF support structure and leg attachment method.

BRENTWOOD 7.5' AIR HOCKEY TABLE - NG1036H

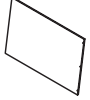



Spec Sheet



PARTS

#1 NGP5962 90" x 49.75" x 8" 3/4" MDF  TABLE BODY x1	#2 NGP5963 28.25" x 11" 1" MDF  LEFT LEG x2	#3 NGP5964 28.25" x 11" 1" MDF  RIGHT LEG x2	#4 NGP5965 32.75" x 20.625" 3/8" MDF  LEG PANEL x2	#8 NGP5854 8" x 3" x 2.25", 4 AA batteries reqd.  ELECTRONIC SCORER x1	#9 NGP5774 3" Dia. x 1/8" ABS Plastic  PUCK x4	#10 NGP5993 4" Dia. x 2.5" H ABS Plastic w/ Felt Pad  STRIKER x4
#11 NGP5855 6" Dia. x 2" ABS & Metal  LEG LEVELER x4	#1 NGP5764 Two AC 120V Blowers Pre-installed on Table Body  BLOWER MOTOR	#14 NGP58541 (A & B wires: 1 wire set per goal) SCORER SENSOR WIRE	<i>All dimensions given are approx. and represent the size at the widest point of that dimension.</i>			

HARDWARE PACK - NGP5853 (sealed in individual numbered poly bags and then bagged as set)

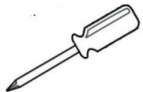
#5 x12  FLAT WASHER	#6 x12  1-3/4" SCREW	#7 x2  1/2" SCREW	#12 x1  HEX WRENCH	#13 x12  BOLTS	ADDITIONAL EQUIPMENT REQUIRED:  PHILLIPS HEAD SCREWDRIVER
---	--	---	--	---	--