



C 588

Turntable

ENGLISH



Owner's Manual

IMPORTANT SAFETY INSTRUCTIONS

PRECAUTIONS

Read the Operating Instructions carefully and completely before operating the unit. Be sure to keep the Operating Instructions for future reference. All warnings and cautions in the Operating Instructions and on the unit should be strictly followed, as well as the safety suggestions below.

INSTALLATION

- Water and Moisture** - Do not use this unit near water, such as near a bathtub, washbowl, swimming pool, or the like.
- Heat** - Do not use this unit near sources of heat, including heating vents, stoves, or other appliances that generate heat. It also should not be placed in temperatures less than 5°C (41°F) or greater than 35°C (95°F).
- Mounting surface** - Place the unit on a flat, even surface.
- Ventilation** - The unit should be situated with adequate space around it so that proper ventilation is assured. Allow 10 cm (4 inches) clearance from the rear and the top of the unit, and 5 cm (2 inches) from each side. Do not place on a bed, rug, or similar surface that may block the ventilation openings. Do not install the unit in a bookcase cabinet, or airtight rack where ventilation may be impeded.
- Objects and liquid entry** - Take care that objects or liquids do not get inside the unit through the ventilation openings.
-  **Carts and stands** - When placed or mounted on a stand or cart, the unit should be moved with care. Quick stops, excessive force, and uneven surfaces may cause the unit and cart to overturn or fall.
- Wall or ceiling mounting** - The unit should not be mounted on a wall or ceiling, unless specified in the Operating Instructions.

WARNING!

TO REDUCE THE RISK OF FIRE OR ELECTRONIC SHOCK, DO NOT EXPOSE THIS APPLIANCE TO RAIN OR MOISTURE



This product is manufactured to comply with the radio interference requirements of EEC DIRECTIVE 89/68/EEC and 73/23/EEC

ELECTRIC POWER

- Power Sources** - Connect this unit only to power sources specified in the Operating Instructions, and as marked on the unit.
- Polarization** - As a safety feature, some units are equipped with polarized AC power plugs which can only be inserted one way into a power outlet. If it is difficult or impossible to insert the AC power plug into an outlet, turn the plug over and try again. If it still does not easily insert into the outlet, please call a qualified service technician to service or replace the outlet. Avoid defeating the safety feature of the polarized plug, do not force it into a power outlet.
- AC power cord** - When disconnecting the AC power cord, pull it out by the AC power plug. Do not pull the cord itself. Never handle the AC power plug with wet hands, as this could result in fire or shock. Power cords should be routed to avoid being severely bent, pinched, or walked upon. Pay particular attention to the cord from the unit to the power socket. Avoid overloading AC outlets and extension cords beyond their capacity, as this could result in fire or shock.
- Extension cord** - To help prevent electric shock, do not use a polarized AC power plug with an extension cord, receptacle, or other outlet unless the polarized plug can be completely inserted to prevent exposure of the blades of the plug.
- When not in use** - The primary method of isolating the turntable from the mains supply is to disconnect the mains plug. Ensure that the mains plug remains accessible at all times. Unplug the AC power cord from the AC outlet if the unit will not be used for several months or more.

EXPLANATION OF GRAPHICAL SYMBOLS



The lightning flash with arrowhead symbol, within an equilateral triangle, is intended to alert the user to the presence of uninsulated "dangerous voltage" within the product's enclosure that may be of sufficient magnitude to constitute a risk of electric shock to persons.



The exclamation point within an equilateral triangle is intended to alert the user to the presence of important operating and maintenance (servicing) instructions in the literature accompanying the appliance.



CAUTION

Modifications or adjustments to this product, which are not expressly approved by the manufacturer, may void the user's right or authority to operate this product.

MAINTENANCE

Clean the unit only as recommended in the Operating Instructions.

DAMAGE REQUIRING SERVICE

Have the unit serviced by a qualified service technician if

- The AC power plug has been damaged.
- Foreign objects or liquid have got inside the unit.
- The unit has been exposed to rain or water.
- The unit does not seem to operate normally.
- The unit exhibits a marked change in performance.
- The unit has been dropped, or the cabinet has been damaged

DO NOT ATTEMPT TO SERVICE THE UNIT YOURSELF.

NOTES ON ENVIRONMENTAL PROTECTION



At the end of its useful life, this product must not be disposed of with regular household waste but must be returned to a collection point for the recycling of electrical and electronic equipment. The symbol on the product, user's manual and packaging, point this out.



The materials can be reused in accordance with their markings.

Through re-use, recycling of raw materials or other forms of recycling of old products, you are making an important contribution to the protection of our environment. Your local administrative office can advise you of the responsible waste disposal point.

INFORMATION ABOUT COLLECTION AND DISPOSAL OF WASTE BATTERIES (DIRECTIVE 2006/66/EC OF THE EUROPEAN PARLIAMENT AND THE COUNCIL OF EUROPEAN UNION) (FOR EUROPEAN CUSTOMERS ONLY)



Pb

Batteries bearing any of these symbols indicate that they should be treated as "separate collection" and not as municipal waste. It is encouraged that necessary measures are implemented to maximize the separate collection of waste batteries and to minimize the disposal of batteries as mixed municipal waste.



Hg

Cd

End-users are exhorted not to dispose waste batteries as unsorted municipal waste. In order to achieve a high level of recycling waste batteries, discard waste batteries separately and properly through an accessible collection

point in your vicinity. For more information about collection and recycling of waste batteries, please contact your local municipality, your waste disposal service or the point of sale where you purchased the items.

By ensuring compliance and conformance to proper disposal of waste batteries, potential hazardous effects on human health is prevented and the negative impact of batteries and waste batteries on the environment is minimized, thus contributing to the protection, preservation and quality improvement of the environment.

OWNER'S RECORD

For your convenience, record the model number and serial number in the space provided below. Please refer to them when you contact your dealer in case of difficulty.

Model No. :

Serial No. :

WHAT'S IN THE BOX

Packed with your C 588 you will find

- Switch mode power supply (SMPS) with interchangeable plugs
- Counterweight
- Audio cable connector (RCA-to-RCA lead)
- Single adaptor (for single LP's)
- Allen keys 1,5mm and 2mm for possible setting of the tonearm
- Stylus pressure gauge
- Plastic tool for tonearm bearings
- Paper cartridge alignment tool with two null points
- Black felt mat for the platter
- White cotton gloves

SAVE THE PACKAGING

Please save the box and all of the packaging in which your C 588 arrived. Should you move or need to transport your C 588, this is the safest container in which to do so. We've seen too many otherwise perfect components damaged in transit for lack of a proper shipping carton so, please: Save that box!

IDENTIFICATION OF CONTROLS

ENGLISH

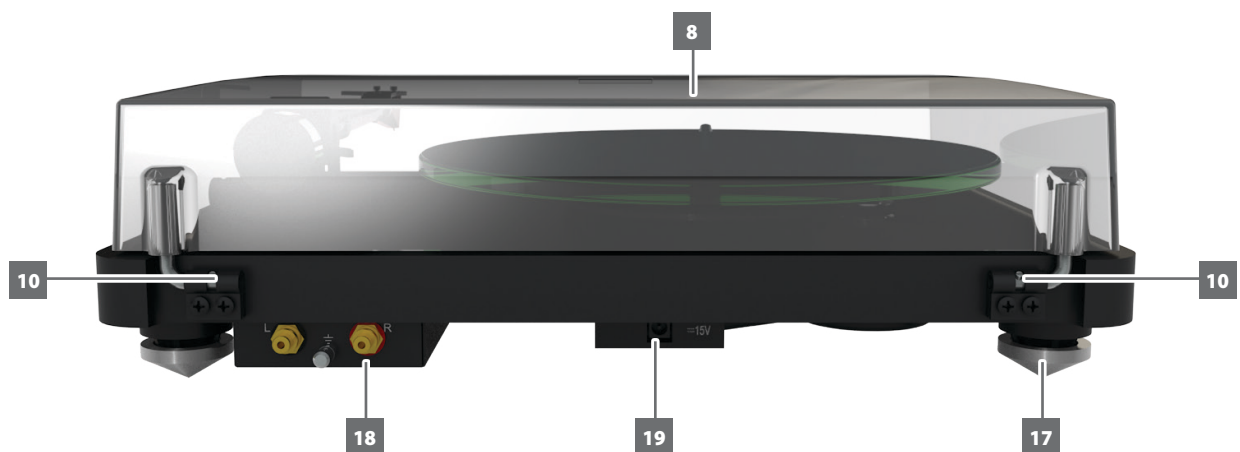

- | | | |
|-----------------|--|---------------------------------|
| 1 Platter | 8 Dustcover | 15 Anti-Skating Adjustment |
| 2 Felt Mat | 9 Dustcover Hinges | 16 Headshell With Finger Lift |
| 3 Sub-Platter | 10 Hinge Fasteners | 17 Damped Feet |
| 4 Motor Pulley | 11 Counterweight | 18 RCA Output, Earth Connection |
| 5 Drive Belt | 12 Tonearm | 19 Power Supply Socket |
| 6 Plinth | 13 Tonearm Lift | |
| 7 On/Off Switch | 14 Tonearm Rest And Removable Transport Lock | |

PLATTER, SUB-PLATTER, FELT MAT AND DRIVE BELT INSTALLATION

- 1 Install sub-platter (3) and drive belt (5).



- 2 Install the platter (1) on the sub-platter (3) and put the felt mat (2) on top of the platter.

ADJUSTING THE PULLEY HEIGHT

- 1 Adjust the pulley height if it taps against the platter.
- 2 Carefully remove platter and drive belt from the turntable.
- 3 Loosen the small screw and move the pulley (4) to the desired position by using a small flathead screwdriver.



- 4 Tighten the screw back and fit the drive belt and the platter.

CARTRIDGE INSTALLATION

IMPORTANT NOTE

This has already been done for you if you purchased this turntable in a package that included the cartridge.

- 1 Install the cartridge into the aluminium headshell using the appropriate hardware included with your cartridge.
- 2 Connect the cartridge as indicated below
 - White : left channel L+
 - Red : right channel R+
 - Green : right channel R-
 - Blue : left channel L-
- 3 For correct cartridge alignment, use the supplied paper cartridge alignment tool with two null points. Consult with your dealer if you are not familiar with two-point setup.

VERTICAL TRACKING FORCE SETTING (VTF)

- 1 Confirm the exact weight of your cartridge before setting the Vertical Tracking Force (VTF).
- 2 Push the counterweight carefully towards the rear end of the counterweight support rod. Place the stylus pressure gauge onto the platter.
- 3 Set the required VTF by lowering the tonearm lift lever. Place the tip of the stylus exactly in between the two points marked 15mN and 20mN.
- 4 Correct pressure has been achieved if the stylus pressure gauge becomes level. The stylus pressure gauge will either not move or tilt down if there is insufficient or excessive pressure.

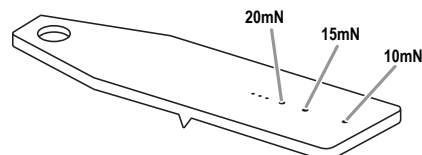

- 5 Adjust the amount of pressure by carefully moving the counterweight (11) along the support rod until the stylus pressure is sufficient to raise the pressure gauge to the level position. Moving the counterweight (11) away from the cartridge will reduce pressure and towards will increase pressure.



- 6 Secure the counterweight (11) using hexagonal key provided.

TONEARM OUTPUT CONNECTION

- 1 Connect the supplied audio cable connector (RCA-to-RCA lead) to the RCA tonearm output located at the rear of the turntable, behind the tonearm.
- 2 Connect the grounding cable on the earth connection screw.

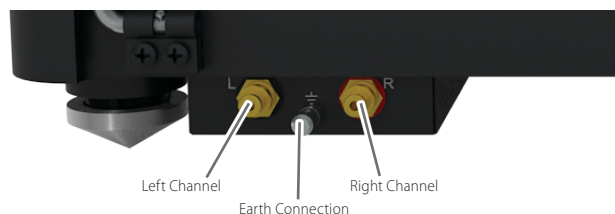

If your amplifier does not have an input suitable for phono cartridges you will require a separate phono amplifier stage for MM or MC cartridges which is then connected between the record player and a free line level input of the amplifier.

VERTICAL TRACKING ANGLE SETTING (VTA)

- 1 Set the Vertical Tracking Angle (VTA) by putting a record on the platter.
- 2 When the needle is lowered into the record groove, the tube of the tonearm should be parallel to the surface of the record. If it is not, loosen both hexagonal screws in the tonearm base just enough to allow vertical movement of the arm pillar without force, and slide the arm up or down until it is parallel.

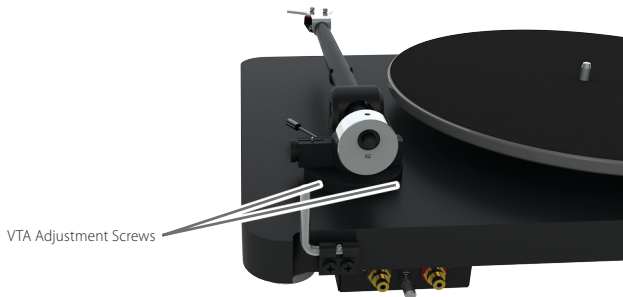

- 3 Carefully and evenly retighten the hexagon screws **without applying excessive force** (which could deform the arm pillar).

AZIMUTH SETTING

The cartridge needle must be perpendicular to the record in order to trace the groove wall modulations correctly. The azimuth (angle) is precisely set by the factory. In the event that you need to modify this setting, however, follow the instructions below.

- 1 Use the 1.5 mm hexagonal key to loosen up the small AZIMUTH SET SCREW.

IMPORTANT NOTE

Do not completely remove the azimuth set screw!

- 2 Loosen the screw just enough to gently rotate the arm tube and set the azimuth to the correct position. The correct position can be checked from the front view, preferably with the needle placed on a mirror placed on the platter.



- 3 Once the azimuth setting is correct, gently re-tighten the AZIMUTH SETTING SCREW.

ANTI-SKATING FORCE ADJUSTMENT

The anti-skating force must be adjusted to the corresponding tracking force. The anti-skating mechanism is calibrated from 0 to 5g.

Three examples of magnetic anti-skating mechanism:

Tracking force – 1.5g; Anti-skating force 1.5g

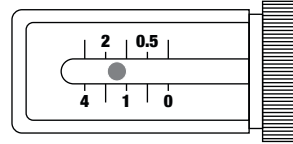

Tracking force – 1.7g; Anti-skating force 1.7g

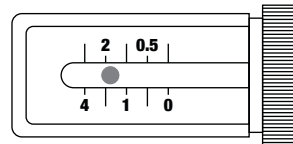

Tracking force – 2.3g; Anti-skating force 2.3g

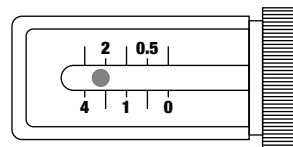

CONTROLLING THE TURNTABLE

- 1 Press the button ON/OFF switch (7) to start rotation of the platter.
- 2 Play 45 r.p.m by putting the drive belt (5) over the larger diameter part of the motor pulley using accessory toll provided.
- 3 Play 33 r.p.m by repeating above but this time using the smaller step on the pulley.

PROBLEM	POSSIBLE CAUSE
<p>The platter doesn't turn although the unit is switched on.</p>	<ul style="list-style-type: none"> • The unit is not connected to the mains power supply. • No mains power is being delivered at the socket. • The drive belt is not fitted properly or has slipped off.
<p>One or both channels have no output signal.</p>	<ul style="list-style-type: none"> • No signal contact from the cartridge to any of the following - internal tonearm wiring, arm lead, phono box; or to the amplifier. • Faulty plug, broken wire or loose solder joint in the plug/socket connection. • Phono input not selected at amplifier. • Amplifier or speakers are defective or muted. • No connection to the loudspeakers. • Amplifier not switched on.
<p>There is strong hum on phono input.</p>	<ul style="list-style-type: none"> • No ground connection from cartridge, arm or arm cable to amplifier or ground loop.
<p>Sound is distorted or inconsistent from one or both channels.</p>	<ul style="list-style-type: none"> • Turntable is connected to wrong input of amplifier or MM/MC switch is incorrectly set. • Needle or cantilever is damaged. • Wrong rpm setting. • Drive belt is overstretched or dirty. • Platter bearing needs lubrication, dirty or damaged.

SPECIFICATIONS

GENERAL SPECIFICATIONS

TURNTABLE

Nominal speed	33/45 rpm, manual speed change (78 rpm possible with special pulley)
Speed variance	33rpm: < ± 0.35 %, 45rpm: < ± 0.30 %
Wow and flutter	33rpm: < ± 0.12 %, 45rpm: < ± 0.11 %
Signal to noise	-70 dB
Downforce range	0 - 30 mN 0 - 3.0 grams
Supplied counterweight system	Counterweight for cartridges: 6 - 13 g
Voltage	Universal switch mode power supply: 15 V DC/0.8 A, 100-240 V AC, 47 - 63Hz
Power consumption	5 W maximum 0.3W standby mode

TONARM

Effective tonearm mass	9.5 g
Effective tonearm length	230 mm
Overhang	18 mm

ORTOFON OM 10 CARTRIDGE

Frequency range	20 Hz - 22 kHz
Channel separation	22dB/1kHz
Output voltage	5.5 mV
Recommended load impedance	47 kohms
Amplifier connection	MM-input
Compliance/stylus type	20µm/mN – elliptical
Recommended tracking force	18mN
Weight	7.2g

DIMENSION AND WEIGHT

Gross dimensions (W x H x D)	435 x 340 x 125mm 17 1/8 x 13 3/16 x 4 15/16 inches
Shipping weight	9.2 kg (20.3 lbs)

Specifications are subject to change without notice. For updated documentation and features, please check out www.NADelectronics.com for the latest information about C 588.



www.NADelectronics.com

**©2019 NAD ELECTRONICS INTERNATIONAL
A DIVISION OF LENBROOK INDUSTRIES LIMITED**

All rights reserved. NAD and the NAD logo are trademarks of NAD Electronics International, a division of Lenbrook Industries Limited.
No part of this publication may be reproduced, stored or transmitted in any form without the written permission of NAD Electronics International.
While every effort has been made to ensure the contents are accurate at the time of publication, features and specifications may be subject to change without prior notice.

C588_ENG_OM_V02 - JAN 2019

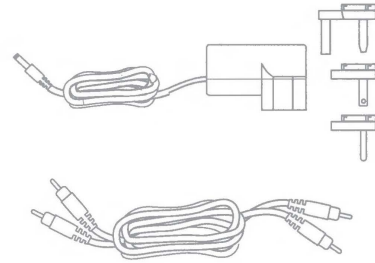
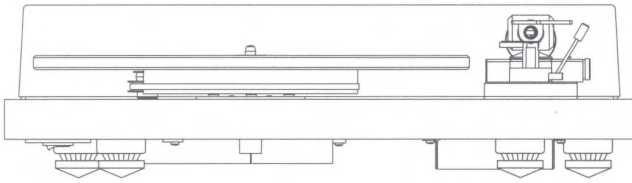

<https://nadelectronics.com/product/c-588-turntable/>

1.

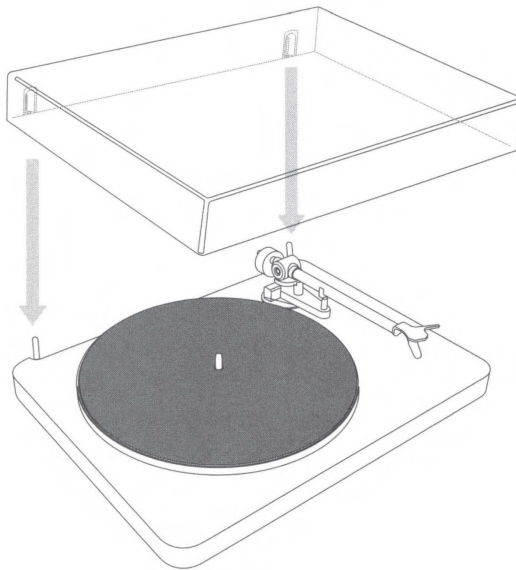
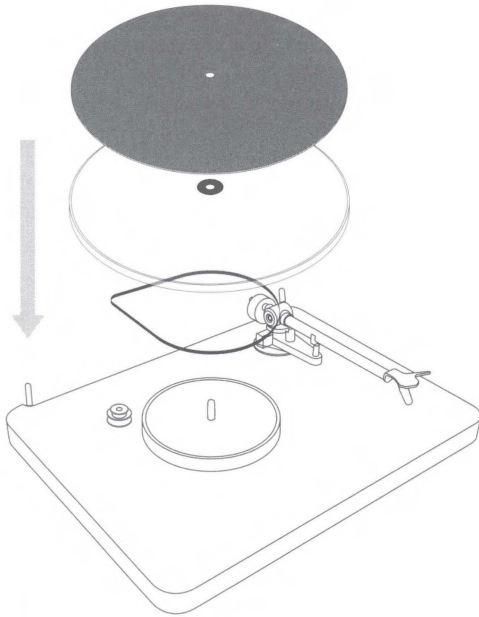

2.

3.

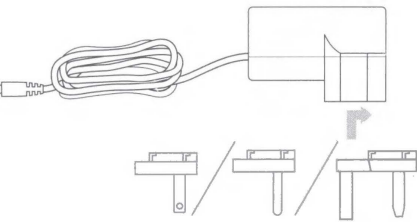
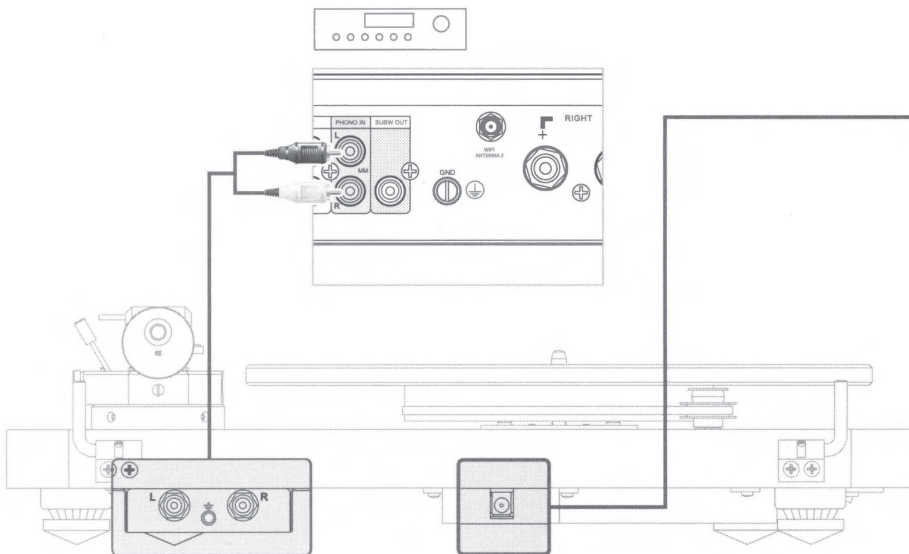

4.

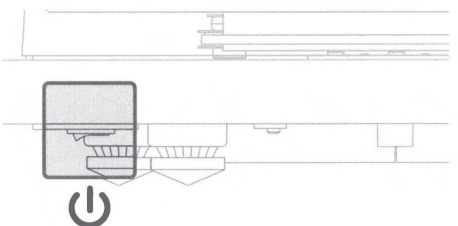

TWO-POINT CARTRIDGE ALIGNMENT PROTRACTOR

