

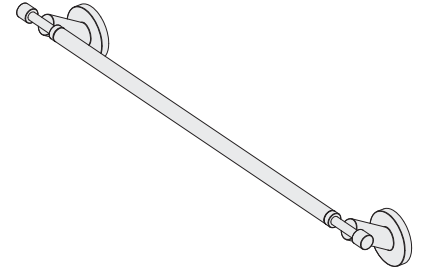

SYMMONS® Sereno™

24 inch Towel Bar 433TB-24

Specification Submittal



Model Numbers

- 433TB-24 24 inch Towel Bar

Feature Highlights

- Metal construction
- Standard finish is polished chrome

Finish Options

Append appropriate -suffix to model number.

- STN Satin nickel finish
- Polished chrome finish (standard finish)

Warranty

- Limited Lifetime - to the original end purchaser in residential/consumer installations.
- 5 years - for commercial installations

Dimensions Sereno Towel Bar, 433TB-24

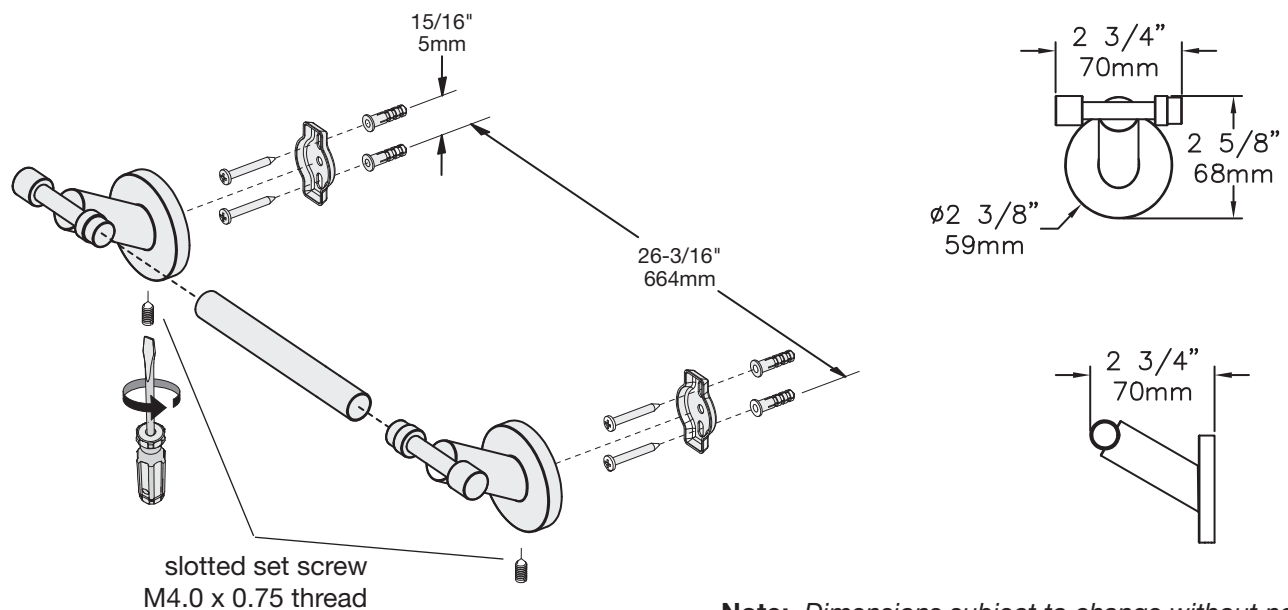

Note: Dimensions subject to change without notice.

Symmons Industries, Inc. ■ 31 Brooks Drive ■ Braintree, MA 02184
 (800) 796-6667, (781) 848-2250 ■ Fax (800) 961-9621, (781) 843-3849
 Website: www.symmons.com ■ Email: customerservice@symmons.com

©2008 Symmons Industries, Inc. Printed in U.S.A. ■ 101008



SYMMONS®
the smart choice™