

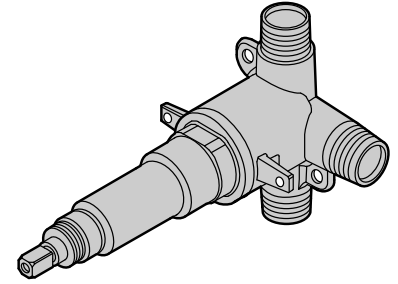





Location:

**2DIV-BODY**  
Dual Outlet Diverter Valve  
**Specification Submittal**



<p><b>Model Numbers</b></p> <p><input type="checkbox"/> <b>2DIV-BODY</b> <i>Dual Outlet Diverter Valve</i></p>	<p><b>Specification</b></p> <p>Dual outlet diverter valve features shared functionality. Inlet and outlet connections are both 1/2" male IPS &amp; 1/2" female sweat. Components made from lead free metal construction.</p> <div style="text-align: right;">   </div>
<p><b>Compliance</b></p> <p>-ASME A112.18.1/CSA B125.1</p> <div style="text-align: center;">  </div>	<p><b>Warranty</b></p> <p><b>Limited Lifetime</b> - to the original end purchaser in consumer/residential installations.  <b>5 Years</b> - for industrial/commercial installations.  Refer to <a href="http://www.symmons.com/warranty">www.symmons.com/warranty</a> for complete warranty information.</p>

**Dimensions**

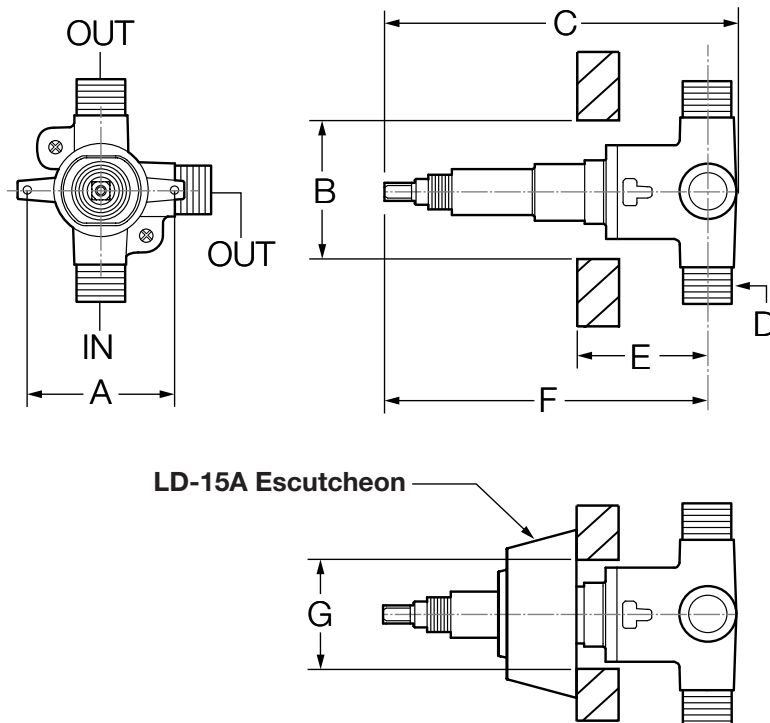

Measurements	
A	2 5/8", 67 mm
B	Hole Size Min. Ø 3", 76 mm Max. Ø 3 1/4", 83 mm
C	5 3/4", 146 mm
D	(3x) 1/2" male IPS & (3x) 1/2" female sweat
E	See note 1
F	5 3/8", 137 mm
G	Hole Size Min. Ø 1 3/4", 44 mm Max. Ø 1 7/8", 48 mm <b>LD-15A Escutcheon:</b> 2DIV Temptrol Temptrol II Temptrol Commercial Temptrol Deluxe Safetymix Visu-Temp

**Notes:**

- Figure is determined by style of trim attached to shower valve. See rough-in dimension drawing for shower valve application with diverter valve.
- Dimensions subject to change without notice.





Emplacement:

2DIV-BODY  
Inverseur de sortie double

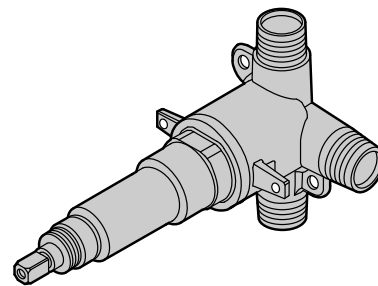
## Présentation des spécifications



<p><b>Numéro de modèle</b></p> <p><input type="checkbox"/> <b>2DIV-BODY</b> <i>Inverseur de sortie double</i></p>	<p><b>Spécification</b></p> <p>L'inverseur de sortie double présente des fonctionnalités partagées et comporte des crans précis. Les raccords d'entrée et de sortie sont un IPS mâle de 1/2 po et un femelle de 1/2 po soudé à l'étain. Les composants sont fabriqués de métal sans plomb.</p>  
<p><b>Conforme</b></p> <p>-ASME A112.18.1/CSA B125.1</p> 	<p><b>Garantie</b></p> <p><b>À vie limitée</b> - à l'acheteur original dans les installations du consommateur ou résidentielles. <b>5 ans</b> - pour des installations commerciales et industrielles. Se reporter au site <a href="http://www.symmons.com/warranty">www.symmons.com/warranty</a> (en anglais) pour l'information complète concernant la garantie.</p>

## Dimensions

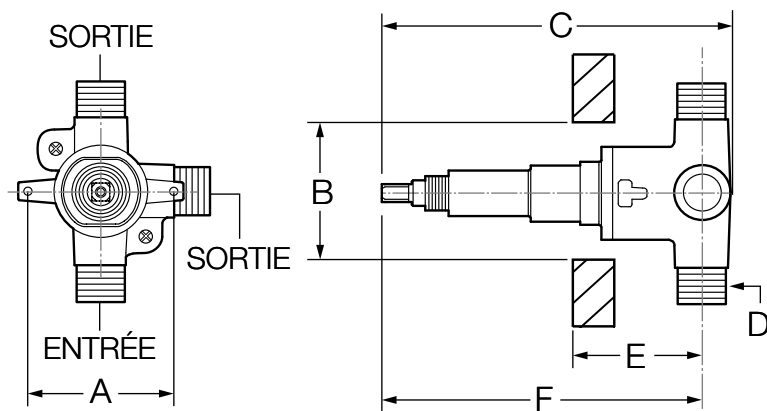

LD-15A Rosace de douche

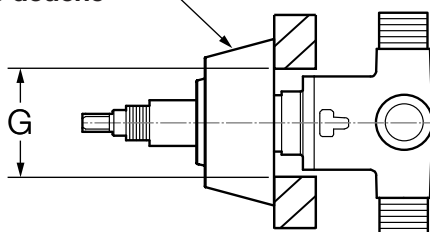

Mesures	
A	2 5/8 po, 67 mm
B	Taille du trou Min. Ø 3 po, 76 mm Max. Ø 3 1/4 po, 83 mm
C	5 3/4 po, 146 mm
D	(3x) Raccord IPS mâle de 1/2 po et (3X) raccord femelle soudé à l'étain de 1/2 po
E	Voir la remarque 1
F	5 3/8 po, 137 mm
G	Taille du trou Min. Ø 1 3/4", 44 mm Max. Ø 1 7/8", 48 mm <b>Rosace LD-15A:</b> 2DIV Temptrol Temptrol II Temptrol Commercial Temptrol Deluxe Safetymix Visu-Temp

### Remarques :

- 1) La figure est déterminée par le style de garniture attaché à la vanne de douche. Voir le dessin de côté de la robinetterie brute pour le fonctionnement d'une soupape de douche avec inverseur.
- 2) Les dimensions sont sujettes à changer sans préavis.