

PARTS LIST / LISTE DES PIÈCES / LISTA DE PIEZAS
ITEM NO. / ARTICLE NO. / ARTICULO NO. : 21308
DESCRIPTION / DESCRIPCIÓN : CURIO / VITRINE / VITRINA

⚠ WARNING



Serious or fatal crushing injuries can occur from furniture tip-over. To help prevent tip-over:

- install tipover restraint provided.
- Place heaviest items in the lowest drawers.
- Do not set TV's or other heavy objects on top of this product unless the product is specifically designed to accommodate them.
- Never allow children to climb or hang on drawers, doors, or shelves.
- Never open more than one drawers at a time (OR)
- Do not defeat or remove the drawers interlock system.

Use of tip-over restraints may only reduce, but not eliminate, the risk of tip-over. this is a permanent label. Do not remove!

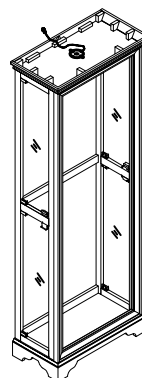
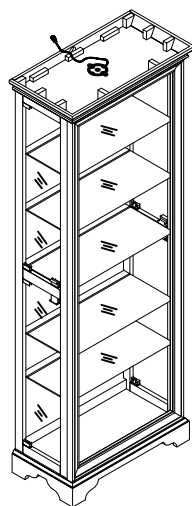

A

- x1 Curio
- x1 Vitrine
- x1 Vitrina

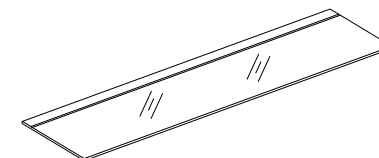

B

- x5 Glass shelf *
- x5 Étagère en verre
- x5 Estante de vidrio



C

- x18 Common Shelf Support *
- x18 Supports Pour Tablette
- x18 Soporte De Las Repisas



D

- x1 Furniture Tipping Restraint
- x1 Systeme antibasculement
- x1 Control para evitar vulcos

* Replaceable Part

▲ WARNING

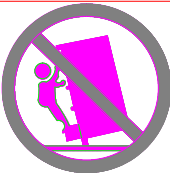

Serious or fatal crushing injuries can occur from furniture tip-over. To help prevent tip-over:

- install tipover restraint provided.
- Place heaviest items in the lowest drawers.
- Do not set TV's or other heavy objects on top of this product unless the product is specifically designed to accommodate them.
- Never allow children to climb or hang on drawers, doors, or shelves.
- Never open more than one drawers at a time (OR)
- Do not defeat or remove the drawers interlock system.

Use of tip-over restraints may only reduce, but not eliminate, the risk of tip-over. this is a permanent label. Do not remove!

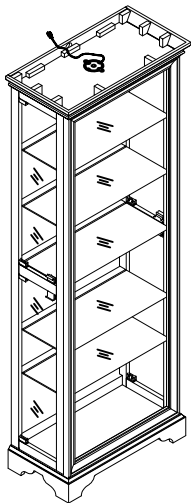

Door pull
 Poignée de tirage
 Manilla para tirar

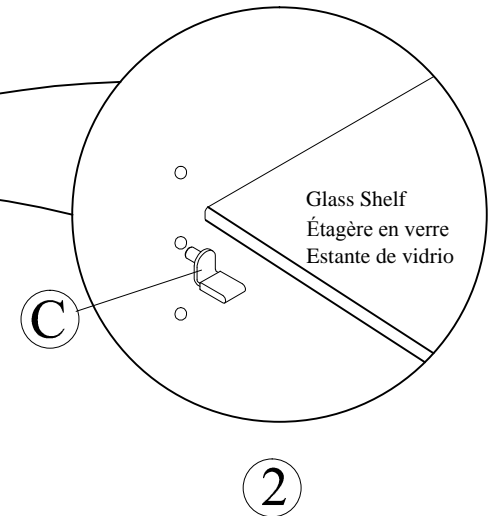
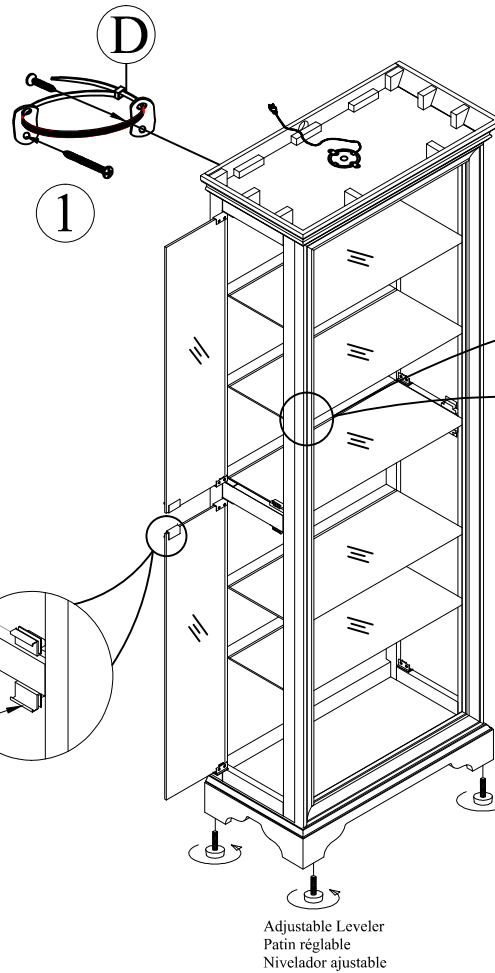



REPLACEABLE PART / PARTIE REMPLACABLE / PARTE REEMPLAZABLE
 ITEM NO . / ARTICLE NO. / ARTICULO NO. : 21308
 DESCRIPTION / DESCRIPCIÓN : CURIO / VITRINE / VITRINA

WARNING

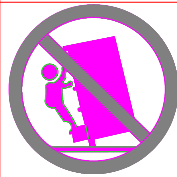

Serious or fatal crushing injuries can occur from furniture tip-over. To help prevent tip-over:

- install tipover restraint provided.
- Place heaviest items in the lowest drawers.
- Do not set TV's or other heavy objects on top of this product unless the product is specifically designed to accommodate them.
- Never allow children to climb or hang on drawers, doors, or shelves.
- Never open more than one drawers at a time (OR)
- Do not defeat or remove the drawers interlock system.

Use of tip-over restraints may only reduce, but not eliminate, the risk of tip-over.
 this is a permanent label. Do not remove!

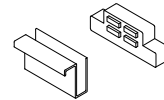

x4 RC-PULL-02
 Glass Door Pull (Brass) with Felt *
 Poignée (Laiton) et Feutre
 Tirador (Latón) y Fieltro

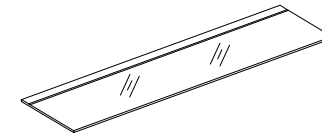

x5 R21307-61 *
 Glass shelf *
 Étagère en verre
 Estante de vidrio

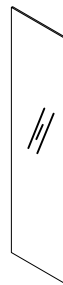
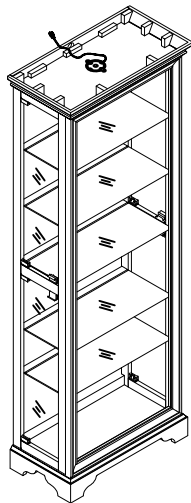

x4 R21307-60
 Door Glass
 Porte en verre
 Puerta de vidrio



x18 RC-SUPPORT-01
 Common Shelf Support *
 Supports Pour Tablette
 Soporte De Las Repisas

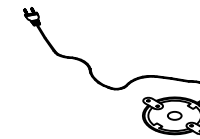

x1 RC-LIGHT-01
 Light fixture w/roll switch*
 lumière et interrupteur
 luz y interruptor

* Replaceable Part