

**homestyles**

2000-10-FB80

# Chair

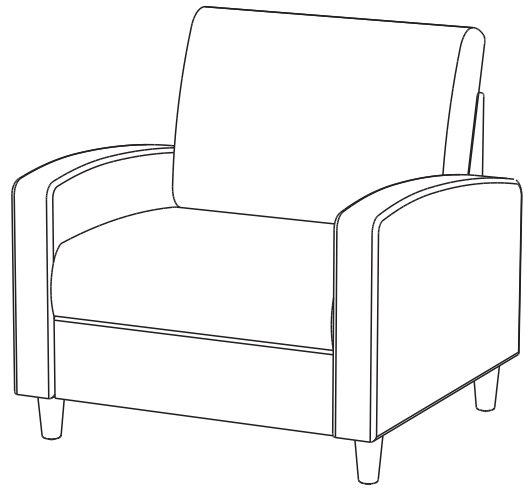

## IMPORTANT

Carefully remove all the parts from the carton and place them individually on a soft cloth to prevent scratches or other damage.

Carefully and strictly follow these assembly instructions to ensure a completed product as designed.

Do not use power tools above 8 volts to assemble.

## Part List

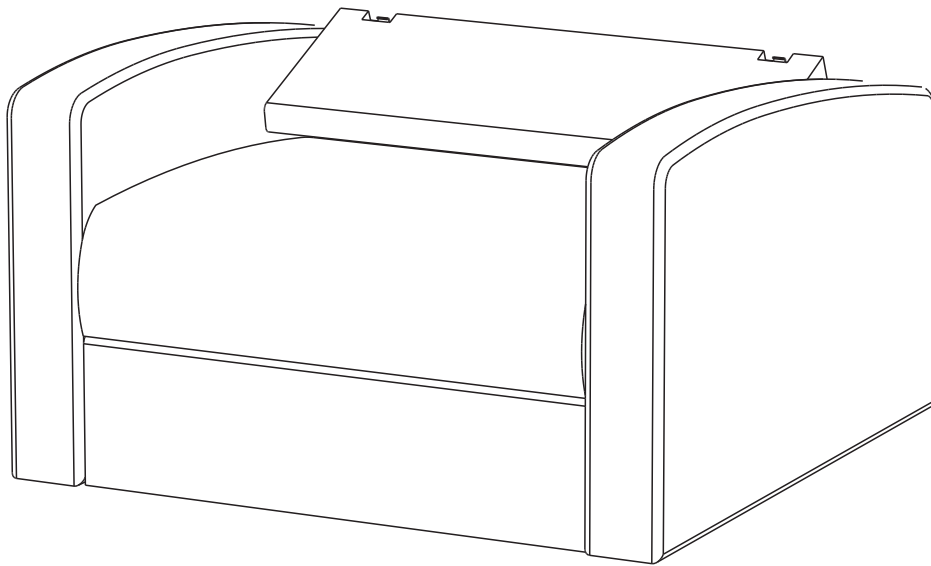

A.  
Base  
1 pc.

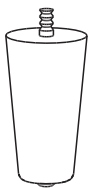

B.  
Foot  
4 pcs.

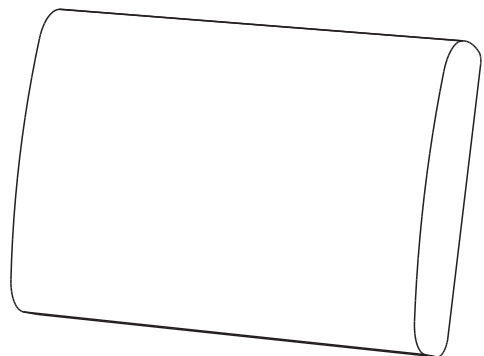

C.  
Back Cushion  
1 pc.

## Assembly Instructions 2/3

### IMPORTANT

- Use a soft cloth between these parts and the floor.

### STEP 1

Open zipper at bottom of Base (A), remove Feet (B), then close zipper. (See Figure 1)

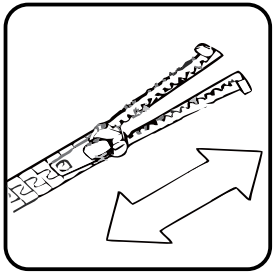
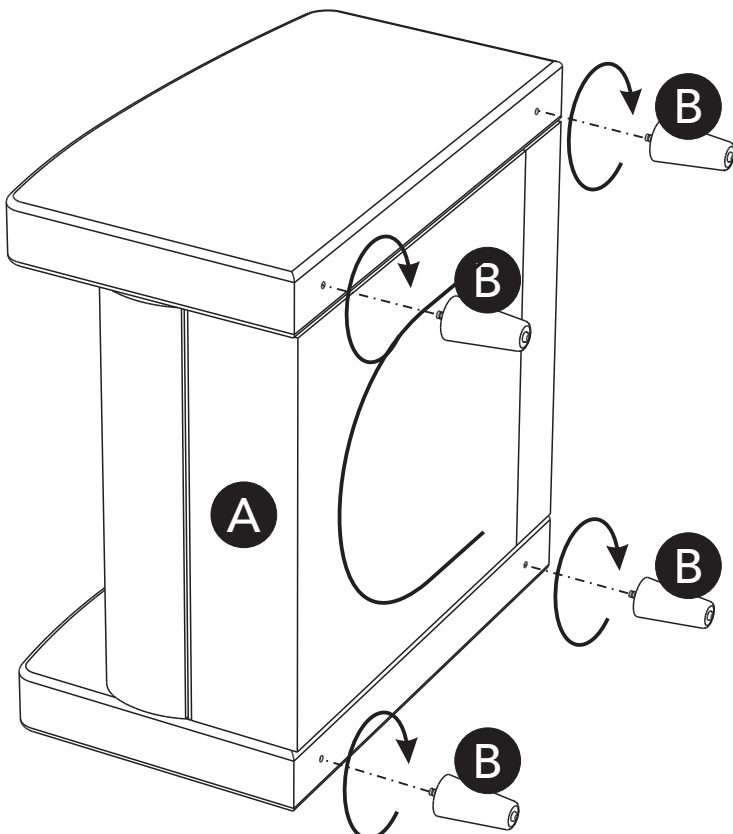
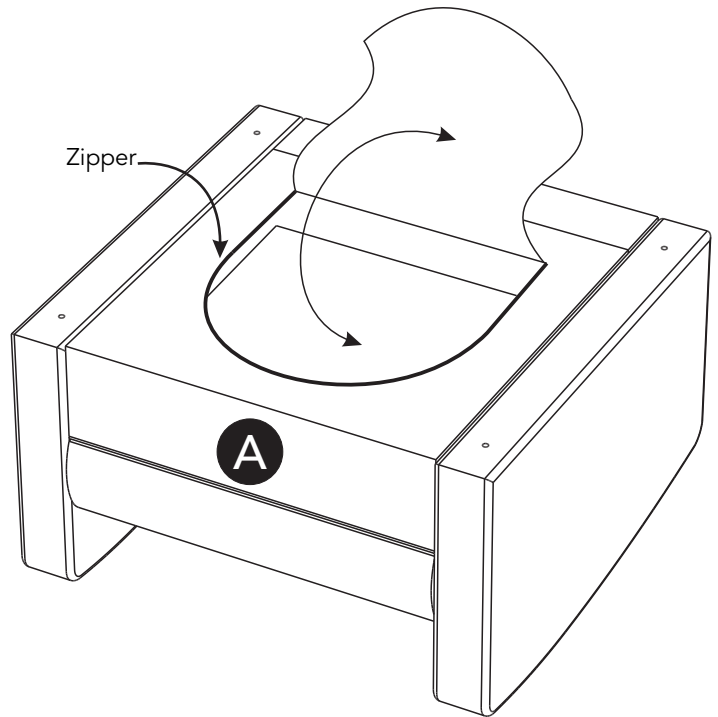

Figure 1



### STEP 2

Attach Feet (B) to Base (A), then tighten.

## Assembly Instructions 3/3

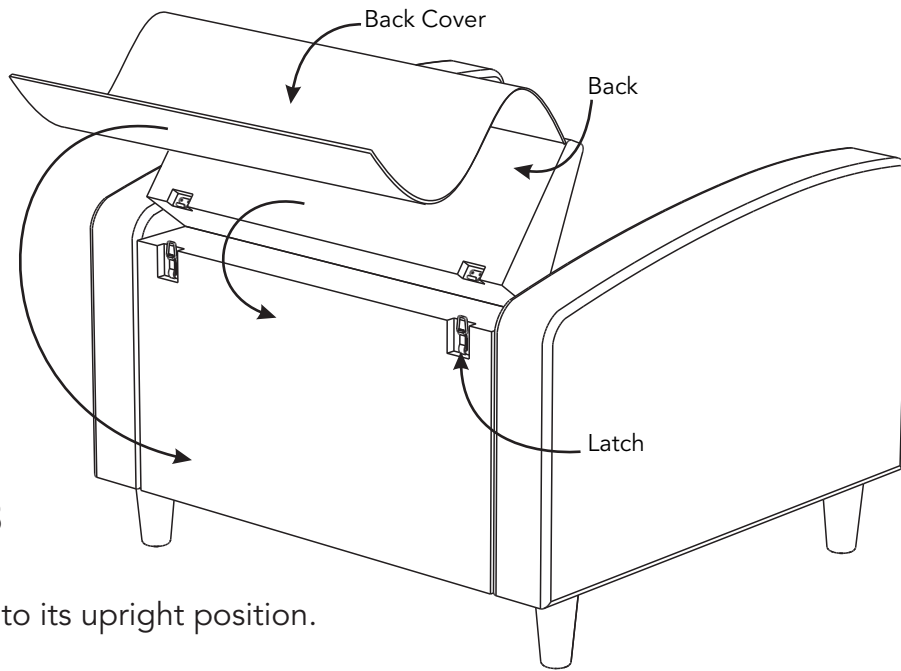

### STEP 3

Turn unit to its upright position.

Rotate back into position.

Lock back in position with latches. (See Figure 2)

Attach back cover to back of unit. (See Figure 3)

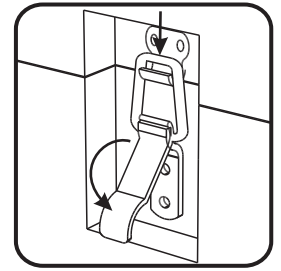

Figure 2

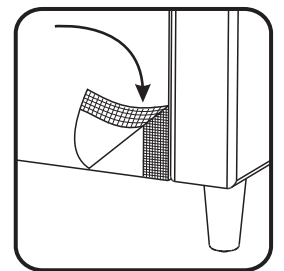
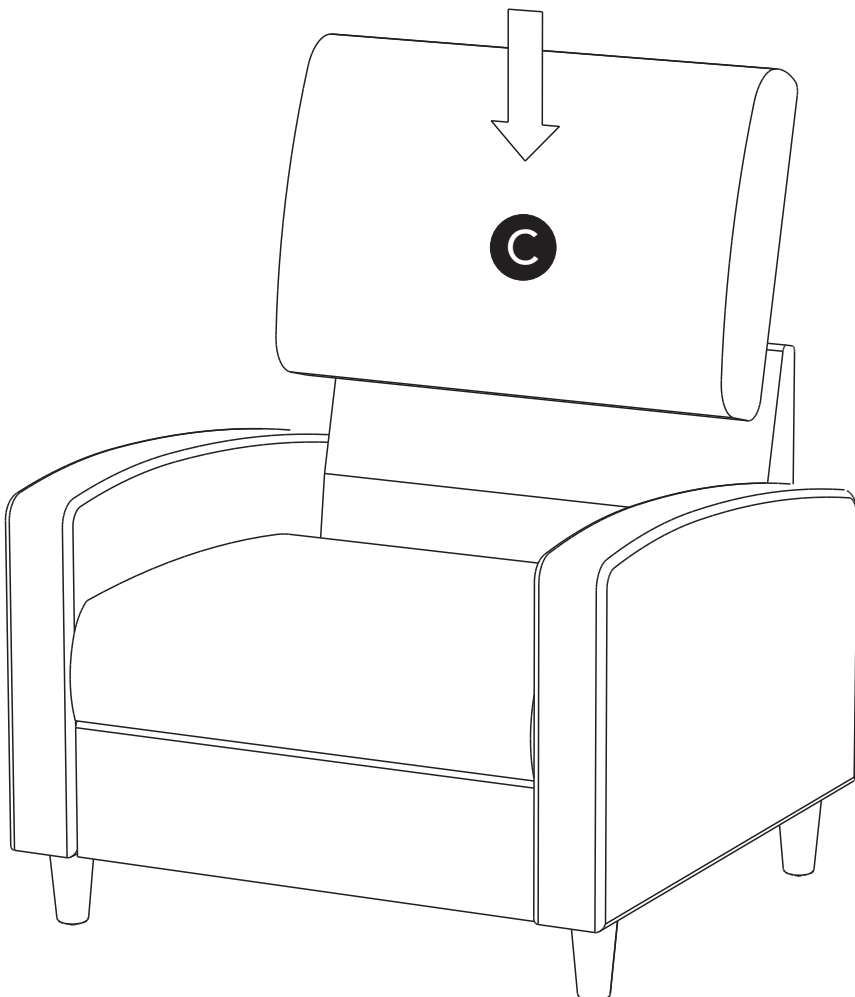

Figure 3



### STEP 4

Place Back Cushion (C) into position.

# CARE INSTRUCTIONS

## NEVER

allow liquids to remain on furniture.  
Absorption causes parts to warp  
and split and finishes to delaminate.

## NEVER

use glass cleaners on  
finished furniture. Ammonia  
chemically attacks the finish.



Do not use power tools  
above 8 volts to assemble.

**PREVENT  
CRACKING**

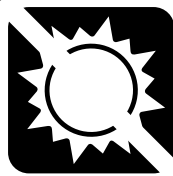

Do not place  
in direct sunlight.

**PREVENT  
FADING**



Do not write  
directly on surface.

**PREVENT  
MARKING**



Do not place hot  
objects on surface.

**PREVENT  
FINISH DAMAGE**

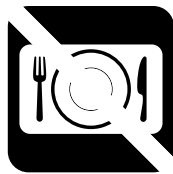

Do not use rubber  
based placemats.

**PREVENT  
DISCOLORING**



Do not use commercial  
waxes and polishes.

**PREVENT  
YELLOWING**

## CLEAN

with a soft cloth moistened  
in lukewarm soap and water.  
Buff with a dry clean cloth.



**homestyles** will provide replacements free of charge for missing or damaged parts within 1 year of purchase. Digital images of the defective parts may be required. If the product was not purchased from an authorized retailer, **homestyles** is under no obligation to provide replacement parts. Parts are not available for fully assembled items nor are parts available for sale. Replacements for missing or damaged parts may be requested via contact info below.

**homestyles** Customer Service: [www.homestylesfurniture.com](http://www.homestylesfurniture.com),  
[servicedesk@homestylesfurniture.com](mailto:servicedesk@homestylesfurniture.com), 888-680-7460