

**WARNING**

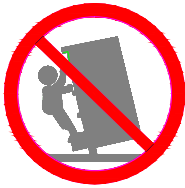

Children have died from furniture tip-over. To reduce the risk of furniture tip-over :

- ALWAYS install tipover restraint provided.
- NEVER put a TV on this product.
- NEVER allow children to stand, climb or hang on drawers, doors, or shelves.
- NEVER open more than one drawer at a time.
- Place heaviest items in the lowest drawers.



*This is a permanent label.  
Do not remove !*

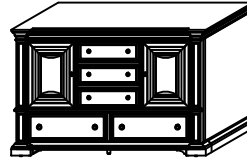
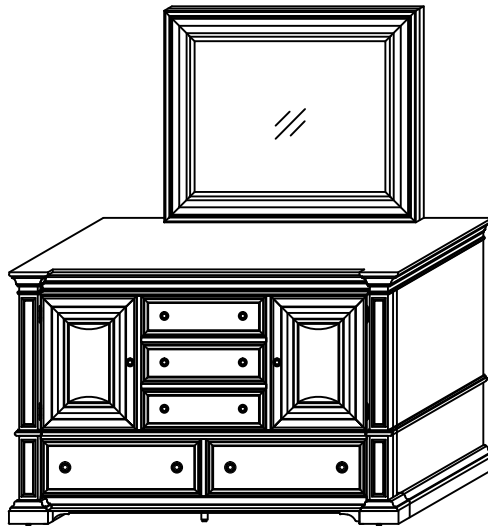

**A**

- x1 Dresser
- x1 Commode
- x1 Tocador

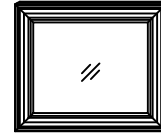

**B**

- x1 Mirror
- x1 Miroir
- x1 Espejo



**C**

- x2 Mirror Support \*
- x2 Supporte de miroir
- x2 Soporte del espejo

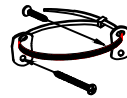

**D**

- x1 Anti-tipping Restraint \*
- x1 Systeme antibasculement
- x1 Control para evitar vulcos



**E**

- x8 Allen Bolt Ø1/4" x 38mm \*
- x8 Vis à tête creuse hexagonale Ø1/4 " x 38mm
- x8 Perno Allen Ø1/4 " x 38mm



**F**

- x8 Lock Washer Ø1/4" \*
- x8 Rondelle de blocage Ø1/4 "
- x8 Arandela de seguridad Ø1/4 "



**G**

- x8 Flat Washer Ø1/4" \*
- x8 Rondelle de plate Ø1/4 "
- x8 Arandela plana Ø1/4 "

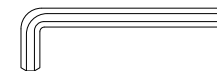

**H**

- x1 Allen Key 4mm \*
- x1 Clé hexagonale 4mm
- x1 Llave allen 4mm

\* Replaceable Part

**WARNING**

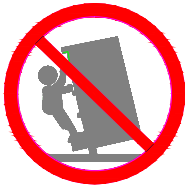

**Children have died from furniture tip-over. To reduce the risk of furniture tip-over :**

- ALWAYS install tipover restraint provided.
- NEVER put a TV on this product.
- NEVER allow children to stand, climb or hang on drawers, doors, or shelves.
- NEVER open more than one drawer at a time.
- Place heaviest items in the lowest drawers.

*This is a permanent label.  
Do not remove !*

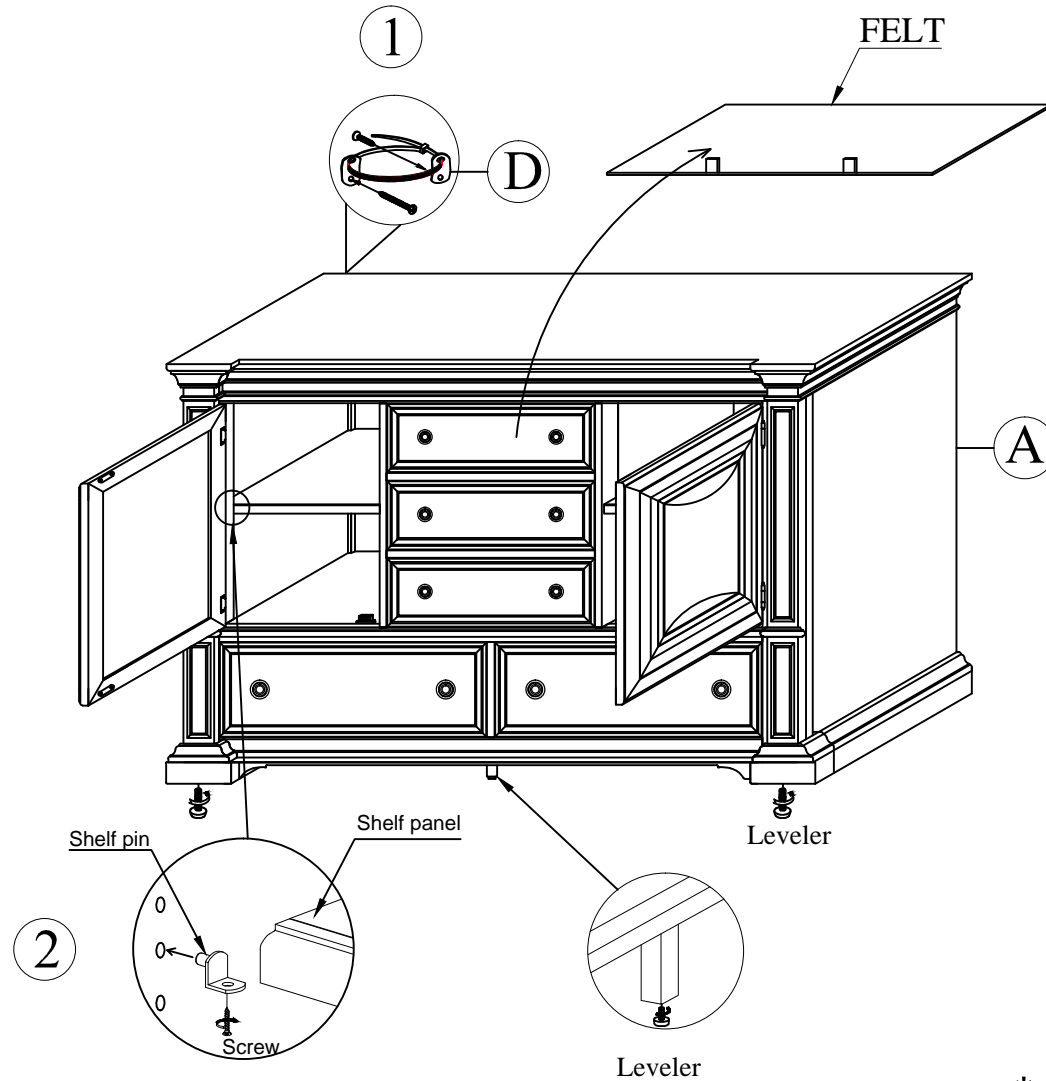
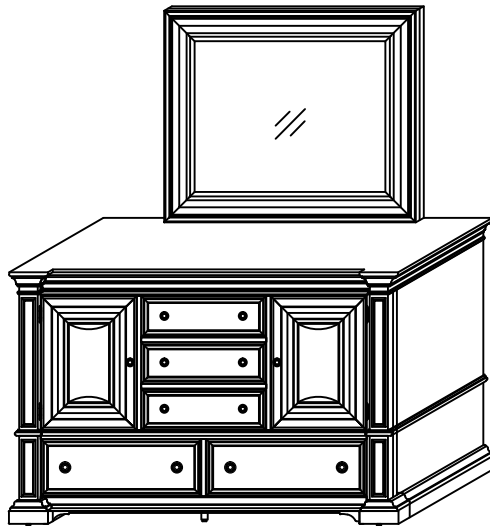

\* Replaceable Part

**WARNING**

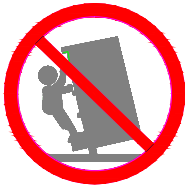

**Children have died from furniture tip-over. To reduce the risk of furniture tip-over :**

- ALWAYS install tipover restraint provided.
- NEVER put a TV on this product.
- NEVER allow children to stand, climb or hang on drawers, doors, or shelves.
- NEVER open more than one drawer at a time.
- Place heaviest items in the lowest drawers.

*This is a permanent label.  
Do not remove !*

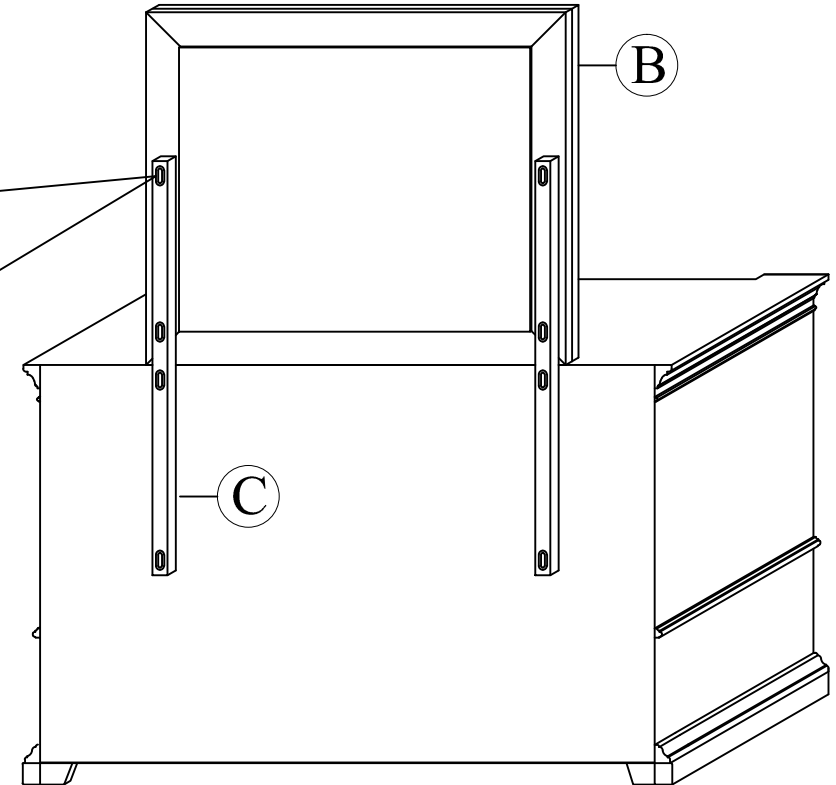
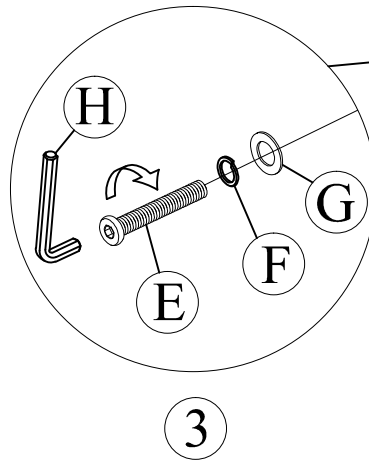
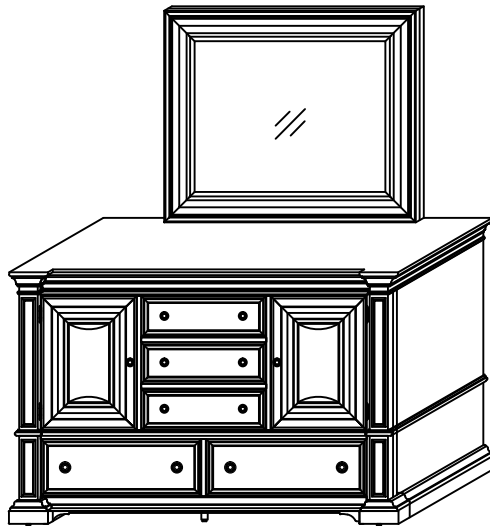
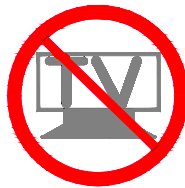

\* Replaceable Part

**WARNING**

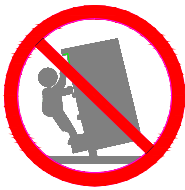

**Children have died from furniture tip-over. To reduce the risk of furniture tip-over :**

- ALWAYS install tipover restraint provided.
- NEVER put a TV on this product.
- NEVER allow children to stand, climb or hang on drawers, doors, or shelves.
- NEVER open more than one drawer at a time.
- Place heaviest items in the lowest drawers.

*This is a permanent label.  
Do not remove !*

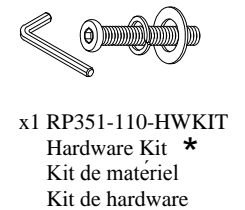
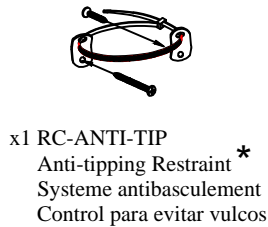
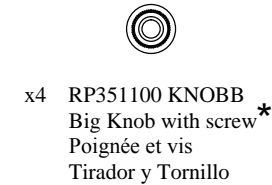
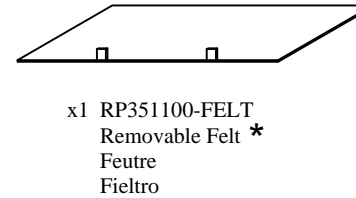
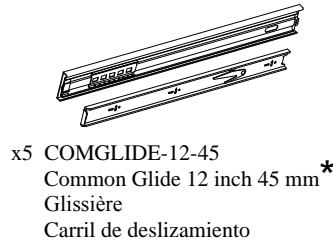
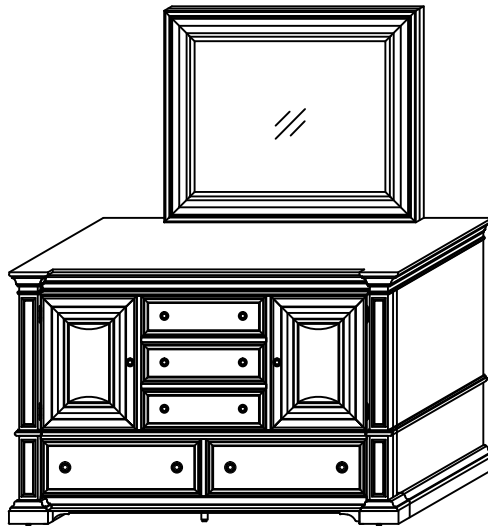

\* Replaceable Part