

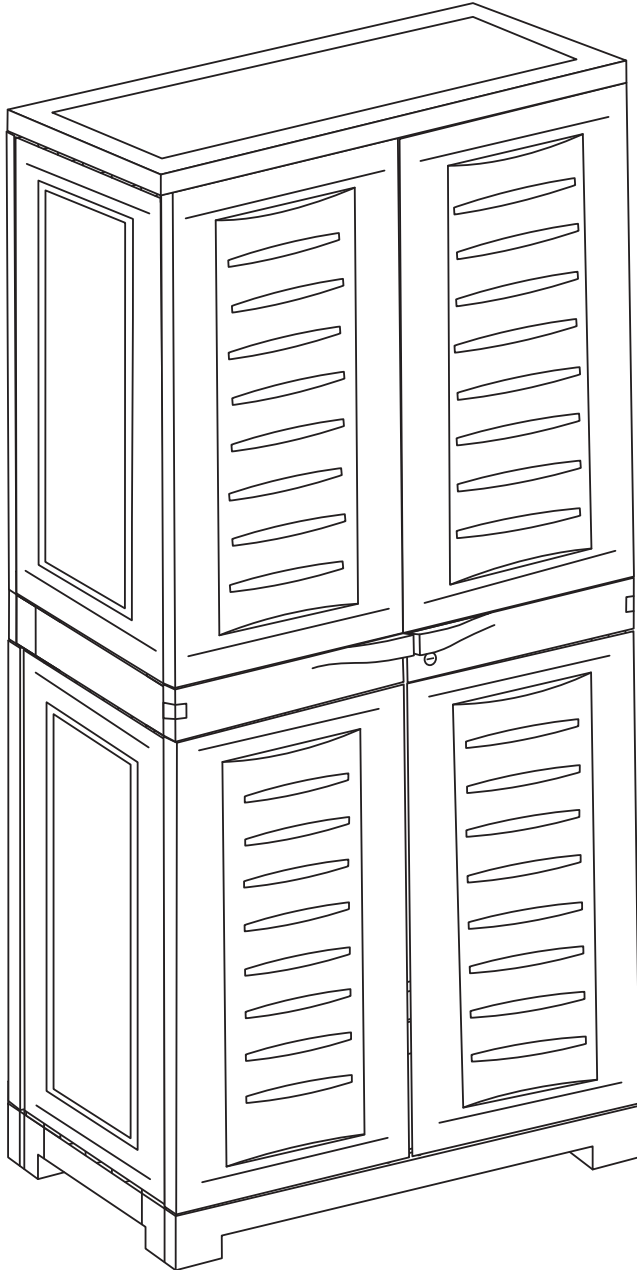

Thank you for choosing Sunnydaze Decor. We stand behind our brand and the quality of the items we sell. Replacement parts or products will be sent at our discretion within the 1-year warranty period. Proof of purchase, with the date of purchase as well as photos of the merchandise defect, must be provided. Photos are used to determine the cause of defects and for future quality control. Register your warranty at <https://tiny.cc/SunnydazeWarranty>. If you have any questions, comments or concerns, feel free to contact us by phone at 833-982-1977, by email: customerservice@sunnydazedecor.com, or via our contact us page at <https://tiny.cc/SunnydazeContact>





LOCKABLE STORAGE CABINET WITH 3 ADJUSTABLE SHELVES

SUP-301

Review all assembly and care information before using this product. Save this manual for future reference.
Assemble components on a soft, clean surface to avoid damaging the finish.

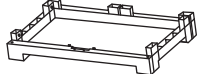

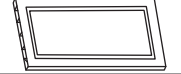
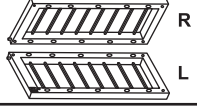
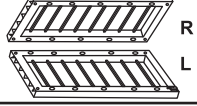
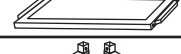
 **Inspect packaging to ensure all parts are accounted for before disposing of packing materials.**
 Save the packing slip.

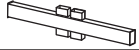
No.	CODE	PARTS		QTY.
1	TP		Top Panel	1
2	BT		Bottom Panel	1
3	SP		Side Panel	4
4	BP		Back Panel	4
5	TD		Top Door (L/R)	2
6	BD		Bottom Door (L/R)	2
7	SL		Shelf	3
8	DH		Door Handle (L/R)	2
9	SPL		Side Panel Link	2
10	BL		Back Panel Link	1

30 pounds
13.6 kg
Weight Capacity per Shelf

 **CAUTION:** Distribute weight evenly throughout this product to avoid tipping.

 **WARNING:**

Manufacturer and seller expressly disclaim any and all liability from personal injury, property damage or loss, whether direct or indirect, or incidental, resulting from the incorrect attachment, improper use, inadequate maintenance, or neglect of this product.

ASSEMBLY

STEP 1

BT: 1
BP: 2

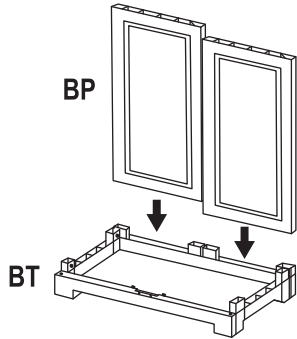

Affix two Back Panels (BP) to the Bottom Panel (BT), as shown.

STEP 2

SP: 2

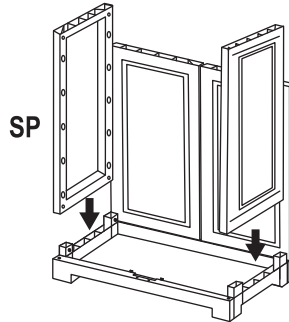

Affix two Side Panels (SP) to the bottom panel, as shown.

STEP 3

BL: 1
SPL: 2

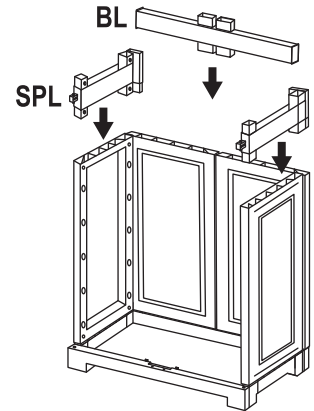

Affix one Back Link (BL) to the back panels.

Ensuring the door hinges are facing the front, affix two Side Links (SPL) to the side panels.

STEP 4

BP: 2

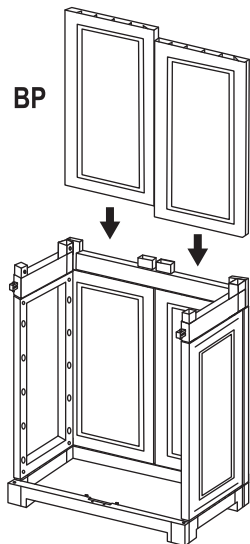

Affix two Back Panels (BP) to the back link.

STEP 5

SP: 2

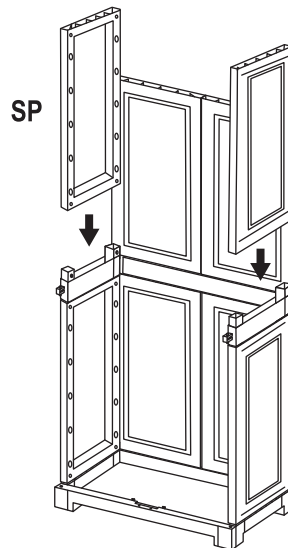

Affix two Side Panels (SP) to the side links.

STEP 6

BD-L: 1
BD-R: 1
DH-L: 1
DH-R: 1
TD-L: 1
TD-R: 1

IMPORTANT:

Before beginning, lay out all components to ensure they are assembled in the correct direction.

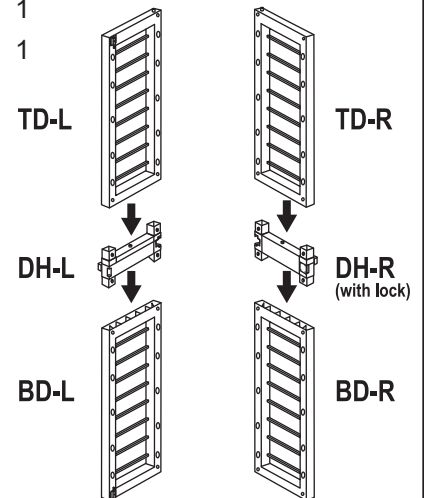

Assemble the doors as shown: Bottom door, door handle, top door.

STEP 7

TP: 1

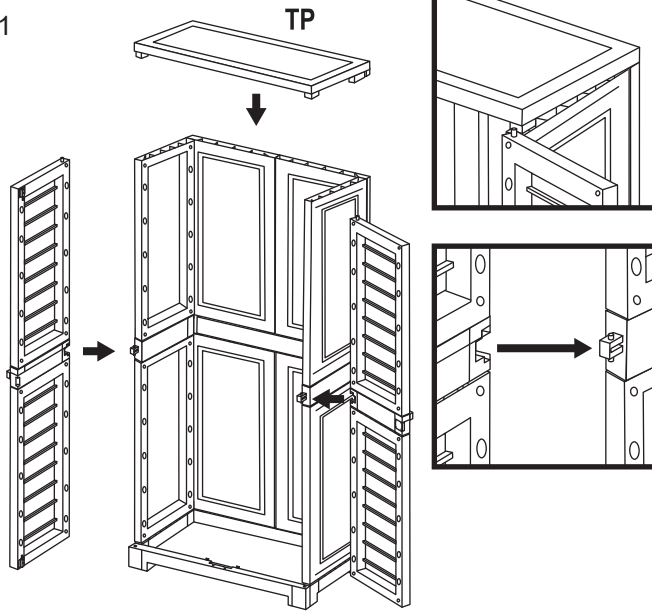

Ensuring the pivot pins on the top doors align with the front of Top Panel (TP), firmly press the top to secure it to the unit.

STEP 8

SL: 3

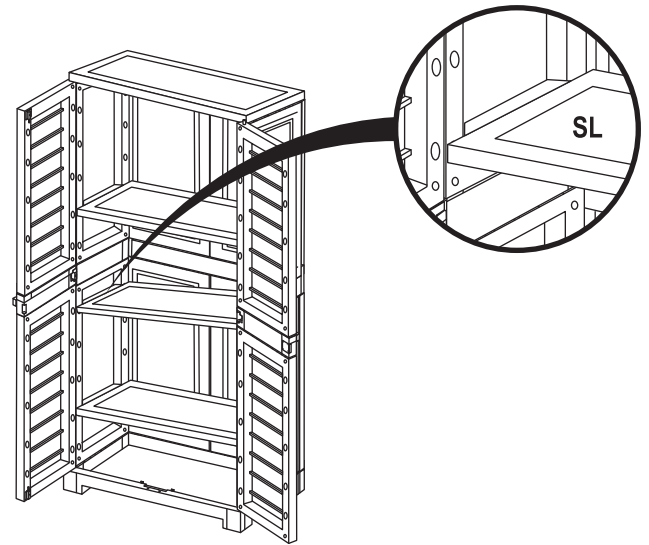

Insert Shelf (SL) into the unit at a slight angle and align the shelf with one side of the unit. Then, gently press on the opposite side of the shelf until the shelf locks into place.

Care & Maintenance

SAFE USE: Only use on a flat, level surface. Do not exceed the weight capacity of each shelf. To prevent shelves from sagging, ensure weight is evenly distributed. **DO NOT allow children or pets to play on OR inside the storage cabinet.** Keep doors closed and secured when not in use.

LOCATION: Recommended for indoor use only. Avoid using this unit in locations that may freeze such as an unheated garage, porch or outdoor patio.

CLEAN: When necessary, hand-wash the unit with a damp cloth. Do not use abrasive detergents, materials or cleaning tools.

To remove tough dirt and grime, mix mild detergent with warm water and use a soft cloth to gently scrub surfaces. Then, use a clean cloth and clean water to remove any residual detergent; if detergent. If necessary, use a soft, lint-free cloth to dry the unit.

INSPECT: Occasionally check the unit to ensure all components are firmly secured and polypropylene is intact.

⚠️ WARNING:

Manufacturer and seller expressly disclaim any and all liability from personal injury, property damage or loss, whether direct or indirect, or incidental, resulting from the incorrect attachment, improper use, inadequate maintenance, or neglect of this product.

SAFETY STATEMENTS & WARNINGS

- Keep this product on a flat, level surface.
- Do not stand or climb on any part of this unit.
- Do not exceed the weight capacity of the unit.
- Distribute weight evenly throughout the unit to avoid tipping.
- Do not allow children to use this product.
- Locking the unit when adults are not present is highly recommended.
- Do not use this item in the proximity of open flame or flammable/combustible chemicals.
- Keep furniture a safe distance from high-heat sources such as air vents, heaters, and grills.
- Do not place hot items on the unit.
- Do not use harsh chemicals or abrasive materials to clean this unit.
- This product is for residential use only; institutional or commercial use will void this warranty.

Any modification to the product or failure to follow recommended care will void the product warranty.

If you experience issues with assembly or the product was damaged during shipping, please contact our customer service team through one of the methods mentioned at the top of page 1.

Please have the item number and order information ready to expedite response time.

WARNING!

Manufacturer and seller expressly disclaim any and all liability from personal injury, property damage or loss, whether direct or indirect, or incidental, resulting from the incorrect attachment, improper use, inadequate maintenance, or neglect of this product.