

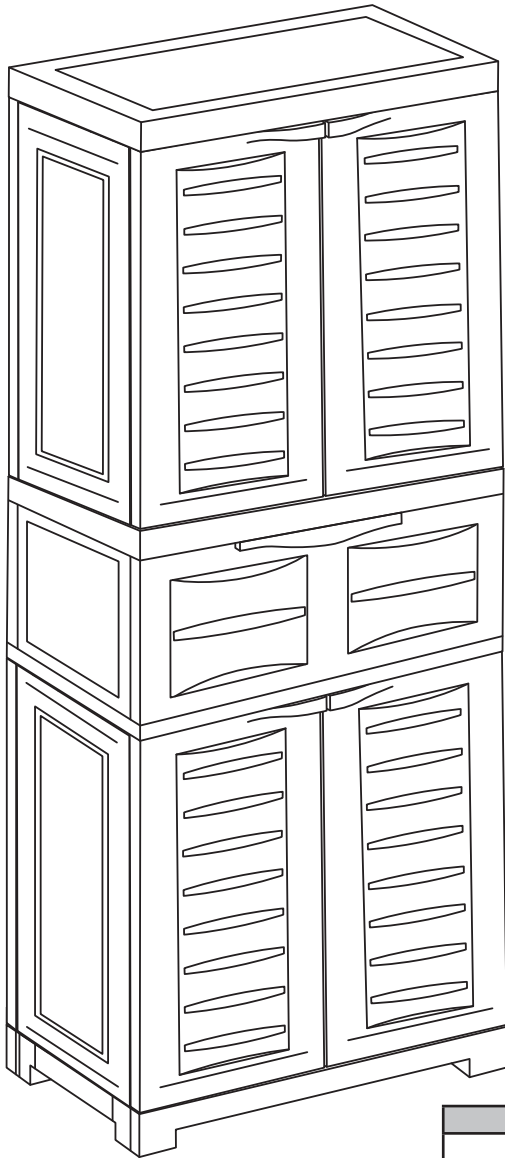





STORAGE CABINET WITH 2 ADJUSTABLE SHELVES & MIDDLE DRAWER

Review all assembly and care information before using this product. Save this manual for future reference.

Assemble components on a soft, clean surface to avoid damaging the finish.

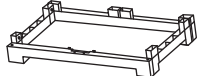

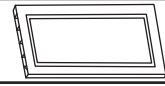
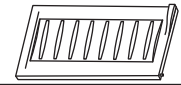
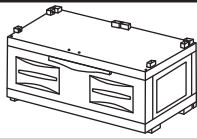

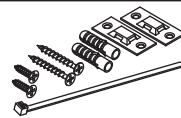
Inspect packaging to ensure all parts are accounted for before disposing of packing materials.
 Save the packing slip.

NO.	CODE	PARTS		QTY.
1	TP		Top Panel	1
2	BT		Bottom Panel	1
3	SP		Side Panel	4
4	BP		Back Panel	4
5	DR		Door Panel	4
6	MDR		Middle Drawer	1
7	SL		Shelf	2
8			Anti-Tip Kit	1

30 pounds
13.6 kg
Weight Capacity per Shelf/Drawer

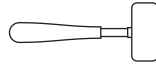
CAUTION:
Distribute weight evenly throughout the unit to avoid tipping.

TOOLS REQUIRED (not included)	
 Rubber Mallet	 Power Drill with 5mm Bit

	SCAN THIS CODE WITH A SMARTPHONE TO VIEW OUR ASSEMBLY VIDEO
---	--

ASSEMBLY

STEP 1

IMPORTANT:

Carefully follow all drawings to ensure components are installed facing the correct direction.

BT: 1

BP: 2

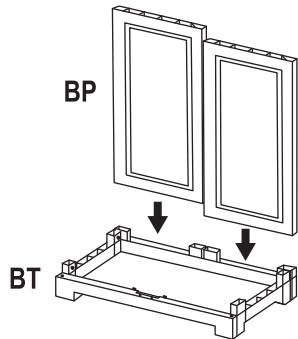

Affix two Back Panels (BP) to Bottom Panel (BT), as shown.

STEP 2

SP: 2

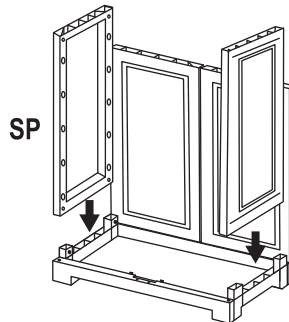

Affix two Side Panels (SP) to the bottom panel, as shown.

STEP 3

DR: 2

MDR: 1

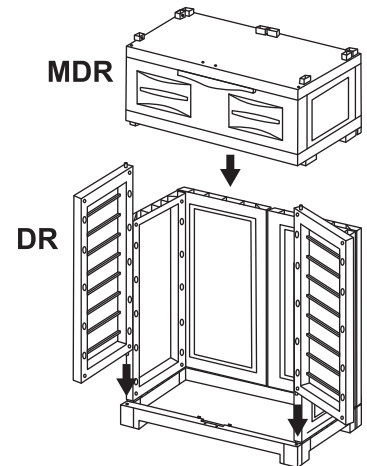

Ensuring the handles are on top, align two Door Panels (DR) with the mounting holes in the bottom panel.

Then, affix Middle Drawer (MDR) to the panels.

STEP 4

BP: 2

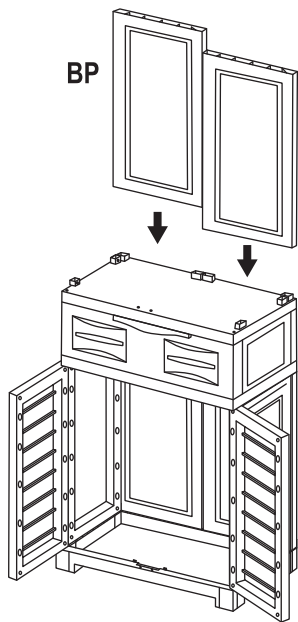

Affix two Back Panels (BP) to the back of the drawer.

STEP 5

SP: 2

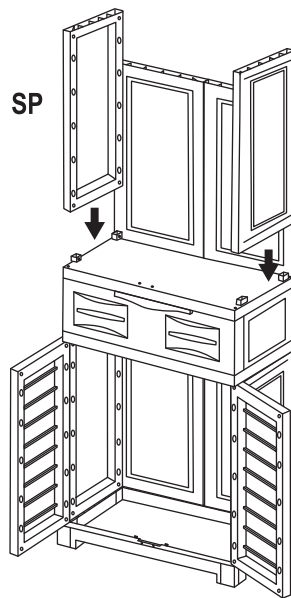

Affix two Side Panels (SP) to the sides of the drawer.

STEP 6

DR: 2

TP: 1

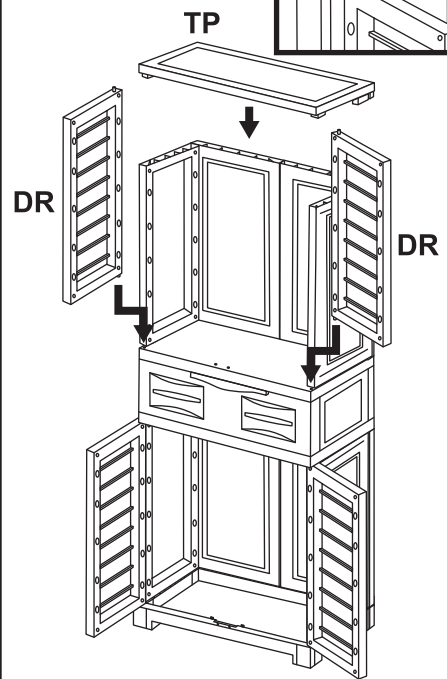

Ensuring the handles are on top, align two Door Panels (DR) with the drawer and affix Top (TP).

STEP 7

SL: 2

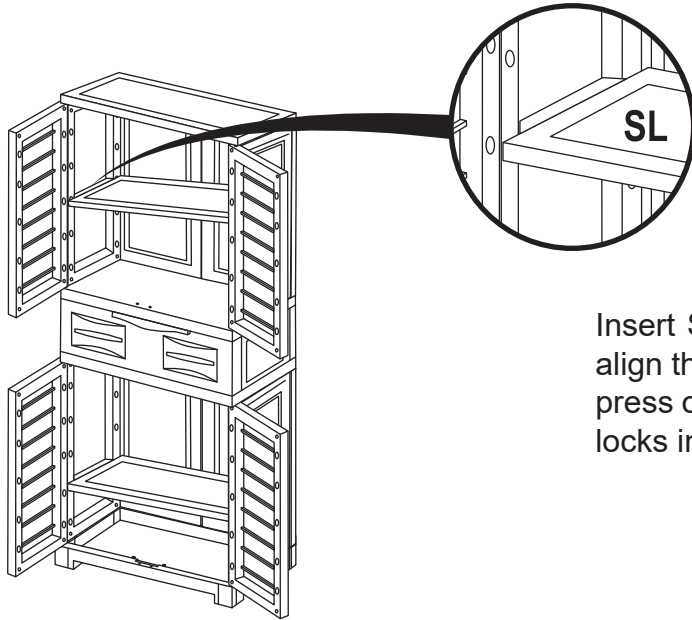

Insert Shelf (SL) into the unit at a slight angle and align the shelf with one side of the unit. Then, gently press on the opposite side of the shelf until the shelf locks into place.

STEP 8

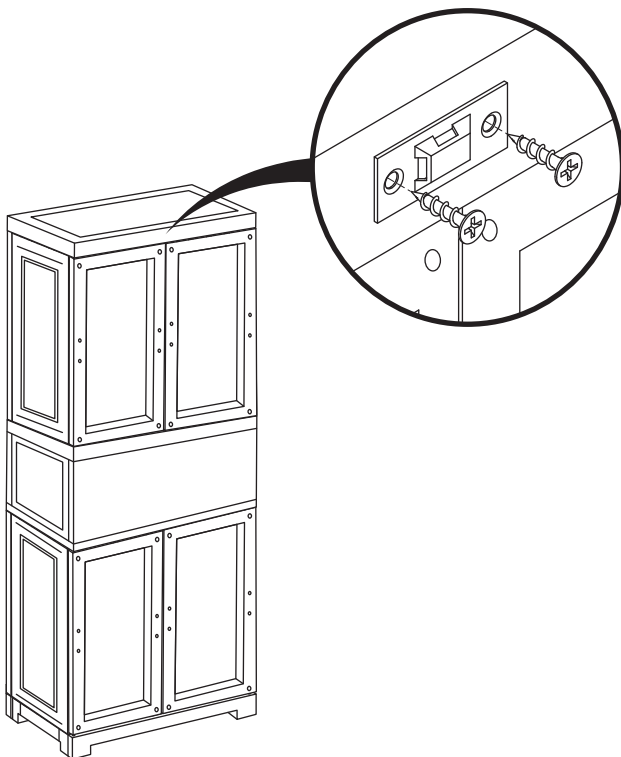

Secure one mounting tab to the back of the top panel using the short screws.

STEP 9

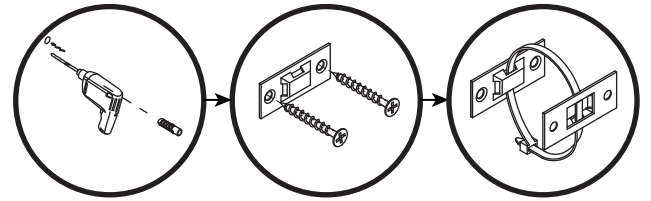

WARNING: Check for pipes and electrical wiring before drilling.

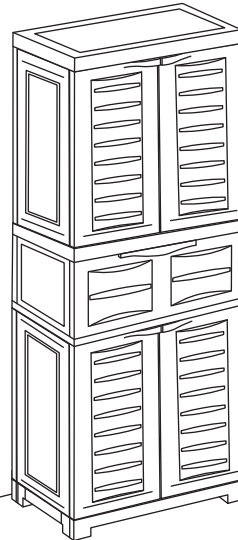

IMPORTANT: The anchors are designed for use with drywall only, other wall types will require special fittings (not included). When in doubt, consult a professional.

Carefully measure and mark the location of drywall anchor pilot hole before drilling and installing the unit.

Using a power drill with a 5mm bit, drill a hole to 30mm depth.

Insert the wall anchor into the hole until the opening is flush with the wall.

Secure the remaining mounting tab to the wall using the long screws.

Align the mounting tabs of the cabinet and wall, secure using the zip tie.

Care & Maintenance

SAFE USE: Only use on a flat, level surface. Do not exceed the weight capacity of the shelves and drawer. To prevent sagging, ensure weight is evenly distributed. **DO NOT allow children or pets to play on OR inside the storage cabinet.** Keep doors closed and secured when not in use.

LOCATION: Recommended for indoor use only. Avoid using this unit in locations that may freeze such as an unheated garage, porch or outdoor patio.

CLEAN: When necessary, hand wash the unit with a damp cloth. Do not use abrasive detergents, materials or cleaning tools.

To remove tough dirt and grime, mix mild detergent with warm water and use a soft cloth to gently scrub surfaces. Then, use a clean cloth and clean water to remove any residual detergent. If necessary, use a soft, lint-free cloth to dry the unit.

INSPECT: Occasionally check the unit to ensure all components are firmly secured and polypropylene is intact.

SAFETY STATEMENTS & WARNINGS

- Keep this product on a flat, level surface.
- Do not stand or climb on any part of this unit.
- Do not exceed the weight capacity of the unit.
- Distribute weight evenly throughout the unit to avoid tipping.
- Do not allow children to use this product.
- Do not use this item in the proximity of open flame or flammable/combustible chemicals.
- Keep furniture a safe distance from high-heat sources such as air vents, heaters, and grills.
- Do not place hot items on the unit.
- Do not use harsh chemicals or abrasive materials to clean this unit.
- This product is for residential use only; institutional or commercial use will void this warranty.

Any modification to the product or failure to follow recommended care will void the product warranty.

If you experience issues with assembly or the product was damaged during shipping, please contact our customer service team through one of the methods mentioned at the top of page 1. Please have the item number and order information ready to expedite response time.

WARNING!

Manufacturer and seller expressly disclaim any and all liability from personal injury, property damage or loss, whether direct or indirect, or incidental, resulting from the incorrect attachment, improper use, inadequate maintenance, or neglect of this product.