

# User's Manual

## 506CA IN-DASH CD RECEIVER



# BOSS®

## AUDIO SYSTEMS



**506CA**

**In-Dash AM/FM  
CD Receiver**

Congratulations on your purchase  
of a **BOSS** In-Dash CD Receiver.  
AUDIO SYSTEMS

It has been designed, engineered  
and manufactured to bring you the  
highest level of performance and  
quality, and will afford you years of  
listening pleasure.

Thank you for making a **BOSS** your  
choice for car audio entertainment.  
AUDIO SYSTEMS

## USER'S MANUAL

*page* CONTENTS

---

2	Installation
4	Using the Detachable Front Panel
4	Disc Notes
6	Operation
6	Features and Controls
7	General Operation
8	Radio Operation
8	CD Operation
8	AUX In Operation
9	Wiring Diagram
9	Specifications
10	Troubleshooting

## Installation

### Notes:

- Choose the mounting location where the unit will not distract the driver.
- Before finally installing the unit, connect the wiring temporarily and make sure it is all connected properly and the unit and the system works properly.
- Use only the parts included with the unit to ensure proper installation. The use of unauthorized parts can cause malfunctions.
- Consult with your nearest dealer if installation requires the drilling of holes or other modifications to the vehicle.
- Install the unit where it does not get in the driver's way and cannot injure the passenger if there is a sudden stop.
- If installation angle exceeds 30° from horizontal, the unit may not provide optimum performance.

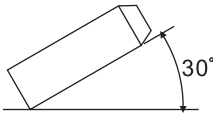

- Avoid installing the unit where it would be subject to high temperature, such as from direct sunlight, or from hot air from the heater, or where it would be subject to dust, dirt or excessive vibration.

### DIN Front/Rear-Mount

This unit can be properly installed either from 'Front' (conventional DIN Front-mount) or 'Rear' (DIN Rear-mount installation, utilizing threaded screw holes on the sides of the unit chassis). For details, refer to the following illustrated installation methods.

### Take out transit screws before installation

Before installing the unit, please remove the two screws.

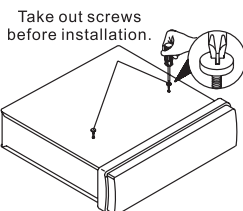

## 1. DIN Front-mount (Method A)

### Installation opening

This unit can be installed in any dashboard with an opening as shown below:

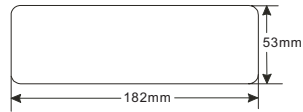

### Installing the unit

Be sure you test all connections first, and then follow these steps to install the unit.

1. Make sure the ignition is turned off, and then disconnect the cable from the vehicle battery's negative (-) terminal.
2. Disconnect the wire harness and the antenna.
3. Press the **REL** button (1) on the front panel and remove the control panel (for details, refer to 'Using the Detachable Front Panel', page 4).
4. Lift the top of the outer trim ring, then pull it out to remove it.
5. The two supplied keys release tabs inside the unit's sleeve so you can remove it. Insert the keys as far as they will go (with the notches facing up) into the appropriate slots at the middle of the left and right sides of the unit. Then slide the sleeve off of the unit.

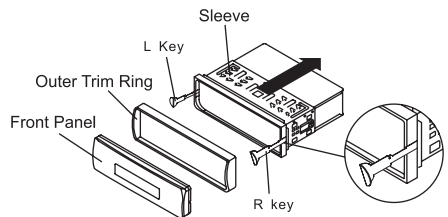

6. Mount the sleeve by inserting the sleeve into the opening of the dashboard and bend open the tabs located around the sleeve with a screwdriver. Not all tabs will be able to make contact, so examine which ones will be most effective. Bend open the appropriate tabs behind the dashboard to secure the sleeve in place.

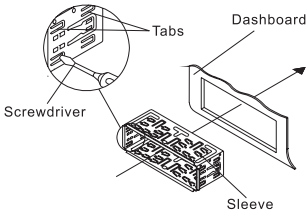

7. Reconnect the wire harness and the antenna and be careful not to pinch any wires or cables.

8. Slide the unit into the sleeve until it locks into place.

9. To further secure the unit, use the supplied metal strap to secure the back of the unit in place. Use the supplied hardware (Hex Nut (M5mm) and Spring Washer) to attach one end of the strap to the mounting bolt on the back of the unit. If necessary, bend the metal strap to fit your vehicle's mounting area. Then use the supplied hardware (Tapping Screw (5x25mm) and Plain Washer) to attach the other end of metal strap to a solid metal part of the vehicle under the dashboard. This strap also helps ensure proper electrical grounding of the unit.

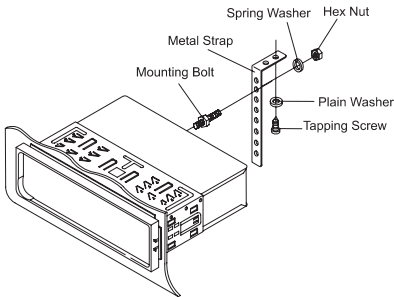

10. Reconnect the cable to the vehicle battery's negative (-) terminal. Then replace the outer trim ring and install the unit's front panel (see the steps of 'Installing the Front Panel', page 4).

## Removing the unit

1. Make sure the ignition is turned off, and then disconnect the cable from the vehicle battery's negative (-) terminal.
2. Remove the metal strap attached to the back of the unit (if attached).

3. Press the release button to remove the front panel.

4. Lift the top of the outer trim ring and then pull it out to remove it.

5. Insert both of the supplied keys into the slots at the middle left and right sides of the unit then pull the unit out of the dashboard.

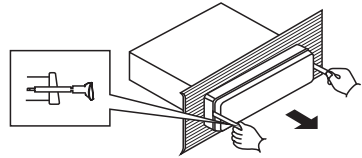

## 2. DIN Rear-mount (Method B)

If your vehicle is a Nissan or Toyota, follow this mounting instruction. Use the screw holes marked T (Toyota) or N (Nissan) located on both sides of the unit to fasten the unit to the factory radio mounting brackets supplied with your vehicle.

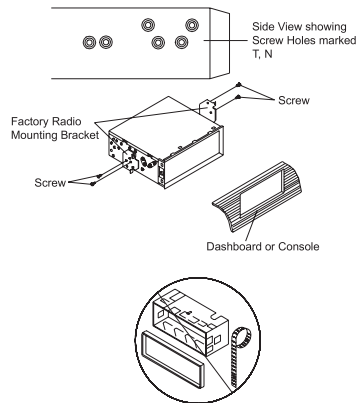

Align the screw holes on the bracket with the screw holes on the unit, and then tighten the screws (5x5mm) on each side.

**Note:** the outer trim ring, sleeve and the metal strap are not used for method B installation.

## Using the Detachable Front Panel

### Removing the Front Panel

1. Press the release **REL** button (1) on the front panel.

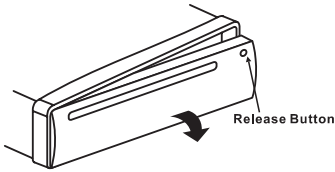

2. Pull off the front panel.

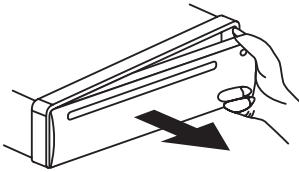

3. Place the front panel into the protective case provided.

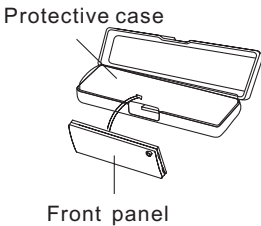

### Installing the Front Panel

To install the front panel, insert the panel into the housing and make sure the panel is properly installed. If the panel is not properly seated in the housing, some of the keys or the display may not function properly. If this occurs, remove and re-insert the front panel.

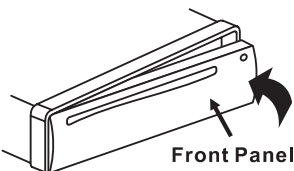

### Precautions when handling

1. Do not drop the front panel.
2. Do not put pressure on the display or control buttons when removing or installing the front panel.
3. Do not touch the contacts on the front panel or on the main unit body. It may result in poor electrical contact.
4. If any dirt or foreign substances are present on the contacts, they can be removed with a clean and dry cloth.
5. Do not expose the front panel to high temperatures or direct sunlight.
6. Do not allow any volatile liquids such as benzene, paint thinner or insecticides to contact the front panel.
7. Do not attempt to disassemble the front panel.

### Disc Notes

#### A. Notes on discs:

1. Attempting to use non-standard shape discs (e.g. square, star, and heart) may damage the unit. Be sure to use circular CD discs only for this unit.
2. Do not stick paper or tape, etc. onto the label side or the recording side of any discs, as it may cause a malfunction. Dust, scratches and warped discs may inhibit playback.

#### B. Notes on CD-Rs (recordable CDs)/CD-RWs (rewritable CDs):

1. The unit cannot play a CD-R and CD-RW that is not finalized. (Please refer to the manual of your CD-R/CD-RW recorder or CD-R/CD-RW software for more information on finalization process).
2. Depending on the recording status, conditions of the disc and the equipment used for the recording, some CD-Rs/CD-RWs may not be played on this unit. For more reliable play back:

A. Use CD-RWs with speed 1x to 4x and written with speed 1x to 2x.

B. Use CD-Rs with speed 1x to 8x and written with speed 1x to 2x.

C. Do not play a CD-RW which has been written for more than 5 times.

### C. Handling and Cleaning

- Dirt, dust, scratches and warped discs may inhibit playback.
- Do not place stickers or make scratches on discs.
- Do not warp discs.
- A disc should always be kept in its case when not in use to prevent damage.
- Do not expose discs to direct sunlight or place in dirty, dusty or damp areas. Do not store near the heater vent of your car, or leave on the seats or dashboard.

### Disc Cleaning

Use a dry soft cloth to wipe the surface. If the disc is quite dirty, use a soft cloth, lightly dampened with isopropyl (rubbing) alcohol. Never use solvents such as benzene, thinner or conventional record cleaners as they may mar the surface of the disc.

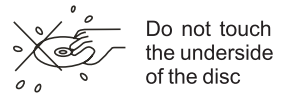
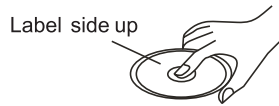

Wipe the disc from center toward the outside edge

### D. Preparing New Discs with Rough Spots

A new disc may have rough edges on its inside and outside edges. If a disc with rough edges is used, the proper setting will not be performed and the player will not play the disc. Therefore, remove the rough edges in advance by using a ballpoint pen or pencil as shown on the right. To remove the rough edges, rub the side of the pen or pencil against the inside and outside edges of the disc.

Rough spots on outside edge

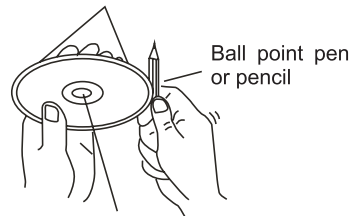

Rough spots on inside edge

# Operation

## Features and Controls

Front panel:

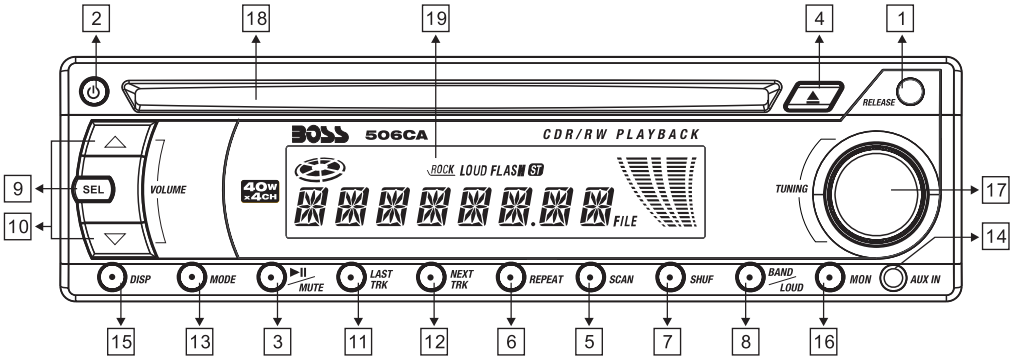

Rear of front panel:

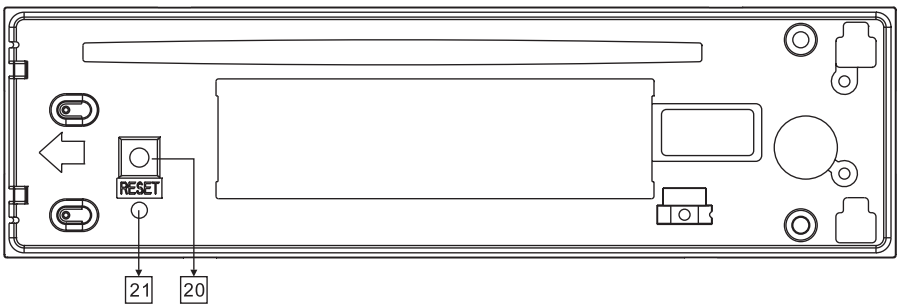

## General Operation

### Turning on/off the unit

Turn on the unit by pressing any button (except **REL** button (1) or **▲** button (4)) or by inserting a disc in the disc slot (18). When system is on, press **⏻** button (2) to turn off the unit.

### Sound adjustment

Press **VOL ▲/▼** button (10) to adjust the volume level.

Press the **SELECT** button (9) repeatedly to cycle through the following sound adjustment choices:



Press **VOL ▲/▼** button (10) to adjust the desired sound quality.

Once you are in the MENU mode, press the **SELECT** button repeatedly to cycle through the following setup choices:

BEEP ON/OFF → P-VOL →  
CLK ON/OFF → 12/24 HOUR

Select the desired item by press **VOL ▲/▼** button (10).

### Loudness function

Press and hold the **BAND/LOUDNESS** (8) to engage the **LOUDNESS** mode to reinforce the output of bass frequencies. Press and hold again to turn off **LOUDNESS**.

### Displaying/Adjusting time

#### 1. Displaying time:

Press **DISP** button (15) to show current information and time on the LCD. Return to original status after 5 seconds.

#### 2. Adjusting time:

Press and hold **DISP** (15) until the clock

begins blinking. You can press **VOL ▲** (10) to adjust hour, and **VOL ▼** (10) to adjust minute.

### Mute function

Press **MUTE** (3) to reduce the sound level instantly. Press it again to return to the previous volume level.

### LCD display

Exhibits the current frequency and activated functions on the LCD (19).

### Flashing LED

The LED (21) will flash if the front panel is not inserted into properly the main unit.

### Reset function

The **RESET** button is to be activated for the following reasons:

- Initial installation of the unit when all wiring is completed.
- All the function buttons do not operate.
- Error symbol on the display.

**RESET** button (20) must be activated with either a ballpoint pen or thin metal object. If after pressing **RESET** button the unit still does not function properly, use a cotton swab soaked in isopropyl alcohol to clean the socket on the back of front panel.



## Radio Operation

### Switching to radio mode

Press **MODE** button (13) to select radio mode. The radio mode appears in the display together with the memory band and frequency.

### Selecting the frequency band

Press **BAND** button (8) to select the desired band. The reception band will change between FM and AM.

### Stereo/Mono

Press **MONO** button (16) to select mono or stereo mode.

### Tune button

Rotate **TUNE** button (17) to select a broadcasting station.

## CD Operation

### Switching to CD mode

1. If there is no CD disc inserted in the driver:  
Gently insert a CD with the printed side up into the Disc Slot (18) until you feel some resistance. The disc will be drawn into the player automatically. The CD playback begins.
2. If a CD disc is already present in the player, press **MODE** button (13) to switch to CD mode.

### Loading a disc

Insert the disc into the disc slot (18) with the printed side facing up. The player will play the disc automatically.

### To remove the disc

Press **▲** button (4) to stop playback and eject the disc from the Disc Slot (18).

### Selecting tracks in single step

Press **LAST TRK** button (11) or **NEXT**

**TRK** button (12) to skip to the previous track or the next track. The track number will show on the display.

Press and hold **LAST TRK** button (11) or **NEXT TRK** button (12) to fast reverse or fast forward. To return to the normal mode, release the button.

### Pause playback

Press **⏸** button (3) to pause CD playback. Press it again to resume playback.

### Previewing all tracks

Press **SCAN** button (5) to play first several seconds of each track on the current disc. Press it again to stop intro scan and listen to track.

### Repeating the same track

Press **REPEAT** button (6) to set the unit to repeat the same track. Press it again to stop the repeat function.

### Playing all tracks in random

Press **SHUF** button (7) to play all tracks on the disc in random order. Press it again to cancel this function.

## Aux In Operation

This receiver has a front panel auxiliary input jack, It is compatible with the audio output from iPod and other MP3 music players. If you have plugged such a player into the AUX IN jack, Press the **MODE** button (13) to switch the input source to **AUX** .

# Wiring Diagram

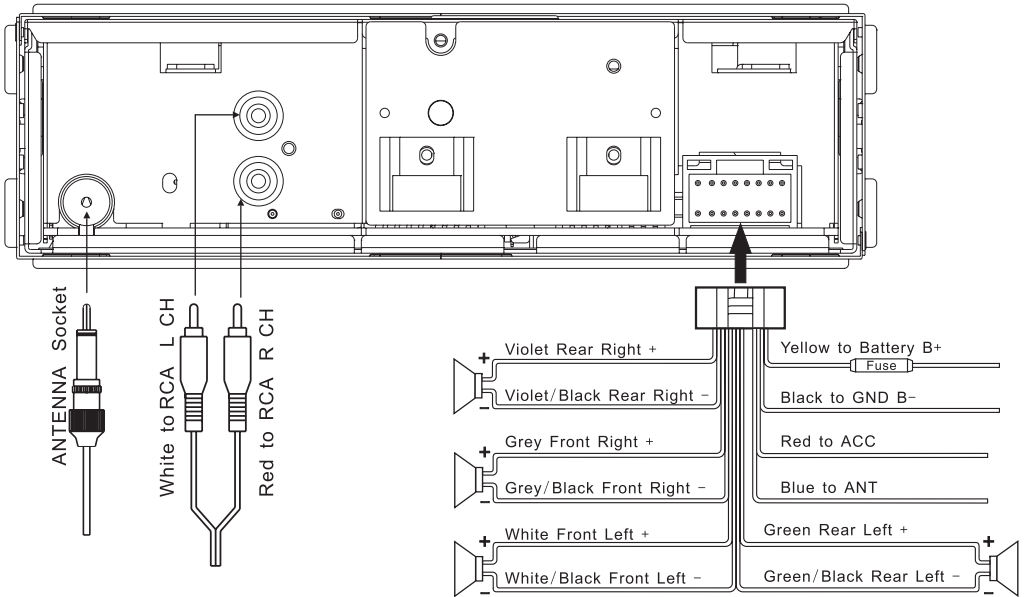

## Specification

### 1. GENERAL

Power Supply Requirements  
DC 12 Volts, Negative Ground

Chassis Dimensions  
178(W)x160(D)x 50(H)

#### Tone Controls

- Bass (at 100 Hz)  $\pm 14$  dB
- Treble (at 10 kHz)  $\pm 14$  dB

Maximum Output Power: 4x40 watts

Current Drain: 10 Ampere (max.)

### 2. CD PLAYER

Signal to Noise Ratio: > 55 dB

Channel Separation: > 40 dB

Frequency Response: 40Hz - 18 KHz

### 3. RADIO

#### FM

Frequency Coverage: 87.5-107.9 MHz

IF: 10.7 MHz

Sensitivity (S/N=30dB): 4 $\mu$ V

Stereo Separation: >20dB

#### AM

Frequency Coverage: 530-1710 KHz

IF: 450 KHz

## Trouble Shooting

Before attempting to troubleshoot a problem, first make sure that all wiring is done properly. If problems persist after you have made an effort to troubleshoot using some of the ideas below, see a qualified mobile audio technician.

Symptom	Cause	Solution
No power.	The car ignition switch is not on.	If the power supply is connected to the car accessory circuits, but the engine is not moving, switch the ignition key to "ACC".
	The fuse is blown.	Replace the fuse.
Disc cannot be loaded or ejected.	There is already a disc in the player.	Remove the disc in the player, and then put a new one.
	The disc has been inserted upside down.	Insert the compact disc with the label facing upward.
	Compact disc is extremely dirty or defective.	Clean the disc or try to play a new one.
	Condensation is present in the player.	Cool off or wait until the ambient temperature returns to normal.
	Condensation is present in the player.	Leave the player off for an hour or so, and then try again.
No sound.	The volume level is turned all the way down.	Adjust volume to a desired level.
	Wiring is not properly connected.	Check wiring connection.
Sound skips.	The disc is extremely dirty or a defective disc.	Fix the installation so that the unit is less than 30° from horizontal.
	The unit is installed at an angle of greater than 30°.	Clean the compact disc, and then try to play a new one.
The front panel buttons do not operate properly.	The built-in microcomputer is not operating properly due to electrical noise.	Press the RESET button Front panel is not properly fixed into its place.
The radio does not work. The radio station automatic selection does not work.	The antenna cable is not connected.	Insert the antenna cable firmly.
	The signals are too weak.	Select a station manually.

**506CA**  
**IN-DASH CD RECEIVER**

03.2010

**tech support:** [www.bosssaudio.com/support](http://www.bosssaudio.com/support)

iPod is a trademark of Apple Computer, Inc.,  
registered in the U.S. and other countries.



10R-02 3981

**BOSS®**  
**AUDIO SYSTEMS**

BOSS Audio Systems • 3451 Lunar Court • Oxnard, CA 93030

[www.bosssaudio.com](http://www.bosssaudio.com)

**800.999.1236**