

Ecostat Classic
Thermostatic Trim with Volume Control and Diverter, Round
 Finishes : **polished nickel** Part no. : **15753831**



Description

Features

- Volume control and diverter for 2 outlets
- Flow: 7.0 GPM (26.5 L/Min)
- Thermostatic cartridge, Shut-off/ diverter valve
- Anti-scald 100° safety stop

Item details

List Price \$ 759.00

Compliance



Product image



Scale drawing

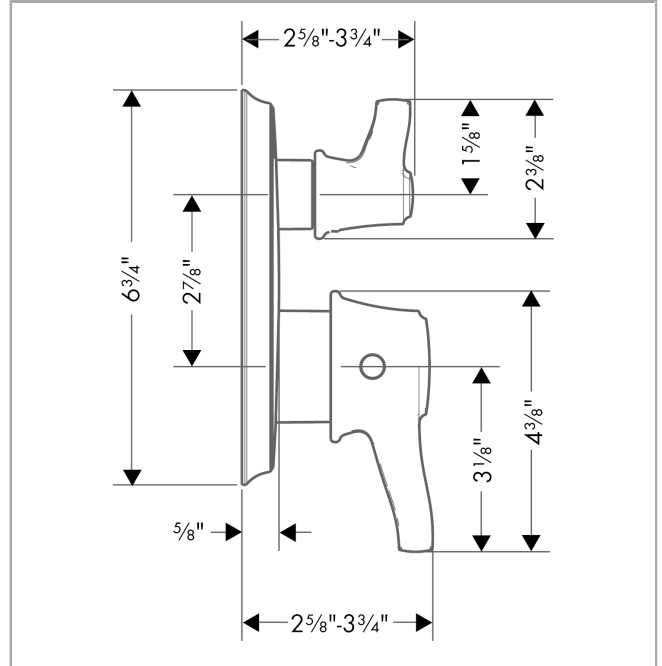

Ecostat Classic
Thermostatic Trim with Volume Control and Diverter, Round
 Finishes : **polished nickel** Part no. : **15753831**



Exploded drawing

Year of production: >12/10

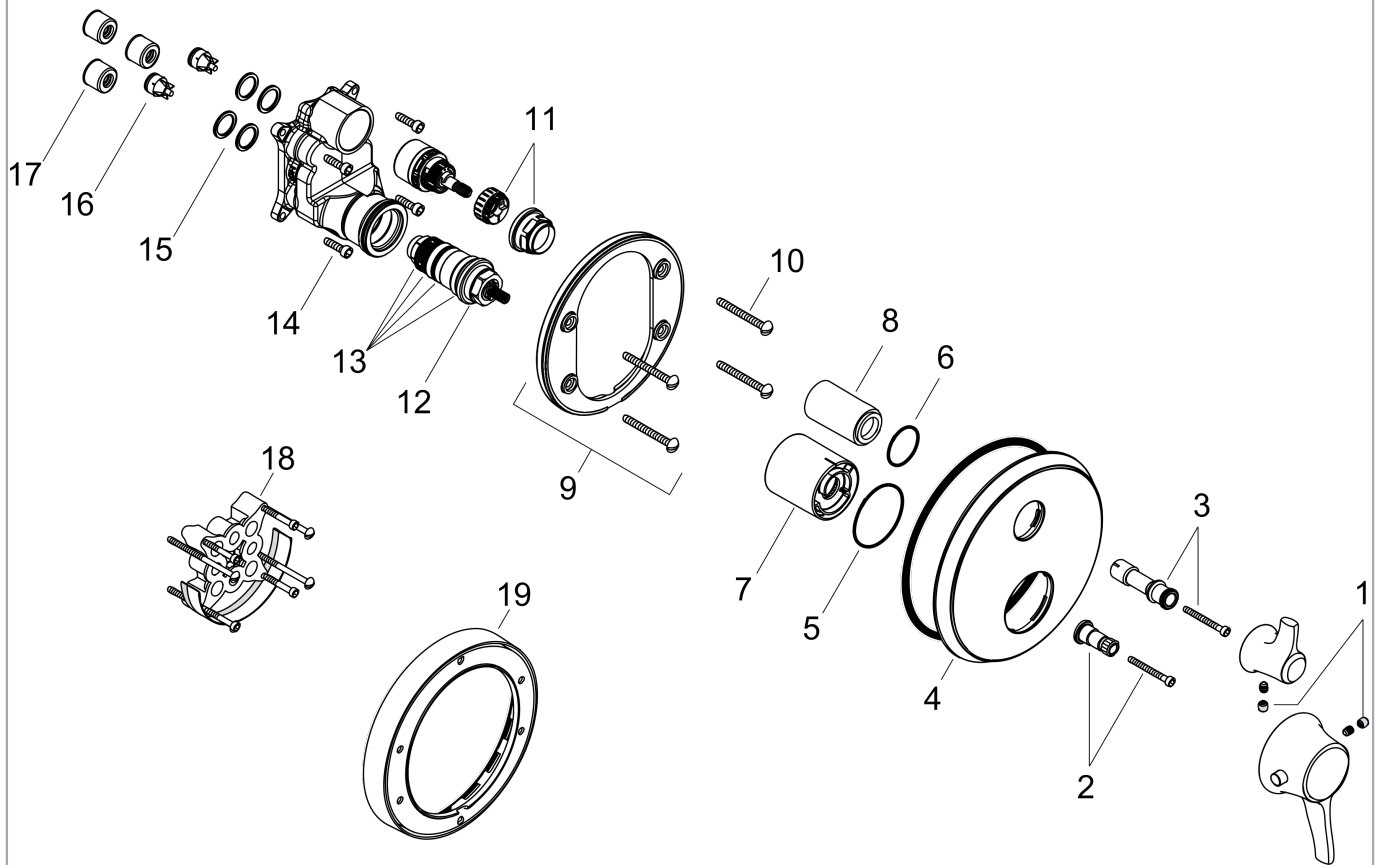

Ecostat Classic
Thermostatic Trim with Volume Control and Diverter, Round
 Finishes : **polished nickel** Part no. : **15753831**



Spare parts list

Year of production: >12/10

Pos.	Description	Part no.	Price	PU
1	screw cover	95181000	-	1
2	adapter for handle	96435000	-	1
3	adapter for handle	88772000	-	1
4	escutcheon	95556831	-	1
5	O-Ring 48x3	95508000	-	1
6	O-ring 29x3	98371000	-	1
7	sleeve	95550830	-	1
8	sleeve	95253830	-	1
9	holder for escutcheon	98793000	-	1
10	set of fixing screws	96454000	-	1
11	shut off unit with selector	98283000	-	1
12	thermostat cartridge	94282000	-	1
13	sealing set	95037000	-	1
14	set of screws	96525000	-	1
15	O-ring 16x2	98133000	-	1
16	set of non return valves DW 15	94074000	-	1
17	noise reduction	94073000	-	1
18	extension 25 mm	13595000	-	1
19	extension 22 mm (Ø 170 mm)	13596830	-	1
a	non return valve with filter	92499000	-	1