

6-Hole 3.5" x 3.5", 5/8" Radius Door Hinge 12-Pack
Antique Brass

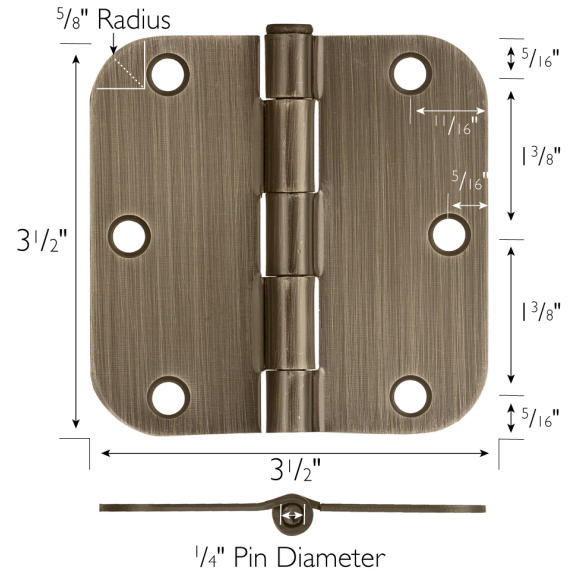

SPECIFICATIONS

MATERIAL CONSTRUCTION:	Steel
MOUNTING HARDWARE INCLUDED:	#9 x 3/4" screws x 6
TOOLS NEEDED FOR INSTALLATION:	Screwdriver
ASSEMBLED DIMENSIONS:	3.5" H x 3.5" L x 0.13" W
ASSEMBLED WEIGHT:	4.93 lbs
CORNER RADIUS:	5/8"
HINGE TYPE:	Butt Hinge

WARRANTY: 1-Year limited warranty

LEGAL FOR SALE IN CALIFORNIA: Yes



TYPE:
JOB:
ORDER CODE:
APPROVALS: