







Item: 6120-90251-80 5/0 Panel Headboard
 6120-90252-80 5/0 Panel Footboard
 6120-90253-80 5/0 - 6/6 Panel Rails

Thank you for purchasing this quality product. Be sure to unpack carefully looking for small parts which may have come loose during shipment.

Read all instruction and study the drawing carefully before starting the assembly process:

HARDWARE PACK

NO	DRAWING	DESCRIPTION	SIZE	Q'TY
A		Screw	8#*1"	8pcs
B		Hexagonal Bolt	Φ5/16"*2"	10pcs
C		Lock Washer	Φ5/16"×12×3	18pcs
D		Flat Washer	Φ5/16"×19×2	18pcs
E		Threaded Rod	Φ5/16"*4"	8pcs
F		Nut	Ø5/16"*12	8pcs
G		Hex Wrench	12MM	1pc

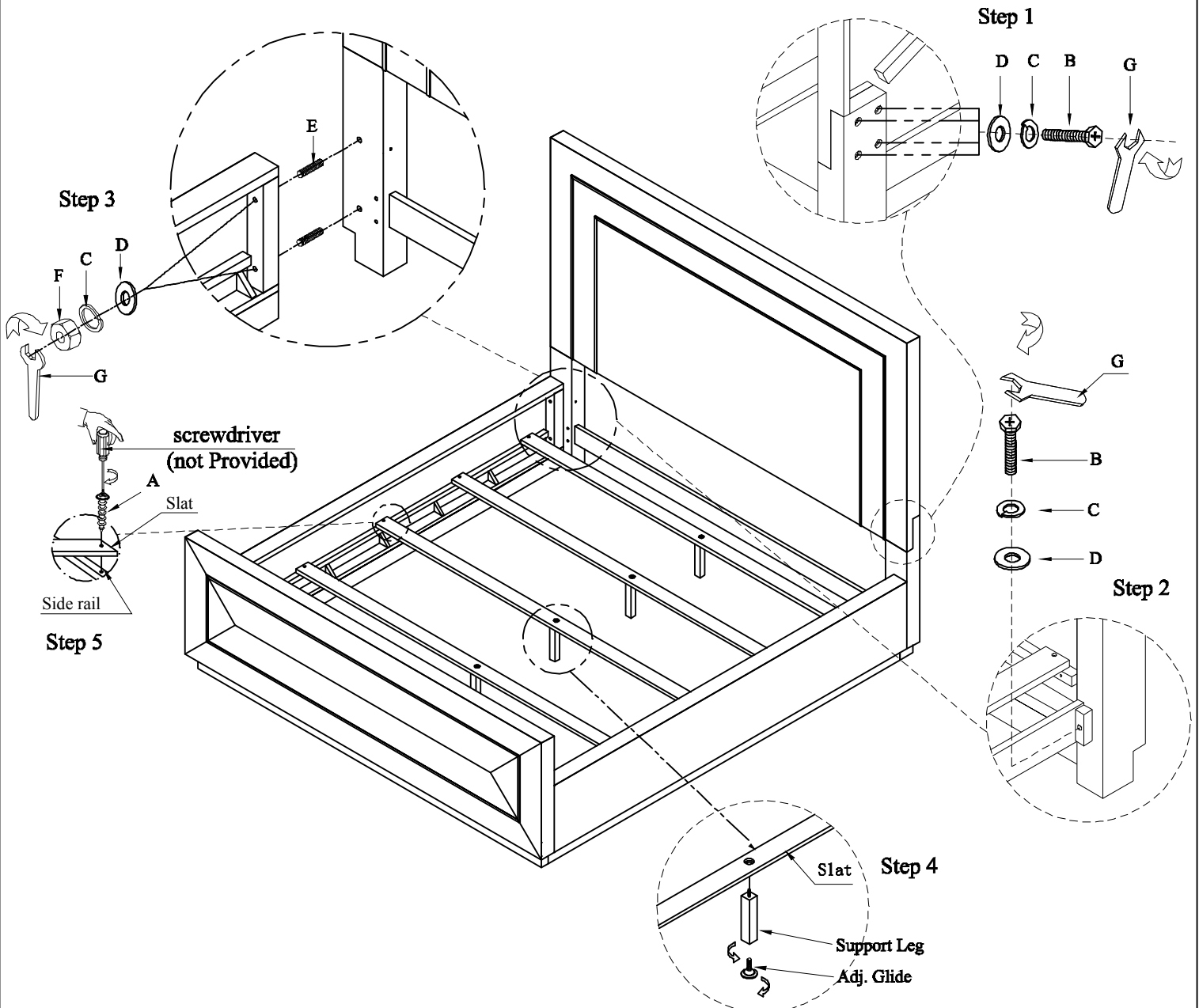

Adjust levelers if needed, to level case on uneven floor