

USER'S MANUAL

BVCP9675A

BLUETOOTH® | MP3-COMPATIBLE AM/FM RECEIVER



BOSS Audio Systems
3451 Lunar Court • Oxnard, CA 93030

www.bossaudio.com

800-999-1236 US Toll-free

805-751-4853 Customer Service

tech support: www.bossaudio.com/support/technical-support



1017

iPhone® is a trademark of Apple, Inc. registered in the U.S. and other countries. BOSS Audio Systems is not affiliated with Apple, Inc.

The Bluetooth® word mark and logos are registered trademarks owned by Bluetooth SIG, Inc. and any use of such marks by BOSS Audio Systems is under license. Other trademarks and trade names are those of their respective owners.

Use of the Apple CarPlay logo means that a vehicle user interface meets Apple performance standards. Apple is not responsible for the operation of this vehicle or its compliance with safety and regulatory standards. Please note that the use of this product with iPhone or iPad may affect wireless performance.

USER'S MANUAL

BVCP9675A **BLUETOOTH®** | MP3-COMPATIBLE AM/FM RECEIVER
FEATURING 6.75" (171 mm) CAPACITIVE TOUCHSCREEN





Contents

Contents	2	Android Auto	19	Radio	25
Notes.....	4	Warnings.....	19	Display Overview.....	25
FCC Statement.....	6	Using Android Auto.....	19-21	Controls.....	25
Cautions.....	7-9	Bluetooth®	22	Tuning.....	25
About this Manual.....	9	Cautions.....	22	Bands.....	25
California Prop. 65.....	9	Setup & Connections.....	22	RBDS.....	25
Basic Product Operation	10	Phonebook.....	22	Presets.....	25
What comes in the box.....	10	Device Status.....	22	Favorites.....	25
Product Basics.....	11-16	Calling.....	23	Aux-In	26
Using/Caring for the Touchscreen.....	14	History.....	23	Playback.....	26
Product Setup.....	15	Private Mode.....	23	Camera	26
Navigating the Menus.....	16	Call Waiting.....	23	Warnings.....	26
Apple CarPlay	17	Audio.....	22	Reverse View.....	26
Warnings.....	17	Track Control.....	22	Audio	27
Using CarPlay.....	17	Media Player Source Switching.....	22	EQ.....	27
Gestures & Control.....	17	Media	24	Balance/Fader.....	27
CarPlay Display.....	18	Warnings.....	24	Key Beep.....	27
Disable Apps.....	18	USB Playback.....	24		
		Navigating Menu.....	24		
		Photos.....	24		

Contents

Audio Cont'd.....	27	Bluetooth® Settings.....	29	Connections.....	32
Internal Amp.....	27	Power.....	30	Cautions & Warnings.....	32-35
Loudness.....	27	Auto Connect.....	30	Warnings.....	38
Subwoofer.....	27	Auto Answer.....	30	Power	32
General Settings.....	28	Phonebook Download.....	29	Speaker.....	33
Cautions.....	28	Contact Display.....	29	Pre-amp Outputs.....	34
Date & Time.....	28	Device Name.....	29	Camera.....	35
System Language.....	28	Radio Settings.....	30	Aux-In.....	35
User Interface.....	28	Seek Quality	30	Steering Wheel Controls.....	36
Rear View Settings.....	28	Region.....	30	USB.....	37
Power Off Delay.....	28	RBDS.....	30	Parking Brake.....	38
Display Settings.....	29	Alternative Frequency (AF).....	30	Hands-free Mic.....	39
Blur Effect.....	29	Traffic Announcement (TA).....	30	Troubleshooting.....	40
Illumination Control.....	29	Steering Wheel Controls.....	31	Specifications.....	42
Gamma.....	29	Connections	36	User's Notes.....	43
LED Touch Buttons.....	29	Programming Functions.....	31		
LED Brightness.....	29	Reset	31		
Animation Effect.....	29				
Illumination Default.....	29				

Important

This symbol with “WARNING” is intended to alert the user to the presence of critical instructions/procedures. Failure to observe the instructions/procedures can result in injury, death, damage to the product and/or property.



This symbol with “CAUTION” is intended to alert the user to the presence of important instructions/procedures. Failure to observe the instructions/procedures can result in injury or damage to the product and/or property.



Apple CarPlay is a trademark of Apple Inc. Use of the Apple CarPlay logo means that a vehicle user interface meets Apple performance standards. Apple is not responsible for the operation of this vehicle or its compliance with safety and regulatory standards. Please note that the use of this product with iPhone or iPod may affect wireless performance.



The *Bluetooth*® word mark and logos are registered trademarks owned by Bluetooth SIG, Inc. and any use of such marks by Boss Audio Systems is under license. Other trademarks and trade names are those of their respective owners.



IMPORTANT

Record the serial number of the product:

Model:

Serial Number:

Date of Purchase:

The serial number is located on the top part of the chassis.

Important

android
auto



Caution

FCC Compliance Statement

This device complies with part 15 of the FCC Rules. Operation is subject to the following two conditions: (1) this device may not cause interference, and (2) this device must accept any interference, including interference that may cause undesired operation of this device. This transmitter must not be co-located or operated in conjunction with any other antenna or transmitter. The Bluetooth antenna cannot be removed (or replaced) by user. This equipment complies with FCC/ IC radiation exposure limits set forth for an uncontrolled environment and meets the FCC radio frequency (RF) Exposure Guidelines and RSS-102 of the IC radio frequency (RF) Exposure rules. This equipment has very low levels of RF energy that it deemed to comply without maximum permissive exposure evaluation (MPE). But it is desirable that it should be installed and operated keeping the radiator at least 20 cm or more away from person's body (excluding extremities: hands, wrists, feet and ankles). Alteration or modifications carried out without appropriate authorization may invalidate the user's right to operate the equipment.

NOTE: This equipment has been tested and found to comply with the limits for a Class B digital device, pursuant to Part 15 of the FCC Rules. These limits are designed to provide reasonable protection against harmful interference in a residential installation. This equipment generates, uses and can radiate radio frequency energy and, if not installed and used in accordance with the instructions, may cause harmful interference to radio communications. However, there is no guarantee that interference will not occur in a particular installation. If this equipment does cause harmful interference to radio or television reception, which can be determined by turning the equipment off and on, the user is encouraged to try to correct the interference by one or more of the following measures: Relocate or reorient the receiving antenna. Increase the separation between the equipment and receiver. Connect the equipment into an outlet on a circuit different from that to which the receiver is connected. Consult the dealer or an experienced radio/TV technician for help.



Caution

Adjustments or alterations of this device may result in hazardous radiation exposure.

Caution

Precautions

BE SURE TO OBSERVE THE FOLLOWING GUIDELINES: Do not turn up the volume so high that you can't hear what's around you.

Use caution or temporarily discontinue use in potentially hazardous situations.

Do not operate mobile video equipment while driving a motorized vehicle – safe driving and safety consideration of others should always be your highest priority.

Set your volume control at a low setting, then slowly increase the sound until you can hear it comfortably without distortion, or ear discomfort.

In the event you should notice smoke, strange noises or odor from this product, or any other abnormal signs, immediately turn off the power and consult your dealer or the nearest authorized **BOSS AUDIO SYSTEMS** Service Center.

Using this product in this condition may result in permanent damage to the system.

Installation Precautions

Boss Audio Systems does not recommend to install the product yourself.

We recommend to have it professionally installed by a certified professional.

Always consult with a professional installer .

Do not attempt to install or service this product by yourself. Installation or servicing of this product by persons without professional training and experience in electronic equipment and motorized vehicle accessories may be dangerous and could expose you to the risk of electric shock, injury or other hazards

Refer any repairs to a qualified BOSS AUDIO SYSTEMS Service Center

Caution

Before Installing

To avoid potential shorts in the electrical system, be sure to disconnect the (-) battery cable before installation.

Use this unit with a 12-volt battery and negative grounding only. Failure to do so may result in a fire or malfunction.

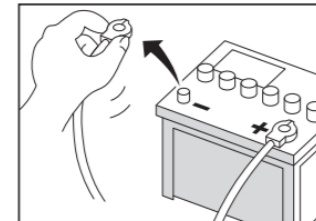
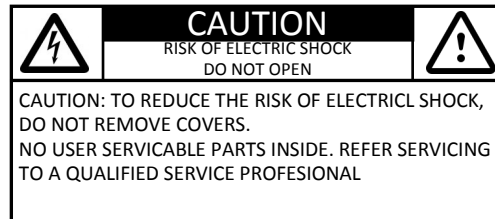

Product Safety

It is against Federal and Local laws for video to be viewed by the driver while the vehicle is in motion. This video product was intended to be used with the parking brake safety feature. Video cannot be seen without the proper parking brake powered connection. Tampering or disabling this feature will void any and all warranty. Please check with a professional installer to have your product installed properly.



Important Note

Due to ongoing enhancements, example images on screens may slightly differ from actual product.

Caution

Images and Video

Watching video while driving is against Federal, State, and Local laws.

Drive safely, know and obey traffic rules. Watching this screen and making selections while driving can lead to a serious accident.

Check surroundings for safety while camera images are displayed.

Do not use features of this product while driving if it cannot be operated safely and legally in your location. Before operation of smartphone Apps accessible from this device, read safety instructions in your Owner's Manual. When using navigation Apps stay alert to observe real world conditions.

About this manual

To entirely understand how to properly use your new Boss product, it is recommended to read this entire user's manual, and keep it in a safe place for future reference.

-Read the entire manual

-Keep the manual

-Follow all instructions

-Clean with a dry cloth only

-Do not use or operate near water

-Do not defeat any safety features

California Residents (Proposition 65)

This product may contain chemicals known to the State of California to cause cancer, birth defects or other reproductive harm.

Basic Product Operation

What comes in the box

Hardware

- Qty 1 BVCP9675A
- Qty 1 Trim Ring
- Qty 1 Mounting Hardware Set
(Not Pictured)
 - M5 x 6mm Bolts (4)
 - Brackets (2)
 - Back strap (1)

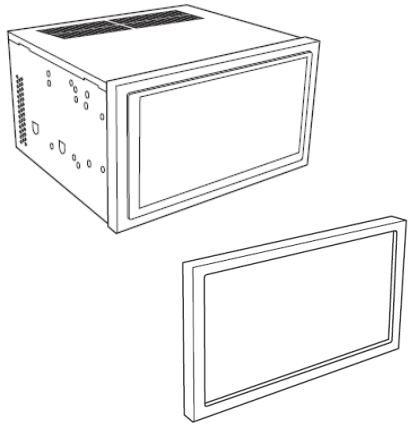

Connections

- Qty 1 Power/Speaker Harness
- Qty 1 Hands-free Microphone
- Qty 1 Audio Pre-amp Harness
- Qty 1 External Source Harness
- Qty 1 SWC Plug

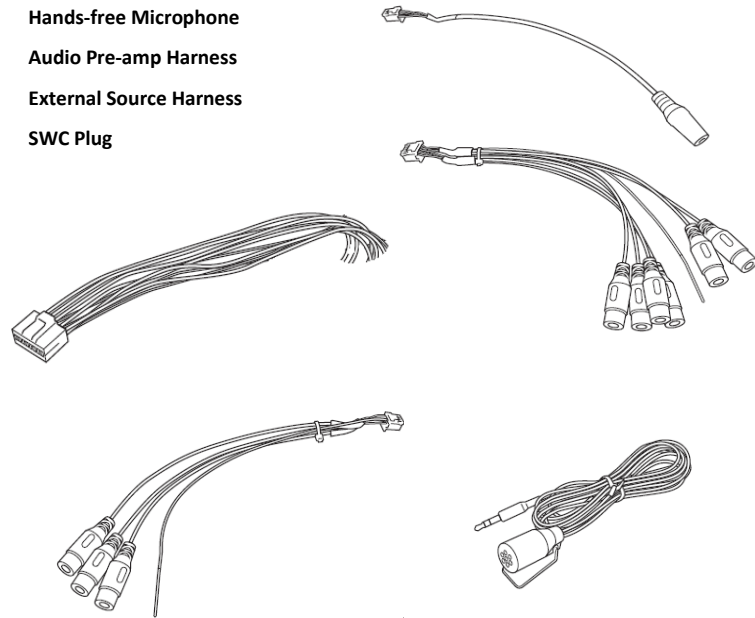

Basic Product Operation

Front Detail

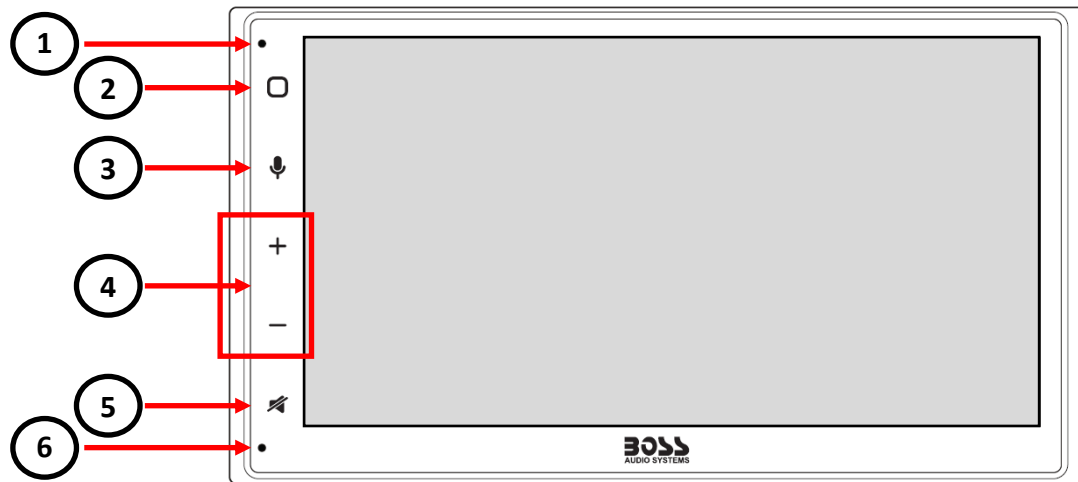

1 Microphone

2 Power/Home

3 Siri Button

4 Volume Control

5 Mute/Screen Off

6 System Reset

Basic Product Operation

Rear Detail

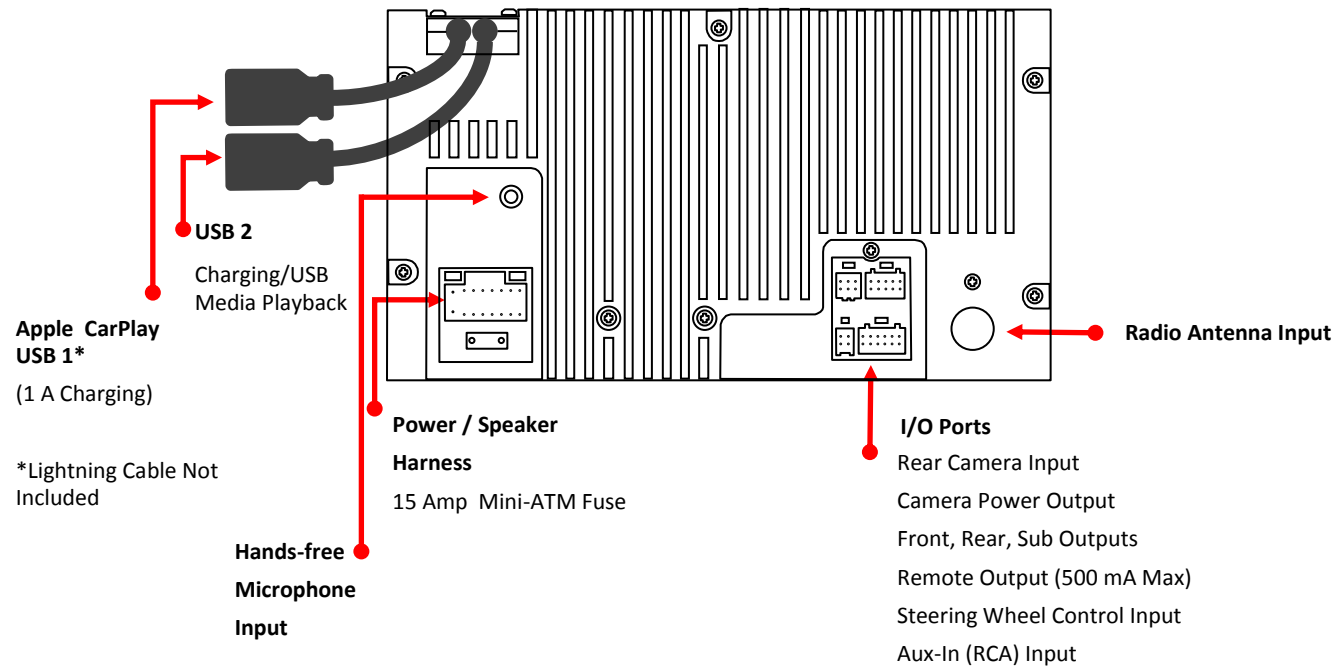

Basic Product Operation

Product Basics

Power On /Standby

1. **Touch** once to Power ON
2. **Touch and Hold** for Standby

NOTE

In **Standby Mode**, the LED will slowly pulse on and off.

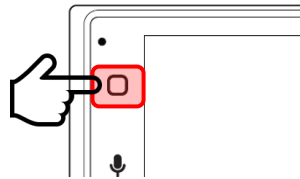

Volume

1. **Touch** once on either "+" / "-"
2. **Touch and Hold** for quicker operation

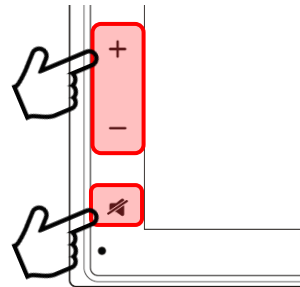

Mute

1. **Touch** to Mute

Siri

- Touch to command

NOTE

CarPlay must be active

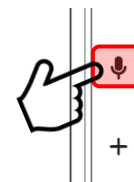

Display Off

- Touch and Hold Mute

Display On

- Touch the display to reactivate

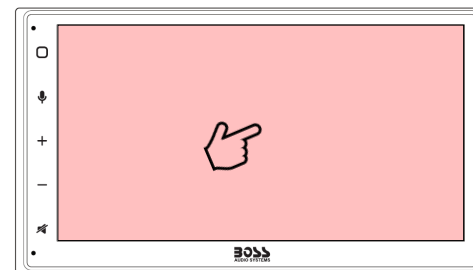
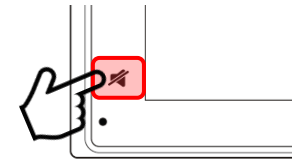

Basic Product Operation

Using and Caring for the Touchscreen

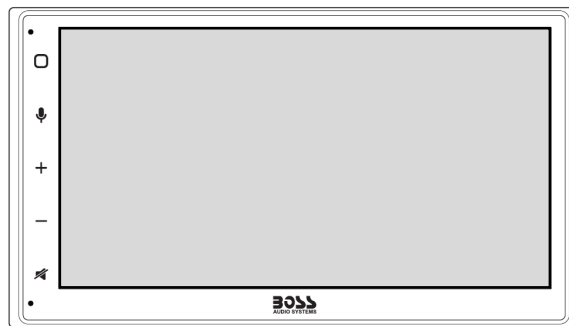

Use:

This head unit utilizes a Capacitive Touchscreen, the same type that is used on high-end mobile devices. It should be used for and cared for like that type of device. As with all capacitive type technology, if your fingers are wet or sweaty, it will not function properly.

Do not allow any sharp objects to come in contact with the screen glass.

Care and Cleaning:

To clean the screen, use a dry microfiber type cloth to clean. Do not use ammonia, window cleaner, or any other type of household chemicals to clean the screen. Abrasives should not be used at all.

Basic Product Operation

Product Setup (Date & Time)

Setup Option A: CarPlay Method

Connect your Apple® device using a Lightning® cable*. The CarPlay USB port must be used.

This will automatically setup the time and date.

User must set Time Zone manually.

Default is Pacific Time Zone

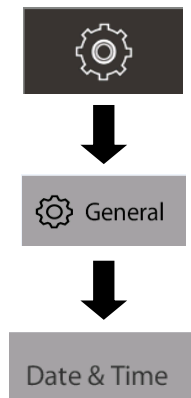

Setup Option B: Date and Time

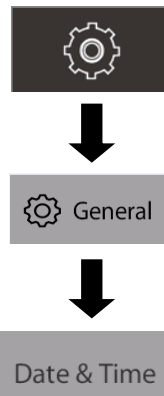

Additional Setup *pg. 26*

General > Language

Audio > EQ, Other Audio Settings

Display > Illumination, Brightness, LED

Steering Wheel Controls > Programming

Vehicle Specific Buttons

Basic Product Operation

Navigating the Menus

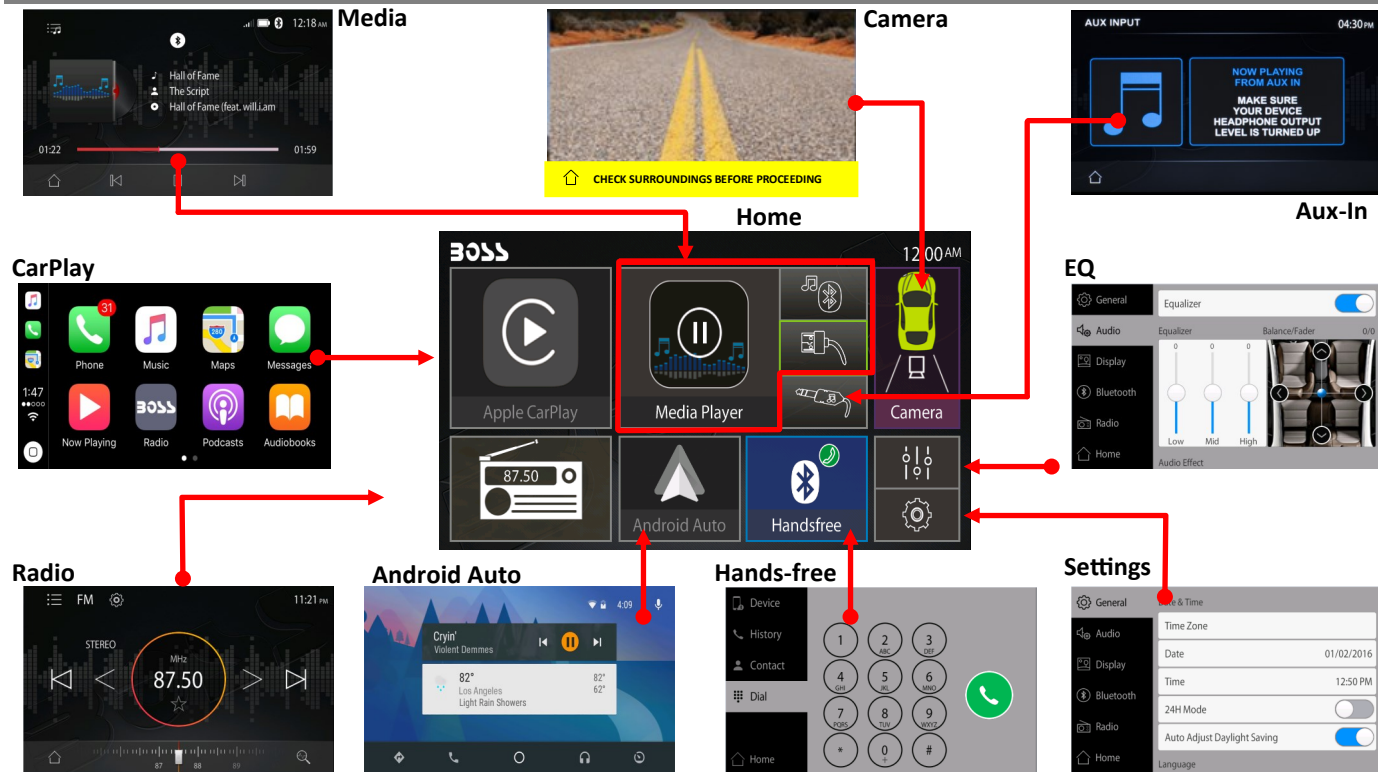

Apple CarPlay

Using CarPlay

Note

Apple CarPlay usage is limited while driving.

Functions, contents, and usability is determined by the App provider(s).

Controls will vary with each App that is available for CarPlay.

For more details visit:

<http://www.apple.com/ios/carplay>

WARNING

Familiarize yourself with your Local and State laws regarding mobile devices.

Certain functions of an iPhone might be prohibited and or illegal while driving in your location.

When in doubt, park the vehicle and engage the parking brake first before performing the function(s).

For other cautions and warnings see **pg. 9**

Connecting to CarPlay USB Port 1

1. Connect the CarPlay compatible device via Lightning® cable (not included).
2. The iPhone will load the CarPlay function.
3. On the display, the CarPlay will illuminate green, touch it to enter the CarPlay menu.
4. To return to the product Home menu,

Touch



NOTE

The product's Bluetooth will turn **OFF** automatically when CarPlay is in use. Hands-free phoning will function through the CarPlay feature.

When using CarPlay, there is no need to pair your iPhone, the USB cable connected through the USB Port (1) will enable this feature.

If other devices are connected via Bluetooth, they will be disconnected for the duration of CarPlay use.

Gestures & Control

Basic controls, but not limited to:

Touch



Swipe



Dragging



Other gestures and controls might differ on each App.

NOTE

Volume control is handled exclusively by the product.

See **pg. 13** for volume.

Apple CarPlay

Using CarPlay

CarPlay Display Setup

1. Using your iPhone:

Settings > General > CarPlay

2. **Touch and Hold** each App icon to move.

To remove an App, **Touch** 

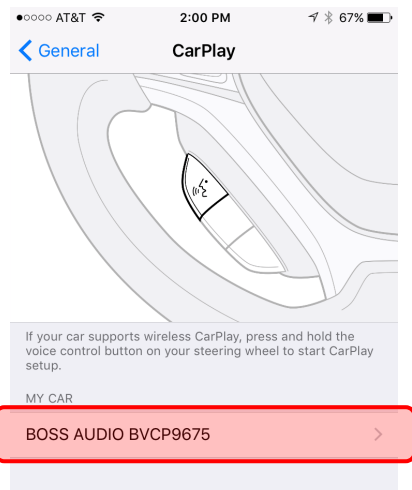

NOTE

Only Apps with the  icon can be removed from CarPlay.

To **Disable** other Apps see [pg. 18](#)

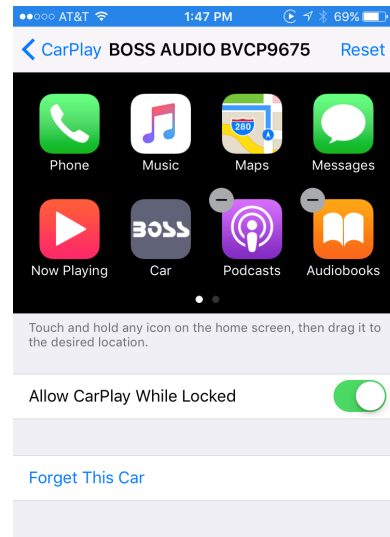

How to Disable Apps

1. Using your iPhone:

Settings > Notifications > App to Disable

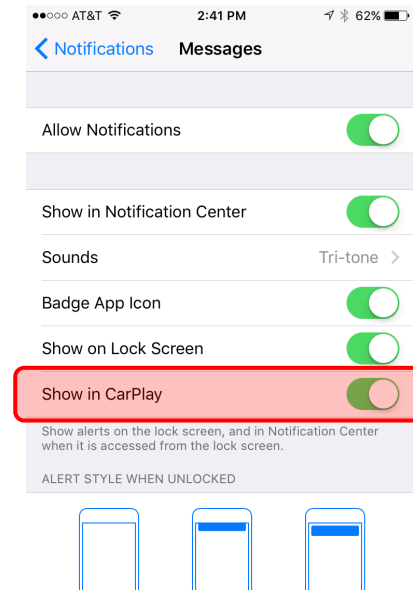

Android Auto

Using Android Auto

Note

Android Auto usage is limited while driving. Functions, contents, and usability is determined by the App provider(s).

Controls will vary with each App that is available for Android Auto.

For more details visit:

<https://www.android.com/auto/>

WARNING

Familiarize yourself with your Local and State laws regarding mobile devices.

Certain functions of the mobile device might be prohibited and or illegal while driving in your location.

When in doubt, park the vehicle and engage the parking brake first before performing the function(s).

For other cautions and warnings see *pg. 9*

NOTE

To complete the setup properly, the Parking Brake status wire must be connected. See *pg. 38*

WARNING

For your safety, the setup process **MUST** be accomplished while the vehicle is **Parked and Parking Brake Engaged**.

Android Auto App

1. Using your Android device, download the **Android Auto** app on Google Play.



Minimum Requirements:

Android 5.0 Lollipop

For a list of compatible devices:

<https://www.android.com/auto/>

Updating Related Apps

1. During the first start up and setup of the Android Auto app, the Maps, Music, Google apps will install/update automatically.

Connecting to Android Auto USB Port 1

1. Connect the Android compatible device via the appropriate USB cable (not included).
2. The Android device will load the Android Auto function.
3. Bluetooth will connect automatically when the setup is completed.
4. To return to the product **Home** menu,

Touch

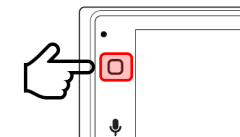

Android Auto

Using Android Auto

Android Auto Permissions

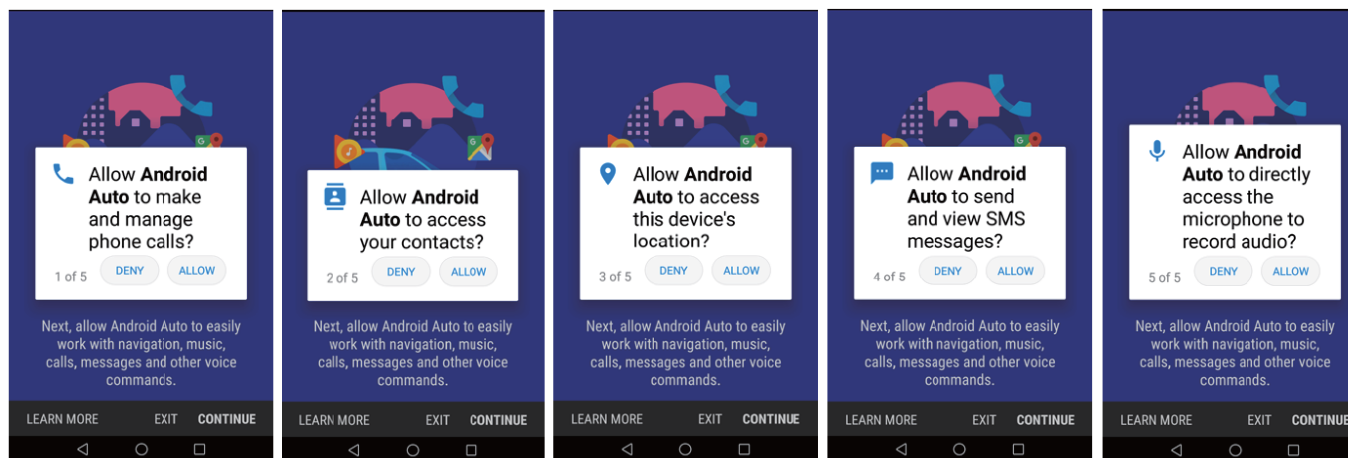

Permissions

Several features can be allowed or denied access to customize your usability of the product.

The access can always be modified in Settings on the Android device.

Bluetooth®

Setup & Connection

Hands-Free Menu

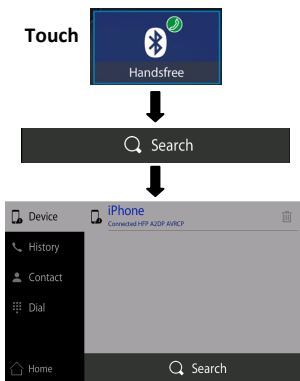

NOTE

CarPlay must not be active. If being used, disconnect the iPhone to start Bluetooth.

Compatibility with all mobile devices is not guaranteed. Please read through the user's guide of the mobile device.

CAUTION

For your safety, the setup process should be accomplished while the vehicle is parked and parking brake engaged.

First time Pairing

Navigate to the Hands-free menu ([pg. 16](#))
Touch **Search** to begin searching for devices

Mobile Device:
Search for **BOSS AUDIO BVCP9675A**
iOS Devices: **Settings > Bluetooth**
Android Devices: **Settings > Connections > Bluetooth**

A passcode is generated and will display on both the head unit and mobile device for secure pairing.

Touch  **YES** to confirm

Every time the product is powered ON, the mobile device will automatically connect if within range.

NOTE

Once paired and connected, the device list will display the available Bluetooth profiles.



Phonebook and History

To **Download Phonebook**:

1. Touch **Contact > Download**

Contacts will always be stored once downloaded

To **Download History**:

1. Touch **History > Download**

History will not be stored the product is powered off.

Device Status

Battery and Cellular Strength is displayed on the top right of the Home menu.

GATT Profile support is required on the mobile device.



Bluetooth®

Hands-Free

Calling

Making & Receiving Calls

1. Dialing from the dial pad

Touch  to make call

2. Contacts

Touch the contact name 

3. History

Choose the name, then

To End a call Touch 

To Mute a call Touch 

Dial pad

To use the dial pad while on a call

Touch 

Searching History

Swipe Up or Down to search



History

1. Outgoing Call 

2. Incoming Call 

3. Missed Call 

Private Mode

When a call needs to be transferred to the mobile device:

Touch  to switch the mobile device

Touch  to return to hands-free mode

Searching Contacts

Contacts must be downloaded to search.

1. Touch 

2. Enter the Contact Name, then

Call Waiting

To accept another call:

Touch 

To toggle between calls:

Touch

Note

Active calls will be illuminated green

To End a call, Touch 

Default Settings

Auto Connect: **ON**

Auto Answer: **OFF**

Auto Download Phonebook: **OFF**

First Name First: **ON**

Device Name: **BOSS AUDIO BVCP9675A**

For all settings see [pg. 26](#)

Bluetooth®

Audio

Audio Streaming

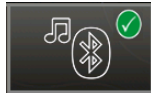

To play media through Bluetooth, the mobile device must be **Paired and Connected** to the BVCP9675A, see **pg. 22**.

1. **Touch**



The music will play automatically.

Track Control

1. Play/Pause 
2. Track Fwd / Rev 
3. **Swipe** to Fwd/Rev 

i NOTE

Profiles required for audio playback and control on the mobile device:

A2DP (Advanced Audio Distribution Profile)

AVRCP (Audio Video Remote Control Profile)

Media Player (Bluetooth)

Playback access is also available through the Media Player

1. **Touch**

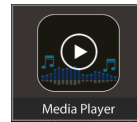

i Note

For best performance, your mobile device volume setting should be set to maximum.

All volume adjustments for the system should be controlled from the product.

The unit will recall the last volume setting on your mobile device every time it connects.

Formats

Playback is supported from the mobile device with any format it can play.

Audio will only be played by the product.

Video cannot be viewed on the unit.

Switching Media

- Touch 

Available sources will display **(Bluetooth and USB)**

i Note

USB source will only be displayed if a USB drive is inserted and has playable media.

Display

Track info will be displayed when available.

Track, Album and Artist.

Album art is not supported via Bluetooth playback.

Media

USB

USB Playback



The music will play automatically.

Audio & Video Control

1. Play/Pause 
2. Track Fwd / Rev 
3. Repeat List 
4. Repeat File 
5. Random 

Note

If there are other files in the USB, music files will play first.

Navigating Menu

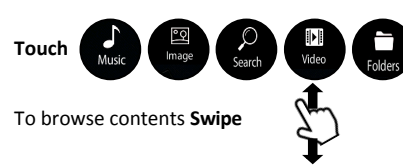







To return to the current file playing,



If no interaction, it will return after 25 sec to Media Player

Photos

1. Play/Pause 
2. Fwd/Rev 
3. Rotate 
4. Zoom   Swipe
5. Select Files 
6. Apply as splash screen 

WARNING

Watching videos or photos while driving is against Federal, State, and Local laws.

Do not use features of this product if it cannot be operated safely and legally in your location.

Note

Review the connections of this product, to properly integrate the parking brake wire to the vehicle.

Video and or photos cannot be viewed while driving. The vehicle must be stationary and the parking brake applied to enable viewing.

Radio

AM/ FM

Controls



Tuning

To search for stations:

Search

Touch and Hold < >

Manual Seek

Touch < >

Note

RBDS info (if available) and currently tuned station will display on the radio icon in the home screen

Not all stations will have or display RBDS info.

Station Listings

Bands

Settings



Swipe to quickly tune

Auto Search & Store

Band & Settings

Touch FM to switch bands

To change radio settings

Touch

For all Settings, see [pg. 28](#)

Favorites and Presets

Settings Favorites

Touch Favorite Set

To remove a favorite, Touch

Browsing Favorites

Touch

To return the Tuner screen Touch

Changing Presets

Touch

To list all Stored Stations

Touch

Aux In/Camera

External Source

Playback (Audio Only)

Touch



Media must be controlled from the external device.

Track functions are not controlled from the product.

Connections

For wiring connections see, [pg. 33](#)

Volume

See [pg. 13](#)

i Note

To adjust the volume level properly, the carry-in device volume should be set between 50% - 75%. The volume level should remain at that level for the remainder of the time it is connected to the product.

! WARNING

Never rely solely on the rear view camera; always check your surroundings before proceeding.

Images may appear reversed

Do not use features of this product if it cannot be operated safely and legally in your location.

Rear View

The rear view camera can be displayed on demand.

Touch



To return to the Home screen

Touch



i Note

The **Camera Trigger Output** wire must be connected for Camera source to function.

For wiring connections, see [pg. 33](#)

Reverse View

When the vehicle is put into reverse gear, the camera will display the image on the screen.



Rear View Delay

Due to varying vehicle configurations, the rear view trigger can be delayed to best suit the vehicle.

See [Settings pg. 26](#)

Default setting: **0 Sec** Delay

i Note

The rear view camera will still function normally, if the product is in standby mode

Audio

Adjustments

EQ

To access the EQ menu



To turn **ON** the EQ



To adjust the EQ bands

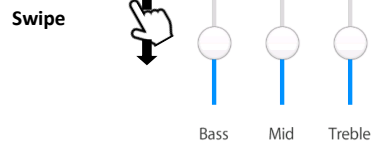

The center frequency of the each band can be changed: ± 7 dB

Bass Center Frequency	100Hz
Middle Center Frequency	1000Hz
Treble Center Frequency	10.0KHz

Note

The EQ can also be directly accessed while changing the volume. The volume display will show the EQ icon, you can touch to access the Audio Settings.





Preset EQ

Classic, Pop, Rock, Jazz

Balance/Fader

Left/Right Balance, Touch 

Swipe for quick adjustment 

Front/Rear Fader, Touch 

Swipe for quick adjustment 

Key Beep



Internal Amp

To reduce the possibility of noise entering the signal chain when utilizing the audio pre-amp outputs, the internal amp can be turned **OFF**



Loudness

Enhances and gently boosts low and high freq.



Subwoofer

The level and filter can be adjusted for the Sub pre-amp output.

Level, 0-14 dB

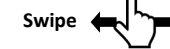

Filter: 80 Hz, 120 Hz, 160 Hz @ 12dB/Oct

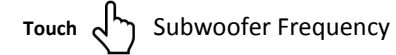

Volume

Settings are for default volumes for Hands-free.

Media Player is a global setting for media.

Settings

General

Date & Time

Time Zone

Adjust to correctly display time

Default Setting: (GMT-08:00) Pacific Time (US)

Date

Touch 

Time

Touch 

24H Mode

Touch 
OFF ON

Auto Adjust Daylight Saving

Touch 
OFF ON

Note

If using an CarPlay, the iPhone will automatically set date & time. Time Zone needs to be adjusted manually.

System Language

Touch to change

English (Default), Spanish

Note

CarPlay is independent of the system language setting.

User Interface

Background Picture

Touch to change

User can change the background picture by inserting a USB with photos.

Background Brightness

Swipe 

Rear View Settings

Touch 

0 Sec (Default) , 0.1 Sec, 0.5 Sec, 1 Sec, 2 Sec

When switching from Park to Drive, or vice versa, the camera should not trigger on the display.

Sensitivity should be adjusted to trigger only on reverse gear selection.

Power Off Delay

Touch 
OFF ON

Some vehicles during crank to start will interrupt the accessory power.

If the product re-boots during crank to start, Turn ON delay

The delay is 3 sec.

Default Setting: OFF

Note

Power Off Delay ON will also delay when the vehicle is turned OFF.

This might affect hands-free functionality during a call.

Factory Settings

To restore settings to default:

Touch 

CAUTION

Will restore all settings to factory defaults.

All settings and presets will be lost.

Settings

Display

Blur Effect



Menu to menu animation adds a blur effect

Illumination Control



When the vehicle lights are on, the products illumination can be customized for night use.

Screen and LED Brightness settings for this feature see [pg. 27](#)

See Connections [pg. 30](#)

Gamma



Gamma can be adjusted for both day and night settings.

Screen Brightness



LED Touch Buttons



Six preset colors can be chosen for Touch buttons, or chose below...

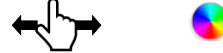

LED Brightness

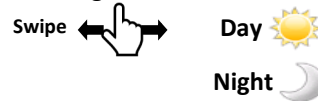

Animation Effect



Will cycle through all colors on LED touch buttons.

Default Setting: **ON**

Illumination Default

To restore Illumination Settings to Default



Will restore all Display settings.

Bluetooth

Bluetooth



Power On/Off Bluetooth

Default Setting: **ON**

Note

Bluetooth will turn **OFF** automatically when CarPlay is in use. If other devices are connected via Bluetooth, they will be disconnected for the duration of CarPlay use.

Auto Connect



Auto connects to the device when the product is powered ON

Default Setting: **ON**

Auto Answer



Auto answers when there is an incoming call.

Default Setting: **OFF**

Settings

Bluetooth

Phonebook Download



Automatically downloads contacts

Default Setting: **OFF**

First Name First



First name is displayed. If last name is to be displayed first, turn off.

Default Setting: **ON**

Device Name

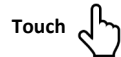

BOSS AUDIO BVCP9675A

The friendly name can be changed to display on the mobile device.

Radio

Seek Quality FM/AM

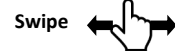

Adjusts the sensitivity of both AM/FM bands

Reset



Will reset the seek sensitivity to back to default

Region

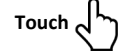

Default Setting: **America 2**

US Tuner Spacing: FM (200 KHz), AM (10 KHz)

European Spacing: FM (50 KHz), AM (9 KHz)

RBDS, Radio Broadcast Data System

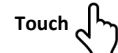

Default Setting: **ON**

Allows data from the radio station to be displayed on the product.

RBDS, Cont'd

Not all stations will broadcast information to display.

AF (Alternative Frequency)



When **On**, the tuner will automatically locate the same tuning program on other stations and select the strongest signal of those being broadcast.

Default Setting: **OFF**

TA (Traffic Announcement)



The radio will automatically tune in to traffic information broadcasts while receiving FM broadcasts playing media.

Default Setting: **OFF**

Settings

Steering Wheel Controls

Programming Functions



To program the SWC buttons from the vehicle



1. **Touch** the Button to be programmed, the corresponding Steering Wheel Button.
2. Once programmed, the setting will illuminate, confirming the successful programming.
3. Repeat the process until all desired buttons have been programmed.
4. **Touch** 

Reset SWC

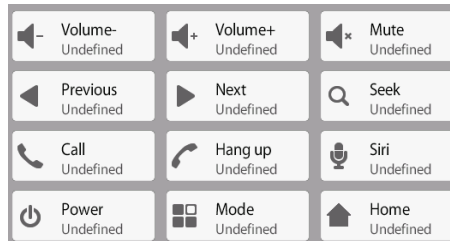

Note

For connection details, see **pg. 34**

About

Displays the system information:

Operating System

Software Version

MCU Version

Hardware Version

Hardware ID

CarPlay MAC Address

Connections

Power

CAUTION

It is recommended to have the product installed by a certified installation professional.

CAUTION

Before installation, or wiring connections, disconnect the negative (-) battery terminal to prevent damage to the product, and/or possible injury.

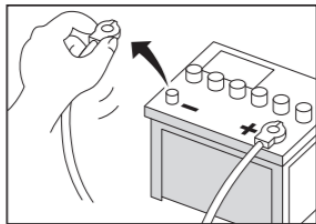

Note

When replacing the fuse, always do so with the same type and value (15 A).

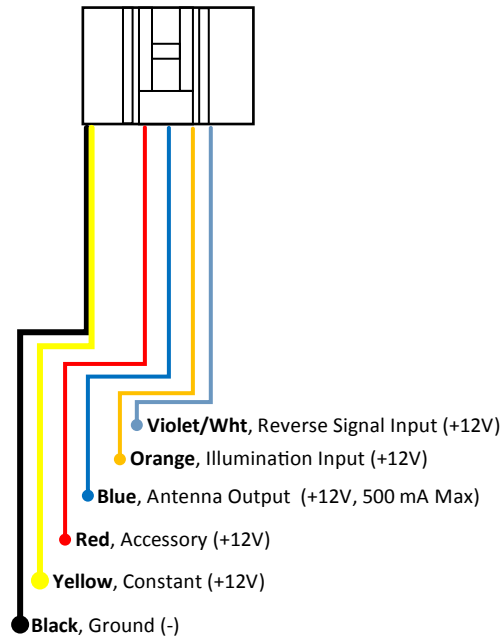

Note

Unused input/output wires need be insulated with tape, heat shrink, or crimp connectors. **Never use wire nuts.**

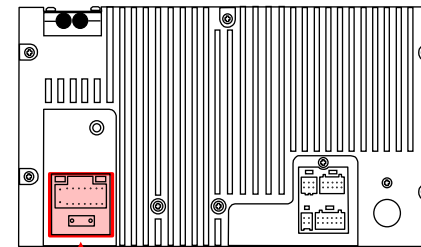

Connections

Speakers

CAUTION

Do not chassis ground any speaker wire leads.

CAUTION

Only use 4-8 Ω Speakers

Do not use 1-3 Ω Speakers

CAUTION

Do not bridge any of the channels, they are only to be wired in stereo mode.

Note

Unused speaker wires need be insulated with tape, heat shrink, or crimp connectors.

Never use wire nuts.

If the speaker outputs are not used, turn **Off** the internal amp to reduce the possibility of noise entering the signal chain.

See *pg. 25*

Note

Observe speaker polarity when making connections.

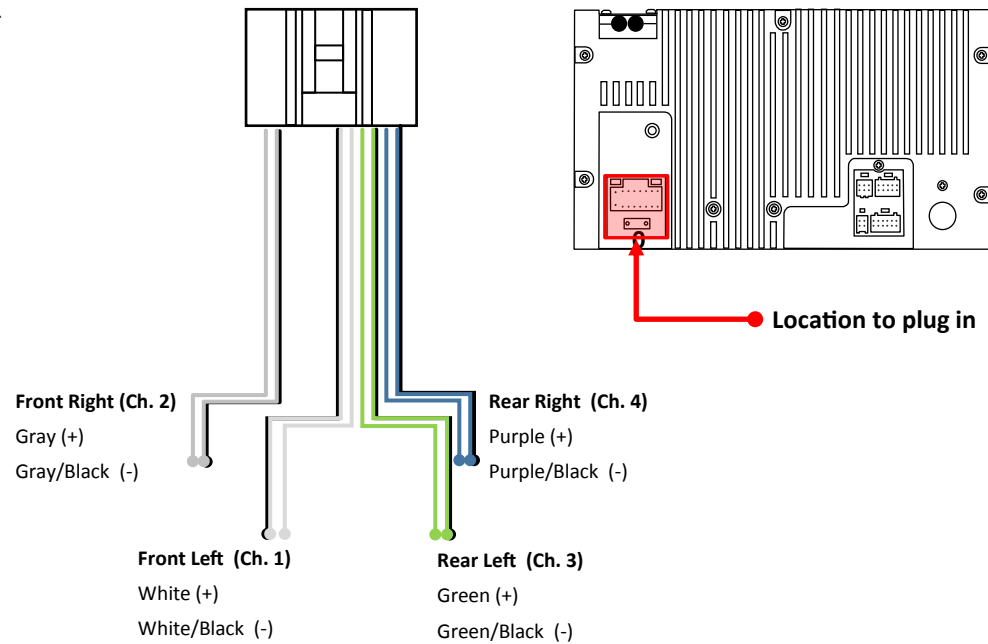

Connections

Audio Pre-amp

CAUTION

Remote Out is 500 mA max output rating. If several amplifiers are to be used, it is recommended to use a relay for the Remote Out trigger.

Note

Subwoofer Pre-amp is a non-fading mono output.

Note

Always run signal wires away from power cables to reduce the possibility of noise.

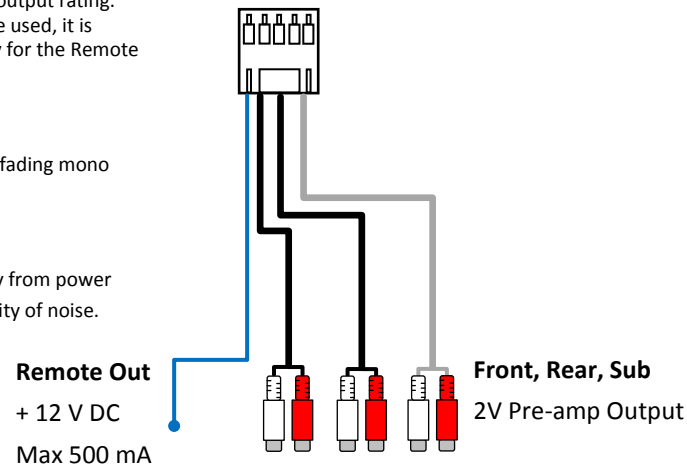

Note

If pre-amp outputs are being used exclusively, turn **Off** the internal amp of the product, to reduce the possibility of noise entering the signal chain.

See *pg. 25*

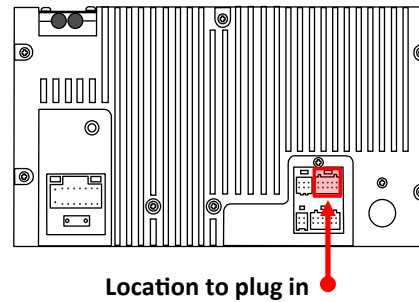

Connections

Camera & Aux In

! WARNING

Never rely solely on the rear view camera; always check your surroundings before proceeding.

Images may appear reversed

Do not use a feature of this product if it cannot be operated safely and legally in your location.

i Note

Camera power is required for **Camera** source to function.

The product will power **On** the camera from the *Camera Power Output* when the reverse signal is triggered.

See *pg. 24*

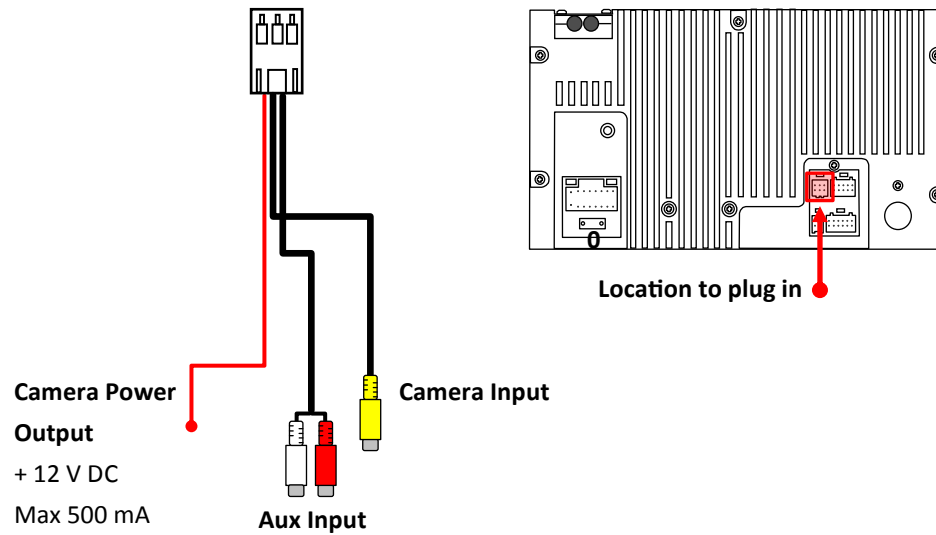

Connections

Steering Wheel Controls

SWC Input

Up to 12 Buttons can be programmed.

See *pg. 29*

i Note

A separate interface might be needed for your vehicle application. It is recommend that you consult with a professional installer.

SWC Input



Key 1 (Tip) → GND (Ring)

SWC Interface
(Not Included)

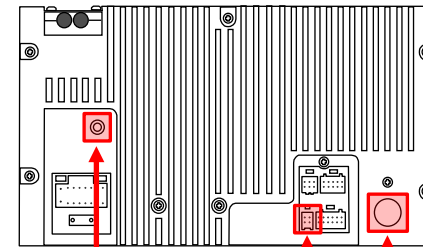
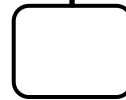

Mic Location

SWC Input

AM/FM Ant. Input

Connections

USB

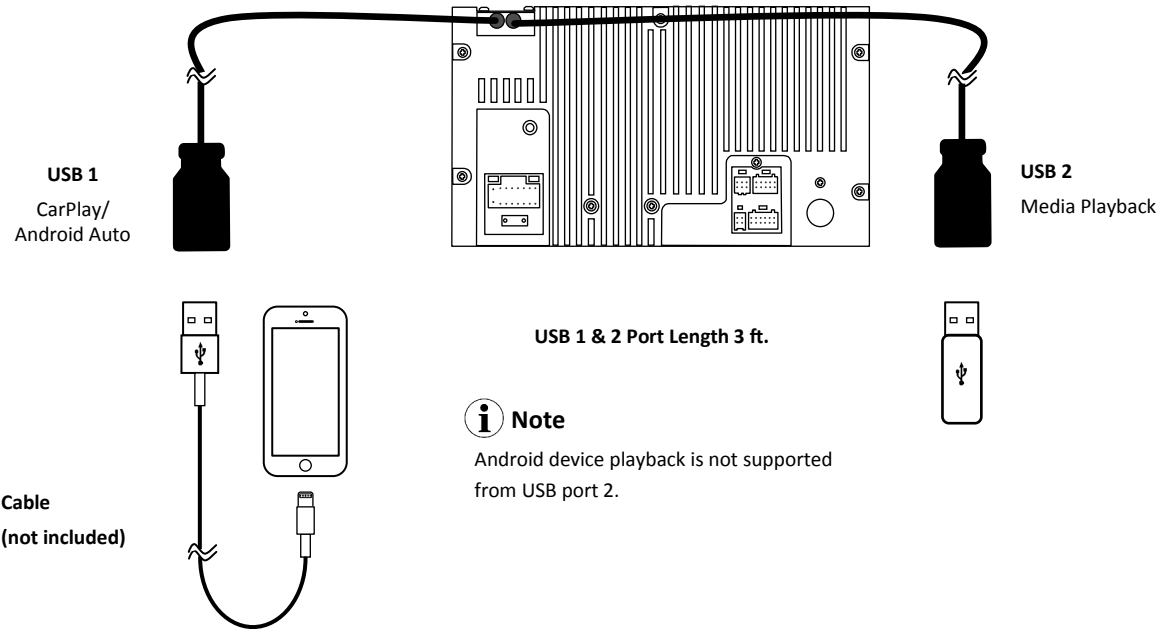

Connections

Parking Brake

WARNING

Improper connection or use of the parking brake status wire, (i.e. defeating the safety feature) violates Federal, State, and Local laws. This may lead to injury, property damage, and/or death.

WARNING

Watching videos or photos while driving is against Federal, State, and Local laws.

Note

For Android Auto setup, the parking brake status wire **MUST** be connected.

Note

Review the connections of this product, to properly integrate the parking brake wire to the vehicle.

Video and or photos cannot be viewed while driving. The vehicle must be stationary and the parking brake applied to enable viewing.

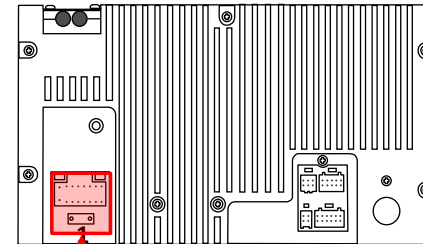
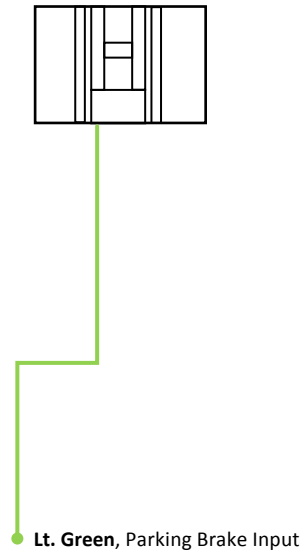

**Power/Speaker
Harness**

Note

The parking brake input needs to be connected to the power side of the parking brake.

Note

Every vehicle has a different type of parking brake connection; consult a certified professional installer.

Connections

Hands-free Mic

Placement

Every vehicle will perform differently due to layout, interior materials, etc...

The **Red** shaded areas are the recommended locations for best microphone performance.

Items to look for before placement:

1. Do not place in front of air vents.
2. If the vehicle has tweeters placed on sail panels, do **NOT** locate the mic on steering column area.
3. Front of mic must not be blocked.
4. Mic should be firmly attached to mounting location.
5. Do not cover the grille openings surrounding the mic.
6. To avoid excessive wind noise, do not place near the sunroof opening

WARNING

Run microphone wire where it will **NOT** impede the operation of any safety items, i.e. Airbags, Knee Airbags, etc...

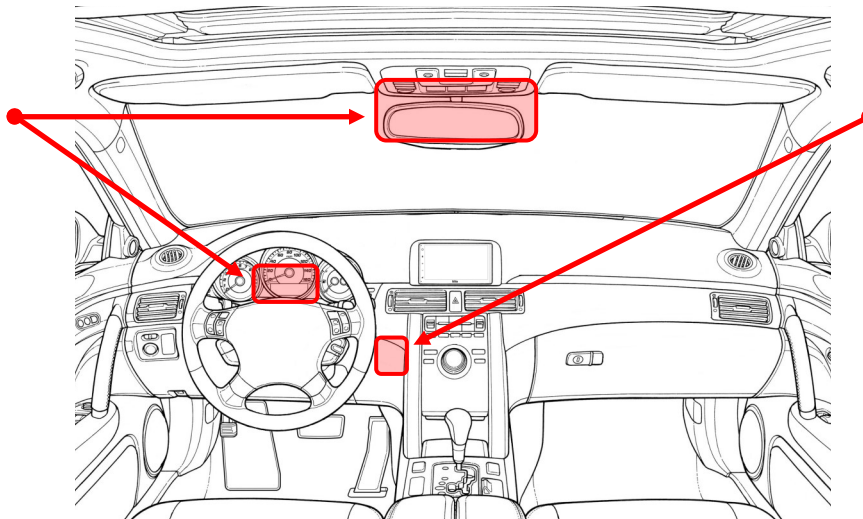

Troubleshooting

Issues	Cause	Solution
No Sound	Internal amplifier is off Product is muted External amplifiers Audio source	Go to Settings > Audio > Internal Amp ON Touch the volume. Check the external amplifiers are on. Check the remote output wire has voltage Change the audio source
Media Not Supported	Media on USB flash drive	Change the media format on the USB device Change the USB device
Bad Radio Reception	Radio area Antenna	Go to Settings > Radio > Sensitivity Adjust AM/FM Sensitivity Change the station Turn OFF AF and TA Turn OFF RBDS Antenna output wire isn't connected Connect Antenna to product see pg. 34
Apple CarPlay/Android Auto will not start	Bad Lightning®/USB cable Locked device Not charged CarPlay/Android Auto frozen	Replace the cable Device needs to be unlocked Device needs to be powered ON for CarPlay/ Android Auto to function. Allow it to charge and power on. Unplug the device, close all Apps and plug it in again.
Bluetooth	Not connecting to device	Make sure the device is within range. Devices' Bluetooth connection needs to be turned ON

Troubleshooting

Issues	Cause	Solution
Bluetooth	Not connecting to device	Go to Settings > Bluetooth > Power ON Pair and Connect the device like new.
Hands-free call quality	Mobile device Microphone	Check cellular strength on mobile device. End call and redial number. Microphone placement needs to be relocated. Microphone needs to be firmly attached to location it's mounted on. Check to see if microphone is properly plugged in.
Unit is unresponsive	Processor has frozen	Press the RESET button on the front panel See pg. 11



If you have questions about this product:

Customer Service

805-751-4853

M-F 8:30a-5:00p (PST)

Tech Support: www.bossaudio.com/support/technical-support

© 2017 Boss Audio Systems

BVCP9675A_1117

Specifications

General

Power Input.....10.8 V—16 V DC
 Nominal.....14.4 V DC
 Current Consumption.....10 A (Max)
 Fuse Type.....10 A, Mini-ATM
 Dimensions (H x W x D).....4" x 7" x 6.5"
 Unit Weight.....3.1 lbs.
 Operational Temperature.....-4—158°F

Display

Screen Size.....6.75"
 Aspect Ratio.....16 x 9
 Resolution.....480 x 800
 Screen Type.....TFT-LED Active Matrix

Audio

Max Power.....80 W x 4 Ch.
 Acceptable Speaker Load.....4-8 Ω
 Preset EQ.....4
 EQ Bands, Adjustable.....3
 Bass.....60,80,100,200 Hz
 Mid.....500 Hz, 1, 1.5, 2.5 kHz
 Treble.....10, 12.5, 15, 17.5 kHz
 EQ Boost/Cut.....± 7 dB

Audio Cont'd

Pre-amp Output.....3 Pairs
 Front.....2V, Full-Range
 Rear.....2V, Full-Range
 Sub (Mono).....2V, LPF
 Sub LPF.....80 Hz, 120 Hz, 160 Hz @ 12dB/Oct
 Sub Level.....+1-14dB

Radio Tuner

Freq. Range.....87.5 MHz-108 MHz (FM)
 Freq. Range.....522 kHz-1710 kHz (AM)
 America Range (FM).....100 kHz Spacing
 America 2 Range (FM).....200 kHz Spacing
 Europe Range (FM).....50 kHz Spacing
 RBDS.....AF, TA
 S/N Ratio (FM).....60 dB (Analog Broadcast)
 Sensitivity.....10 dB
 S/N Ratio (AM).....45 dB (Analog Broadcast)
 Sensitivity.....30 dB

Apple CarPlay

iPhone Support.....iPhone 5 or Newer
 iOS.....iOS 7.1 or Newer

Android Auto

Supported.....(5.0) Lollipop or Newer

USB

USB Spec.....USB 2.0 (High-Speed)
 USB Current Output.....1.5 A (Max)
 File System.....FAT32
 Audio Playback.....WAV, MP3, WMA, APE, FLAC, OGG
 Video Playback....AVI, OGM, MKV, MOV, WMV
 Picture Playback
 JPG, PNG, BMP

Flash Drive Support.....up to 32GB

*Not all listed compressed files guaranteed to play due to different creation methods or file contents.

Bluetooth®

Version.....v3.0+E.D.R.
 Audio Codec.....S.B.C.
 Profiles.....
 A2DP v1.2, AVRCP v1.4, GATT v1.0, HFP v1.5, PBAP v1.0
 Output Power.....Class 2
 Up to 33 ft (10m), Free-range

User's Notes