

COSCO[®]
solid value | smart design

COSCO[®]
solid value | smart design

www.coscojuvenile.com

Apt 40RF Convertible Car Seat

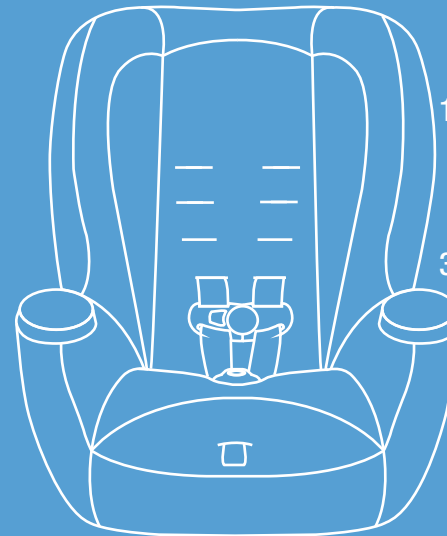

Rear facing:
5-40 lbs (2.3-18 kg)
19-40 in (48-101.6 cm)

Forward facing:
22-40 lbs (10.1-18 kg)
34-43 in (85.1-110 cm)

KEEP INSTRUCTIONS FOR FUTURE USE.
Read all instructions before using this child restraint.

4358-5768B



©2014 Cosco Management, Inc. All Rights Reserved.

⚠ WARNING:

Failure to follow the warnings on the labels and in the instruction manual can result in serious injury or death to your child.

A. Before You Begin.....Pages 3-8

- A-1 Thank You...
- A-2 Registration and Safety Notices
- A-3 Understanding Your Child Restraint

B. Safety Information..... Pages 9-10

- B-1 Vehicle Seating Position
- B-2 Installation in Vehicle
- B-3 Child Restraint Use

C. Basic UsePages 11-25

- C-1 Choosing Position for Your Child
- C-2 Preparing Child Restraint to Fit Your Child
- C-3 Securing Child in Child Restraint
- C-4 Removing Child From Child Restraint
- C-5 Removing Pad for Cleaning
- C-6 Installing Harness System
- C-7 Accessories on Select Models

D. General Vehicle InstallationPages 26-30

- D-1 Understanding Your Vehicle
- D-2 Vehicle Seating Position
- D-3 Choosing LATCH or Vehicle Belts
- D-4 Knowing Your Vehicle Belts
- D-5 Aircraft Information

E. Installing Rear Facing Pages 31-39

E-1 Preparing to Install Rear Facing

E-2 Preparing to Install LATCH Rear Facing

E-3 Installing Rear Facing with LATCH

E-4 Installing Rear Facing with Vehicle Belts



F. Installing Forward Facing Pages 40-48

F-1 Preparing to Install Forward Facing

F-2 Adjusting Top Anchorage Strap (Tether)

F-3 Preparing to Install LATCH Forward Facing

F-4 Installing Forward Facing With LATCH

F-5 Installing Forward Facing with Vehicle Belts



General Information..... Pages 49-56

- Using a Locking Clip
- Troubleshooting
- Warranty
- Replacement Parts Order Form

A-1 Thank You...

Thank you for choosing this car seat, referred to throughout this manual as a child restraint. The DJG family is committed to creating a child restraint with the most comfort and convenience available today.

Remember, parents are a child's first teachers and examples. If you always buckle your seat belt, your child will think it is the natural thing to do. Make it a firm rule that the vehicle does not go until everyone is buckled up. Make no exceptions.

No one can predict if use of a child restraint will prevent injury or death in a particular crash. However, combined with careful driving, proper use of a child restraint can lower a child's risk of injury or death in most crashes.

Your child's safety is worth the time it will take to read and follow these instructions. After reading, if you still have questions or have any concerns with this child restraint, please contact our Consumer Relations Department at:

Dorel Juvenile Group, Inc.

Website: www.djgusa.com
Fax: 1-800-207-8182
Mailing Address: Dorel Juvenile Group, Inc.
P.O. Box 2609
Columbus, IN 47202-2609
Telephone: 1-800-544-1108
8 A.M. to 6 P.M. EST M-TH
8 A.M. to 4:30 P.M. EST FRI

Para recibir las instrucciones en español, llame al 1-800-544-1108 o solicítase por escrito al dirección por arriba.

A-2 Registration and Safety Notices

Please complete the postage-paid registration card that came with your child restraint, and send it to us. Child restraints could be recalled for safety reasons. You must register this restraint to be reached in a recall. Send your name, address, email address if available, and the restraint's model number and manufacturing date to:

Dorel Juvenile Group, Inc.
PO Box 2609, Columbus, IN 47202-2609
Attn: Consumer Relations

or call 1-800-544-1108 or register online at www.djgusa.com/registration/carseat/us.

For recall information, call the U.S. Government's Vehicle Safety Hotline at 1-888-327-4236 (TTY: 1-800-424-9153), or go to <http://www.NHTSA.gov>

Consumer: Just fill in your name, address and email. Please print (use dark ink).

Your Name _____

Your Street Address _____

State _____ Zip _____

Address (optional) _____

Model Number: 22395-MCK

Manufacture Date: 10/26/2011

onBoard 36 air

L#10 B 187859

Example of model number and manufacture date.

If you don't have the card or if your address changes, you will find the model number and manufacture date on the label located on side of shell.

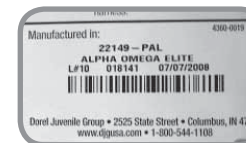

A-3 Understanding Your Child Restraint

Front View

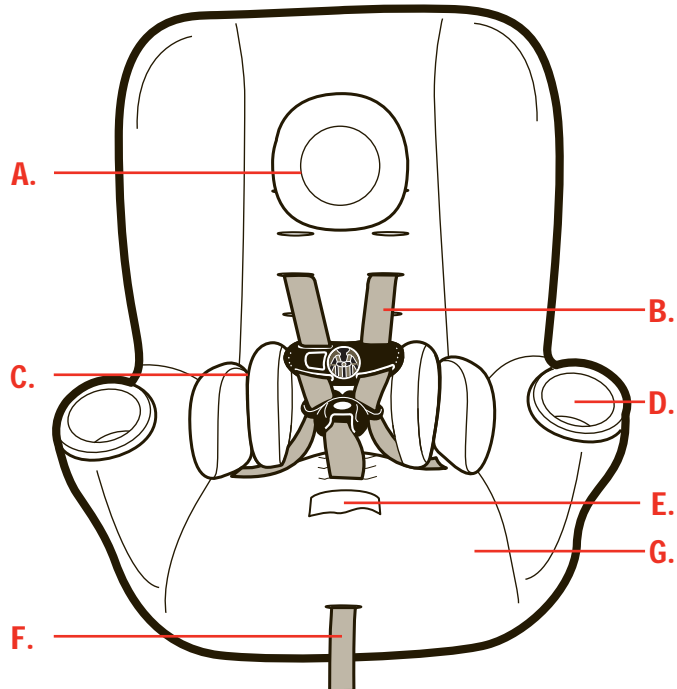

- A. Head Pillow**
(on select models)
- B. Harness System**
- C. Body Pillows**
(on select models)
- D. Cup Holder**
- E. Harness Release Lever** (under flap)
- F. Harness Tightening Strap**

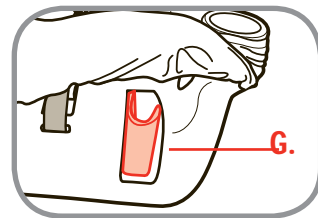

- G. Instruction Manual Storage** (under pad)

Pad layout may not be the same as shown. See section C-7 for other possible accessory options.

Harness System Detail

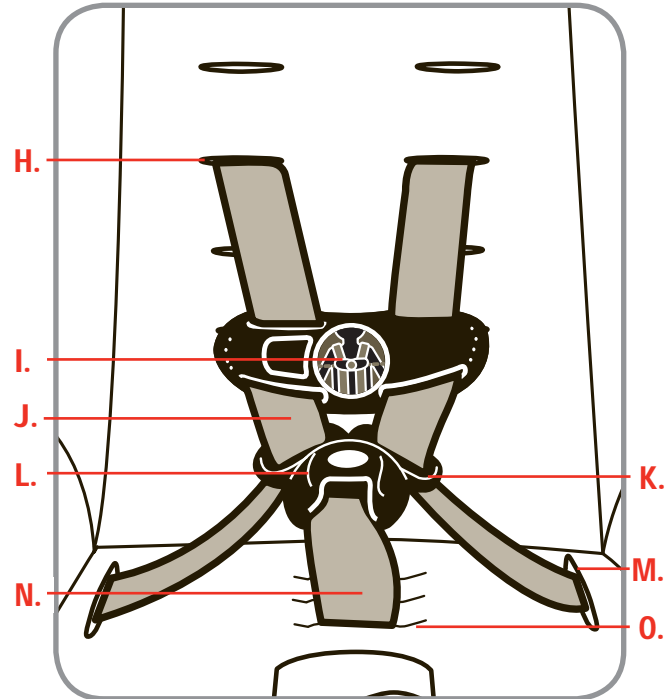

- H. Upper Harness Slots**
- I. Chest Clip**
- J. Harness Straps**
- K. Buckle Tongue**
- L. Buckle**
- M. Lower Harness Slots**
- N. Buckle Strap**
- O. Buckle Strap Slots**

A. Before You Begin

Back View

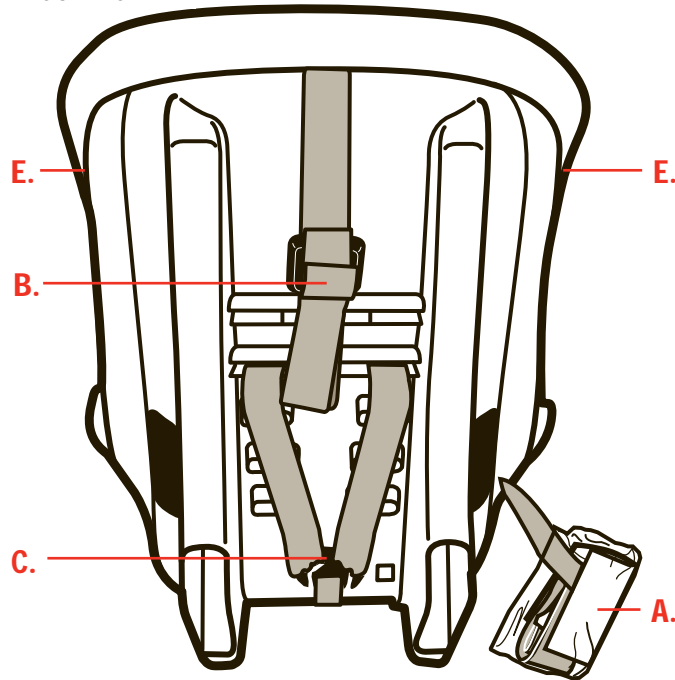

- A. LATCH**
(in plastic bag)
- B. Top Anchorage Strap (Tether)**
- C. Splitter Plate**
- D. Top Anchorage Strap (Tether) Storage**
- E. LATCH Storage**
(under pad on side of shell)

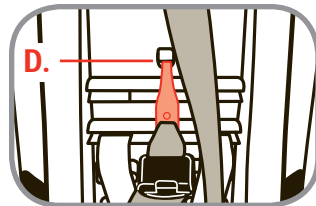

Side View

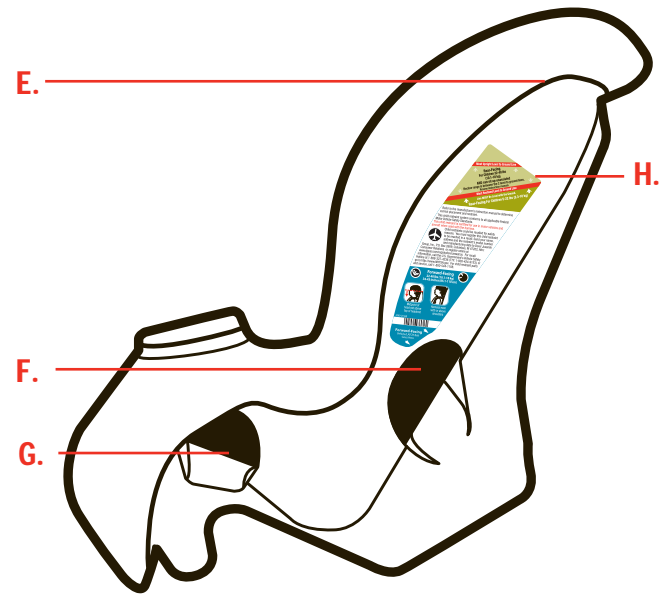

- F. Forward-Facing Belt Path**
- G. Rear-Facing Belt Path**
- H. Level to Ground Lines**

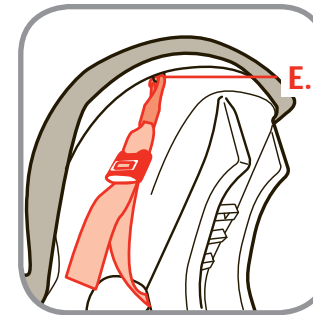

A. Before You Begin

⚠ WARNING:

Failure to follow these warnings can result in the serious injury or death of your child. To help you recognize instructions which are most critical to your child's safety, we use this symbol: ⚠

B-1 Vehicle Seating Position



⚠ Never place a child rear facing in a seating position with an active frontal airbag.

⚠ Check the vehicle owner's manual for more information about airbag/child restraint use.

⚠ For vehicles without a back seat, refer to your vehicle owner's manual.

B-2 Installation in Vehicle

⚠ Check the vehicle belt or LATCH belt before each use. Use only if the belt is tightened properly and securely.

⚠ This child restraint should be securely belted in the vehicle even when not in use. In a crash or sudden stop, an unsecured child restraint could injure occupants.

⚠ Do not use a child restraint that has been in a crash. You must get a new child restraint.

B-3 Child Restraint Use

⚠ Do not use this child restraint unless the child is 5-40 lbs (2.3- 18 kg) and 19-43 in. (48-110 cm).

⚠ Never take your child out of the child restraint while the vehicle is moving.

⚠ Never leave child unattended.

⚠ Placing your child in a hot child restraint may result in burns.

⚠ Do not use a child restraint with damaged or missing parts.

⚠ Do not use cut, frayed or damaged harnesses.

⚠ Do not lubricate buckles and fasteners.

⚠ Do not substitute parts or try to modify the child restraint in any way.

⚠ Do not use any child restraint accessory except those approved by Dorel Juvenile Group.

⚠ Never allow any child to play with this child restraint; it is not a toy.

⚠ Do not remove or cover up any of the warning labels or other labels on the child restraint.

⚠ Read all instructions for additional warnings.

⚠ On the back of the child restraint there is an expiration date for use of this child restraint. Do not use this child restraint after the expiration date.

C-1 Choosing Position for Your Child

Your child's height, weight and age determine how your child restraint should be placed in the vehicle.

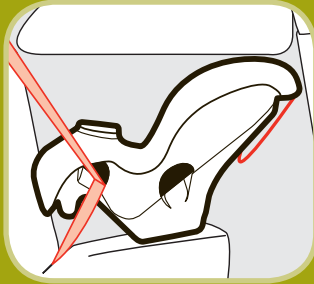

5-40 lbs (2.3-18 kg)
and 19-40 in.
(48-101.6 cm)

**Rear Facing using
5-point harness**
Child and child restraint
are placed in the back
seat, facing the back of
the vehicle.

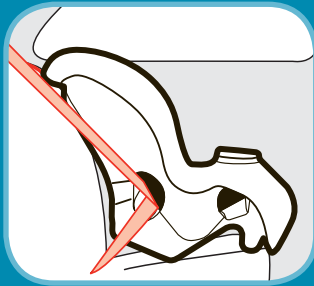

22-40 lbs (10.1-18 kg)
and 34-43 in.
(85.1-110 cm) and
at least 1 year old

**Forward Facing using
5-point harness**
Child and child restraint
are placed in the back
seat, facing the front of the
vehicle.

Safety Tip:

Experts agree that children should remain rear facing as long as possible. In this child restraint, your child can remain rear facing up to 40 lbs (18 kg) and up to 40 inches (101.6 cm).

C-2 Preparing Child Restraint to Fit Your Child

You **MUST** make these adjustments with your child before you install the child restraint in the vehicle.

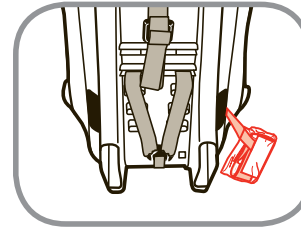

1. **Remove LATCH Belt
from Packaging**

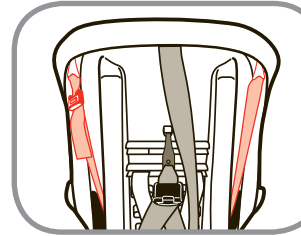

2. **Store LATCH**

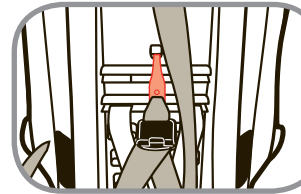

3. **Store Tether**

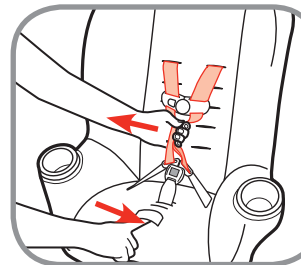

4. **Loosen Harness**

Push down on the harness release lever (under flap on the front of restraint) while pulling out on the harness.

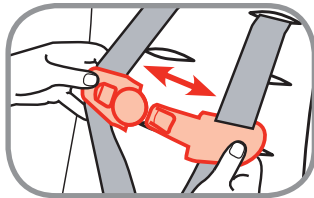

5. Release Chest Clip

Press on chest clip release button and pull apart.

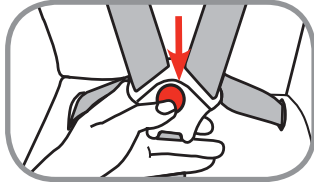

6. Unbuckle Harness

Press red button. Pull buckle tongues out. Place harness straps out of the way.



7. Place Child in Child Restraint

Place the child's bottom and back flat against the restraint.

This will allow the harness straps to be properly tightened.

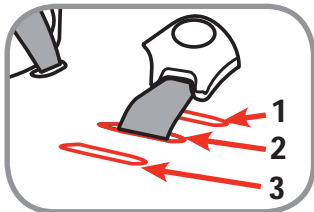

8. Check Buckle Position

Determine which of the available buckle positions will provide a snug fit for your child.

You **MUST** use the 1st or 2nd buckle strap slots when rear facing. Any slot can be used for forward facing.

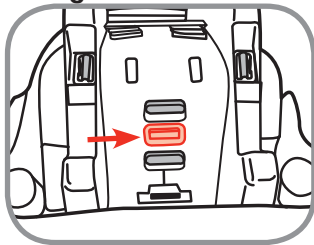

9. To Change Buckle Position

Turn the child restraint over and locate buckle's metal retainer on bottom of shell.

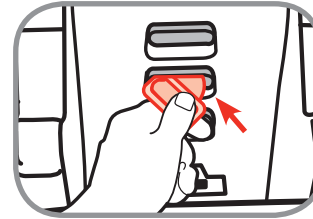

a. Rotate metal retainer, then insert retainer up through the shell and pad.

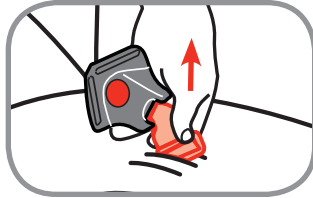

b. From the top, pull buckle free from shell and pad.

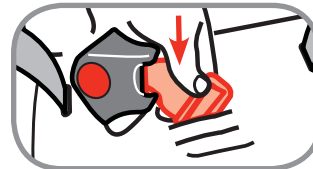

c. Insert the buckle's metal retainer through the desired slot.

Make sure that the buckle is **facing out**.

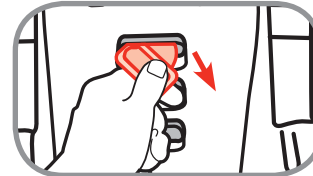

d. Pull buckle's metal retainer **completely** through pad and shell.

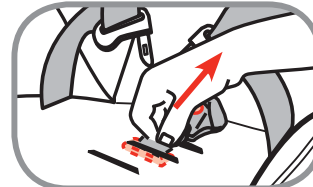

f. Pull up on buckle to make sure it is secured.

The buckle must not pull out.

C. Basic Use

⚠ WARNING:
Failure to place buckle's metal retainer completely through pad and shell can result in serious injury or death.

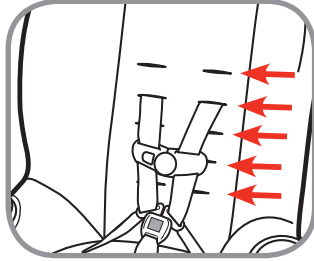

10. Check Harness

With child in the child restraint, check the location of the upper harness slot.

Follow the guidelines below to determine the correct harness height.



Rear-Facing Position

Upper harness slots must be **even with or just below** the shoulders.

If the lowest harness slot is above the child's shoulders, **do not** use this child restraint.



Forward-Facing Position

Upper harness slots must be **even with or just above** the shoulders.

If the highest harness slot is below the child's shoulders, **do not** use this child restraint.

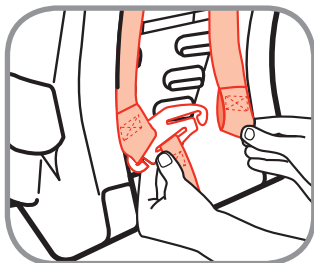

11. To Change Harness Location

From the back of the seat, remove harness from splitter plate.

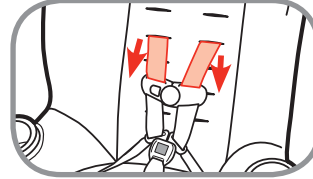

a. Pull Harness Out of Shell From the Front

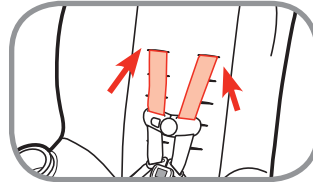

b. Rethread Harness Into Correct Harness Location

Make sure harness does not twist.

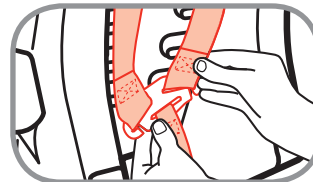

c. Attach Harness Straps to Splitter Plate

From the back of the child restraint, fit the harness strap loops onto the splitter plate.

Make sure sewn ends of the harness strap loops face towards you. **DO NOT** twist harness straps or harness tightening strap and make sure the harness straps are **COMPLETELY ON** the splitter plate.

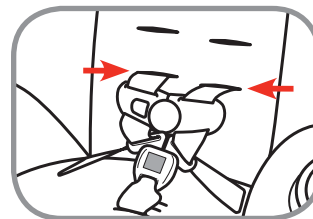

Using the Lowest Harness Slots

When using the lowest harness slots, you **MUST** move the harness's metal retainers to the inside position. This will allow a proper fit for the lowest harness slot use.

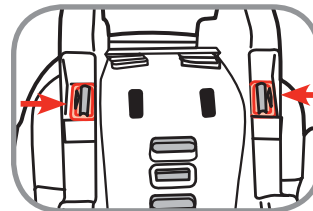

1. Rotate the child restraint over and locate both metal retainers.

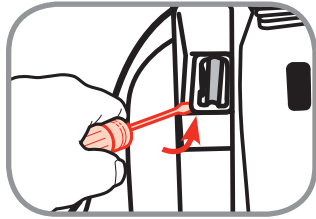

2. Use a flathead screwdriver and lift metal retainer off plastic tab.

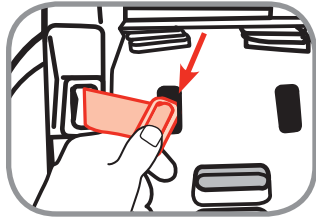

3. Pull harness and metal retainer out of the outside harness storage location. Insert the metal retainer into the closest slot as shown.

From the front, pull on the harness straps to make sure they do not pull out.

Repeat for other side.

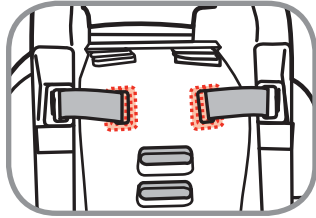

⚠ WARNING:



Do not use this child restraint rear facing if the top of your child's head is above the top of the child restraint.



Do not use this child restraint forward facing if the midpoint of your child's head is above the top of the child restraint.

Make sure the harness height is correct for your child's size.

Failure to follow these steps can result in serious injury or death.

C-3 Securing Child in Child Restraint



1. **Position Harness Straps Over the Child's Shoulders**

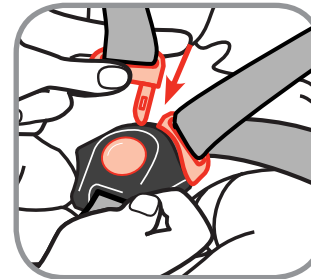

2. **Buckle Harness**

Push each buckle tongue into buckle until you hear a "click."

Pull up on harness straps to make sure buckle is locked.

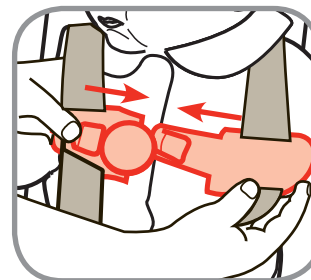

3. **Close Chest Clip**

Insert right half of chest clip into left half and snap together.

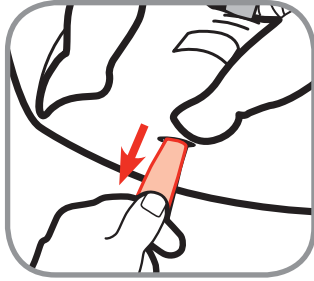

4. *Tighten Harness*

Pull on harness tightening strap to tighten harness snugly.

NOTE: A snug harness should not allow any slack. It lies in a relatively straight line without sagging. It does not press on the child's flesh or push the child's body into an unnatural position.

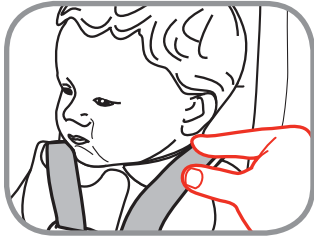

5. *Check Harness Tightness*

Try to pinch the harness at the shoulders.

If you can pinch the harness strap, tighten more.

If your fingers slip off, the harness is tight enough.



6. *Position Chest Clip*

The chest clip must be placed at mid-chest (even with armpits) and away from the child's neck.

⚠ WARNING:
Failure to fasten and tighten the harness system correctly and snugly can result in serious injury or death.

C-4 Removing Child From Child Restraint

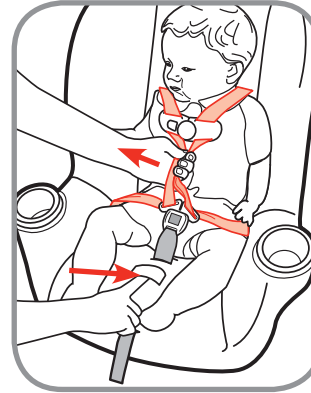

1. *Loosen Harness*

Push down on the harness release lever (under flap on the front of restraint) while pulling out on the harness.

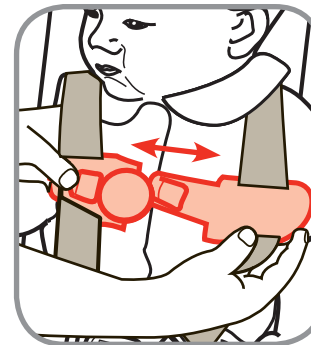

2. *Release Chest Clip*

Press on release button and pull apart.

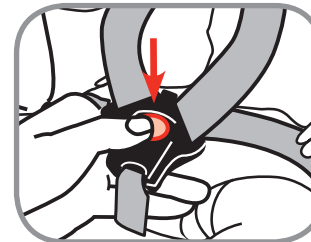

3. *Unbuckle Harness*

Press red button on buckle to release the buckle tongues. Move harness away from child and remove child.

C-5 Removing Pad for Cleaning

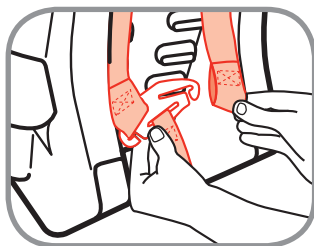

1. Remove Harness Straps from Splitter Plate

Fully loosen harness straps. Locate splitter plate on the back of the seat and unfasten the harness straps.

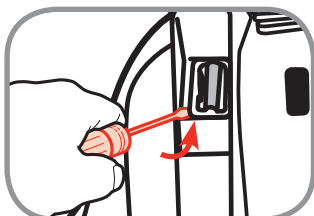

2. Remove Harness's Metal Retainer From Shell

Turn the child restraint over. Use a flathead screwdriver and lift metal retainer off plastic tab. Insert metal retainer through shell and pad. Repeat for other side.

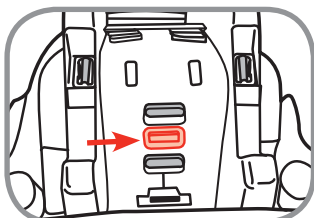
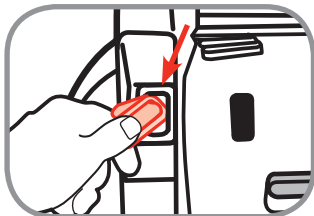

3. Locate Buckle's Metal Retainer



4. Insert Metal Retainer Through Shell and Pad

Rotate metal retainer, then insert retainer up through the shell and pad.

21

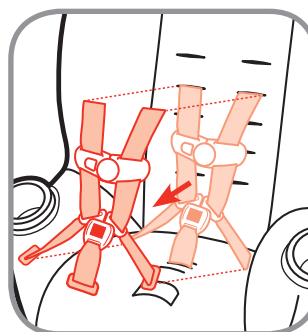

5. Pull Harness System Completely Out of the Shell and Pad

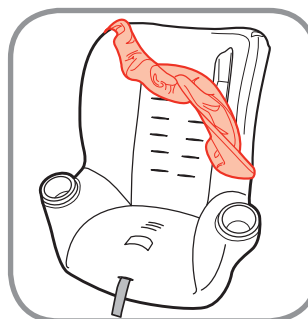

6. Remove Pad

Pull pad off the top of child restraint and remove pad.

Cleaning Seat Pad

Hand wash pad with warm sudsy water, rinse clean and air dry. Spot clean the harness straps. Do not use bleach or other harsh cleaners. Do not dry clean.

⚠ WARNING:

Do not use child restraint without the seat pad. Failure to do this can result in serious injury or death.

Replace child restraint pad by reversing order; Starting from bottom of child restraint, slip pad on shell; pull harness tightening strap through pad. Wrap pad around the top of shell. Pull pad around each cup holder and slip pad over the sides of the restraint.

Install harness system (see section C-6).

22

C-6 Installing Harness System

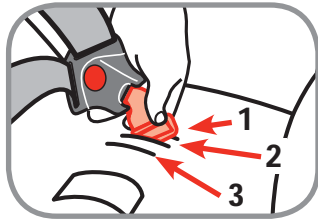

1. Install Buckle

Insert the buckle's metal retainer through the desired slot. Make sure that the buckle is facing out.

You MUST use the 1st or 2nd buckle strap slots when rear facing. Any slot can be used for forward facing.

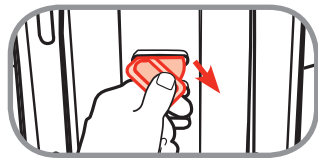

a. Pull buckle's metal retainer completely through pad and shell.

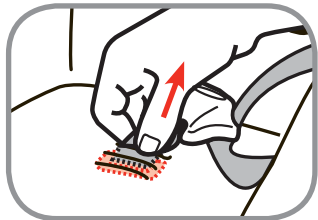

b. Check Buckle

Pull up on buckle to make sure it is secured.

The buckle must not pull out.

⚠ WARNING:

Failure to place buckle's metal retainer completely through pad and shell can result in serious injury or death.

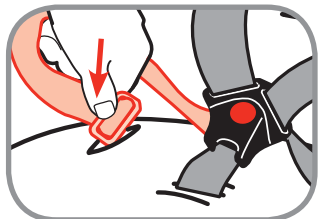

2. Thread Harness's Metal Retainer Into Shell

Push the harness's metal retaining into the lower harness slot making sure it goes completely through the pad and shell.

23

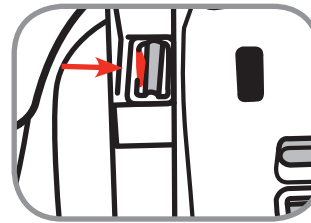

3. Lock Harness's Metal Retainer

Rotate the shell over to expose the bottom of shell. Pull on the harness straps to lock the metal retainer into place.

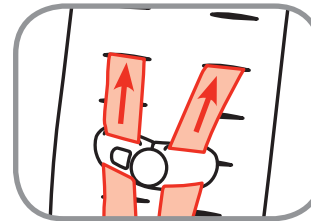

4. Thread Harness Strap

Push harness strap ends through upper harness slots at the same height.

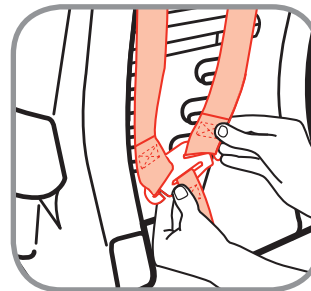

5. Attach Harness Strap to Splitter Plate

From the bottom of the child restraint, fit the harness strap loops onto the splitter plate.

The sewn end of the harness strap loops MUST face towards you. DO NOT twist harness straps or harness tightening strap and make sure the harness straps are COMPLETELY ON the splitter plate.

⚠ WARNING:

Harness system must be reattached correctly. Failure to follow these warnings can result in serious injury or death.

24

C-7 Accessories on Select Models

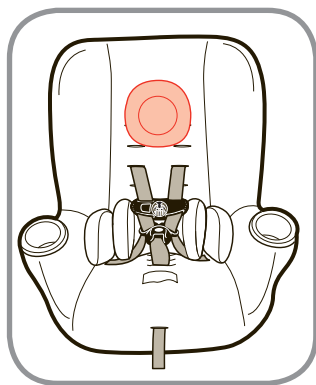

Head Pillow

To remove head pillow, from the back of the head pillow gently pull the fabric tabs out from the upper harness slots.

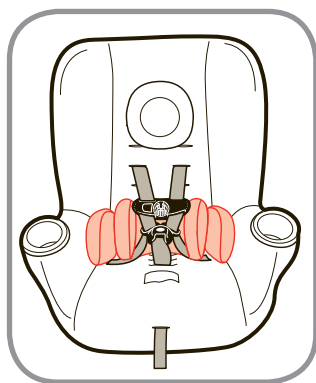

Body Pillow

To remove body pillow, slide out from behind the harness straps.

D-1 Understanding Your Vehicle

Your vehicle's features may be considerably different than those pictured here. Consult your vehicle owner's manual to help identify your vehicle's specific features and locations.

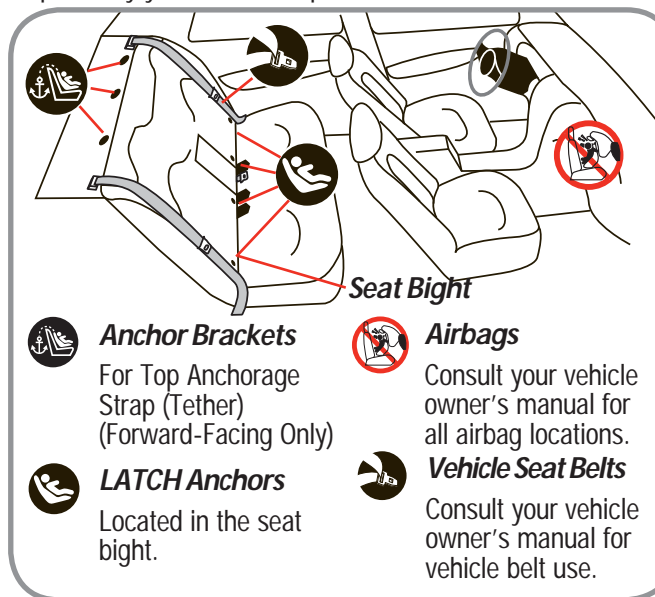

Safety Tip:

To avoid your child being seriously burned, take the following precautions:

1. Park in the shade or where sun does not directly hit the child restraint.
2. Cover the child restraint with a sheet or blanket when not in use.
3. Check for hot seat and buckles before placing child in child restraint.

To help protect your vehicle seat's upholstery from damage, use a single layered towel underneath and behind child restraint.

D-2 Vehicle Seating Position

Some seating positions in your vehicle may not be safe for this child restraint. Some vehicles do not have a seating position that can be used safely with this child restraint. If you are not sure where to place the child restraint in your vehicle, consult your vehicle owner's manual or contact Dorel Juvenile Group Consumer Relations Dept.

⚠ WARNING:



Never place a child rear facing in a seating position with an active frontal airbag. This can result in serious injury or death.

⚠ WARNING:



Use the child restraint only on vehicle seats that face forward. Do not use on seats that face the sides or rear of the vehicle.



Safety Tip:



Children are safer when properly restrained in rear seating positions than in the front seating positions.

According to National Highway Traffic Safety Administration information, children in rear seating positions are statistically safer, whether you have airbags, advanced airbags, or no airbags at all.

D-3 Choosing LATCH or Vehicle Belts

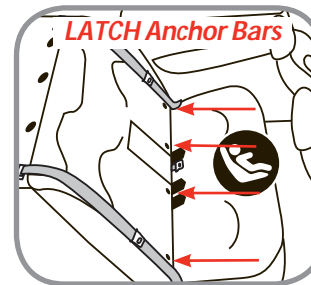

The LATCH System

LATCH (Lower Anchors and Tethers for Children) is a universal system for installing child restraints without using vehicle seat belts.

The LATCH system can ONLY be used in vehicles that have the LATCH anchor bars installed and designated LATCH seating positions. Most vehicles manufactured after September 2002 are equipped with LATCH.

Check your vehicle owner's manual to see which seating positions may be equipped with the LATCH system.

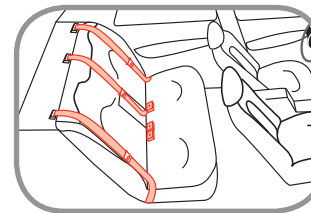

Vehicle Belts

If LATCH is not an option, you must use the vehicle seat belt system to install the child restraint. There are some vehicle belts that will not work with a child

restraint or will require special attention.

See next page and check your vehicle owner's manual for specific instructions.

⚠ WARNING:

Do not use both the LATCH belt and vehicle belt at the same time.

D-4 Knowing Your Vehicle Belts

Review your vehicle owner's manual for vehicle seat belt use with child restraints. This is your best source for information concerning your vehicle.

Not all vehicle belts will work with this child restraint. This child restraint must be tightly locked in place at all times, during travel. You must determine if your vehicles belts are compatible with this child restraint.

Vehicle Belts

• Automatic/Passive vehicle seat belts

You **MUST** have a vehicle lap belt to install any child restraint. An automatic (passive) shoulder vehicle belt may or may not have a separate vehicle lap belt. Consult your vehicle owner's manual.



• Vehicle belts in center of the door or side panel

You must move the child restraint to another seating location. Consult your vehicle owner's manual.

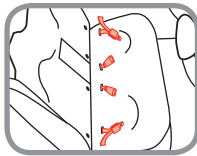

• Vehicle belts that are in front of the seat bight

You may need to move the child restraint to another seating location. Consult your vehicle owner's manual.

• Do Not Use with inflatable seat belts

You may need to move the child restraint to another seating location or use LATCH belts only.

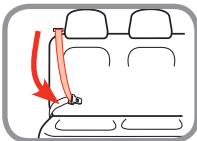

• ELR (Emergency Locking Retractor) vehicle belts

These lap and shoulder vehicle belts only lock in a sudden stop or crash, and do not properly secure a child restraint alone.

Consult your vehicle owner's manual.

To learn if you have this type of vehicle belt, gently pull the vehicle belt all the way out of the retractor (spool), let it return several inches, then pull on it again. If it moves freely, it is an ELR vehicle belt. If it is locked and will not allow any more vehicle belt to come out, it is a switchable retractor.

⚠ WARNING:
ELR lap-only vehicle belts **MUST NOT** be used with this child restraint.

• Switchable retractor

These vehicle belts switch from ELR to ALR (Automatic Locking Retractor). You must have the vehicle belts in the locking mode to use them. Follow the instructions in the installation sections.

• ALR (Automatic Locking Retractor)

These vehicle belts lock after pulling the webbing out and letting the vehicle belt go back into the retractor an inch or two. Follow the instructions in the installation sections.

Vehicle Latch Plates

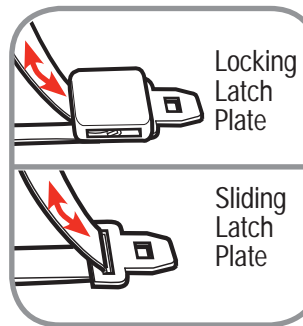

• Check the Latch Plates

Grasp the tongue portion of the latch plate (the part that goes inside the buckle) and pull straight out, in line with the vehicle lap belt. If the latch plate does not slide up and down the vehicle belt, you have a locking latch plate. You should not need to use a locking clip. Consult your vehicle owner's manual.

If the latch plate slides up and down on the vehicle belt, and you have an ELR retractor, you **MUST** use a locking clip to install the child restraint. You may not need to use the locking clip with a switchable or ALR retractor. Consult your vehicle owner's manual.

D-5 Aircraft Information



This restraint is certified for aircraft use.

Use only on forward-facing aircraft seats. Follow instructions for vehicle installation.

Contact the airline for their specific policies.

E-1 Preparing to Install Rear Facing

5-40 lbs (2.3-18 kg) and 19-40 in. (48-101.6 cm)
Rear Facing using 5-point harness



LATCH Belt



Lap/Shoulder Belt



Lap Belt

⚠ WARNING:



Never place a child rear facing in a seating position with an active frontal airbag. This can result in serious injury or death.

This child restraint must always face the rear of the vehicle and be reclined according to your child's weight when the child is less than 1 year old.



E-2 Preparing to Install LATCH Rear Facing

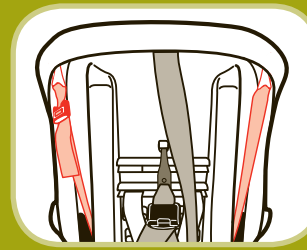

1. Unhook LATCH from Side of Shell

Remove the LATCH from the forward-facing belt path.



2. Routing LATCH Belt

Insert the LATCH hook **with** adjuster through the rear-facing belt path.



3. Pull Hook Across to Opposite Side

Reach under pad and pull the LATCH hook across the shell. LATCH belt **MUST** be under pad and in front of buckle strap.

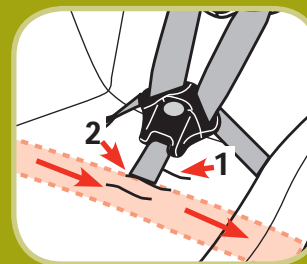

NOTE: You **MUST** use the 1st or 2nd buckle strap slots when rear facing.

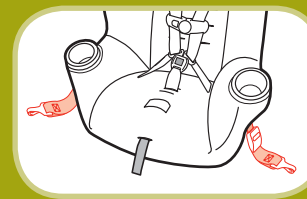

4. Finished LATCH Routing

Make sure the LATCH belt is not twisted.



E-3 Installing Rear Facing with LATCH

NOTE: Review your vehicle owner's manual for LATCH belt use.

⚠ WARNING:

Do not use the LATCH along with the vehicle lap or lap/shoulder belt.

Check LATCH belt before each use. Use only if the belt can be tightened properly and securely.

Attach the tether hook the storage location on back of child restraint when used rear facing.

Failure to follow these warnings can result in serious injury or death.

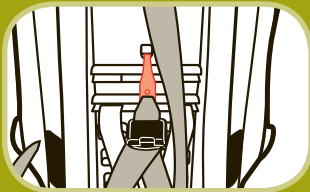

1. Store Tether



2. Place Child Restraint in the Back Seat Rear Facing

Move the front seats forward to give you room to install the child restraint.

For children between 5-22 lbs (2.3-10 kg), the bottom level-to-ground line **MUST be level with the ground. Rotate the child restraint to make the line level.**

33



For children 22-40 lbs (10.1-18 kg) and can sit up unassisted, rotate the child restraint between the 2 level-to-ground lines. Start by making the bottom level-to-ground line level, then rotate seat up. **DO NOT rotate past the top most upright level-to-ground line.**

Adjust child restraint if needed.

You may need to place a large rolled towel(s) or foam pool noodle(s) (A) under the front of the child restraint to help achieve the correct recline. Check often to be sure padding is still in place and the LATCH belt is tight.

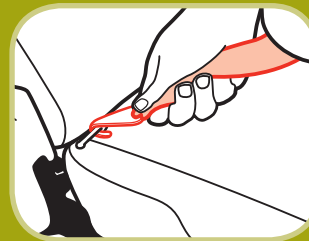

3. Hook LATCH to Vehicle Anchor

Fasten one LATCH belt hook to the anchor in the vehicle seat located in the vehicle seat bight.

Repeat for other side of child restraint.

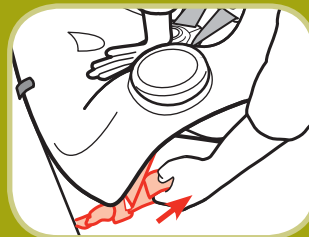

4. Tighten LATCH Belt

Push down firmly on the child restraint and pull up on the free end of LATCH belt to tighten.

34

continued on next page

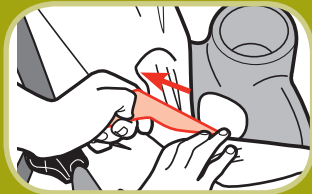

It may be easier to tighten the LATCH belt through the belt path opening as shown.

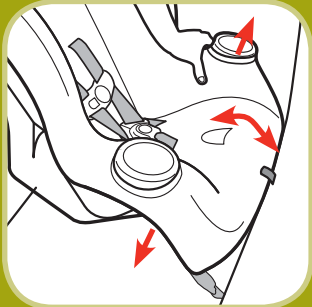

5. Check Belt Tightness

Grasp the child restraint at the belt path with one hand. Push and pull the child restraint from side to side, forward and back. The child restraint should not move more than 1 in (2.5 cm).

NOTE: If it moves more than 1 in (2.5 cm), try reinstalling the child restraint or try another seating location.

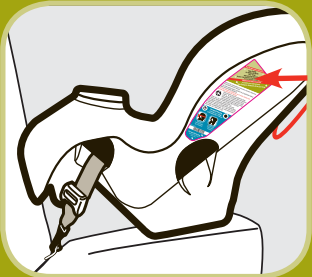

Secure your child in the child restraint.

Recheck the recline angle to make sure it is reclined according to your child's weight. Repeat steps if not reclined correctly.



To Remove LATCH Belt From Vehicle Anchor

Remove child from child restraint. Press down firmly on adjuster side of child restraint and press release button to release tension. Unhook LATCH from anchor bar by squeezing spring lever and twist hook.



E-4 Installing Rear Facing with Vehicle Belts

NOTE: Review section D-4 to determine what kind of vehicle belts you have. Review your vehicle owner's manual for vehicle seat belt use.

⚠ WARNING:

Do not use the LATCH along with the vehicle lap or lap/shoulder belt. Store LATCH belt when using the vehicle belts.

Check the vehicle belt before each use. Use only if the belt is tightened properly and securely.

Attach the tether hook to the storage location on back of child restraint when used rear facing.

Failure to follow these warnings can result in serious injury or death.

1. Store LATCH

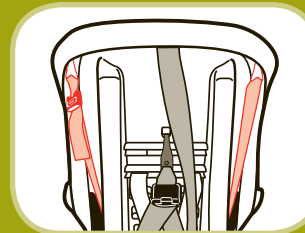

2. Store Tether

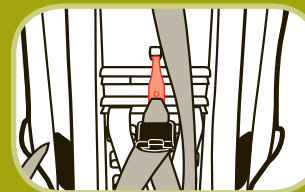



3. Place Child Restraint in the Back Seat Rear Facing

Move the front seats forward to give you room to install the child restraint.

For children between **5-22 lbs (2.3-10 kg)**, the bottom level-to-ground line **MUST** be level with the ground. Rotate the child restraint to make the line level.



For children **22-40 lbs (10.1-18 kg)** and can sit up unassisted, rotate the child restraint between the 2 level-to-ground lines. Start by making the bottom level-to-ground line level, then rotate seat up. **DO NOT** rotate past the top most upright level-to-ground line.

Adjust child restraint if needed.

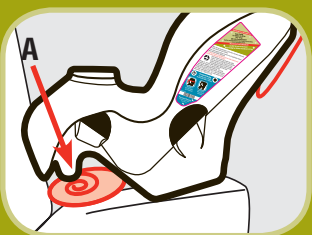

You may need to place a large rolled towel(s) or foam pool noodle(s) **(A)** under the front of the child restraint to help achieve the correct recline. Check often to be sure padding is still in place and the vehicle belt is tight.

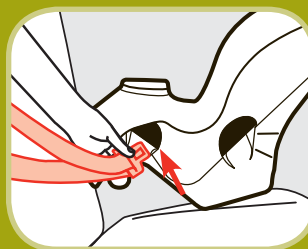

4. Thread Vehicle Belt

Thread the vehicle lap or lap/shoulder belt combination through the rear-facing belt path.

NOTE: With an ALR vehicle belt, pull the vehicle belt all the way out before threading the child restraint.

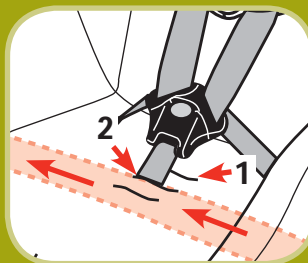

5. Pull Latch Plate Across to Opposite Side

Reach under pad and pull the vehicle belt across the shell.

Vehicle belt **MUST** be under pad and in front of buckle strap. **Do not place vehicle belt over child's legs.**

Buckle vehicle belt.

NOTE: You **MUST** use the 1st or 2nd buckle strap slots when rear facing.

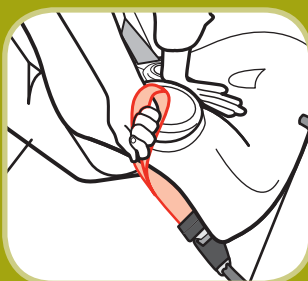

6. Tighten Vehicle Belt

Push down firmly on the child restraint and pull on the vehicle shoulder belt to tighten.

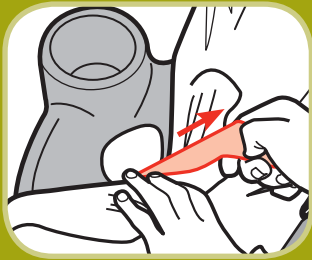

It may be easier to tighten the vehicle belt through the belt path opening as shown.

NOTE: With a switchable retractor, pull the vehicle shoulder belt all the way out to switch the retractor into the ALR mode before tightening. Feed the slack back into the retractor while tightening.

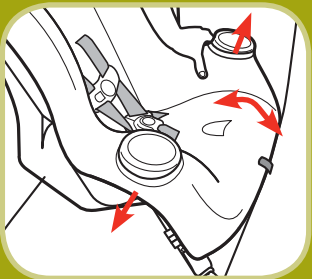

7. Check Belt Tightness

Grasp the child restraint **at the belt path** with one hand. Push and pull the child restraint from side to side, forward and back. The child restraint should not move more than 1 in (2.5 cm).

NOTE: If it moves more than 1 in (2.5 cm), try reinstalling the child restraint or try another seating location.

Secure your child in the child restraint.



Recheck the recline angle to make sure it is reclined according to your child's weight. Repeat steps if not reclined correctly.

F-1 Preparing to Install Forward Facing

22-40 lbs (10.1-18 kg) and 34-43 in. (85.1-110 cm) and at least 1 year old. Forward Facing using 5-point harness

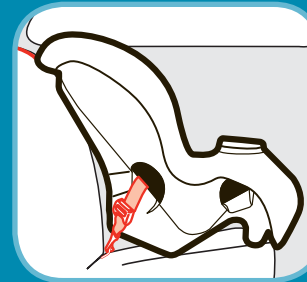

LATCH Belt with tether

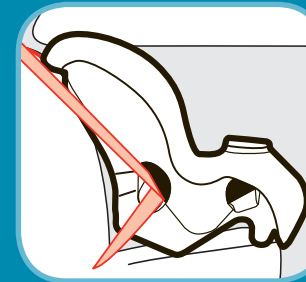

Lap/Shoulder Belt with tether

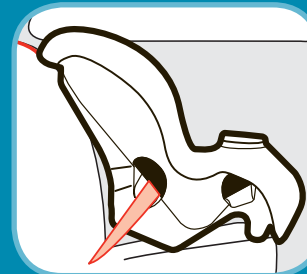

Lap Belt with tether

⚠ WARNING:

Never place a child less than 1 year old or weighing less than 22 lbs. (10.1 kg) forward facing.

Safety Tip:

Experts agree that children should remain rear facing as long as possible. In this child restraint, your child can remain rear facing up to 40 lbs (18 kg) and up to 40 inches (101.6 cm).



F-2 Adjusting Top Anchorage Strap (Tether)

The tether is used for the forward-facing position only.

NOTE: We strongly recommend that you use the tether in the forward-facing position. If your vehicle does not have an anchor bracket, please see your dealer or a qualified mechanic and have one installed. The tether can greatly improve the performance of this child restraint.

Storage of Top Anchorage Strap (Tether):

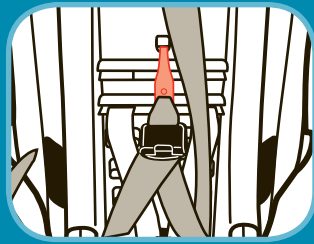

When the tether is not in use, attach the tether hook to the storage location on back of child restraint as shown. Gently tighten tether to remove the slack.

To Adjust Top Anchorage Strap (tether):



Pull loose end to tighten

To tighten; After the child restraint is locked into place with LATCH or vehicle belt, push down on child restraint and pull on free end of tether.

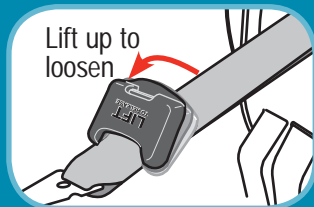

Lift up to loosen

To loosen; Lift up on top anchorage lock and push lock adjuster toward tether hook.



F-3 Preparing to Install LATCH Forward Facing



NOTE: Pull the LATCH belt out of the rear-facing belt path if you have used this child restraint rear facing.

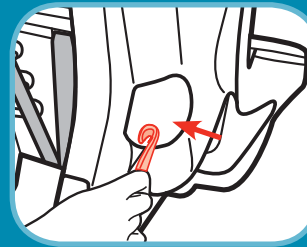

1. Routing LATCH Belt

Insert the LATCH hook with the adjuster closest to it, through the forward-facing belt path.

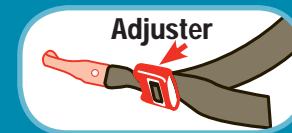

Adjuster

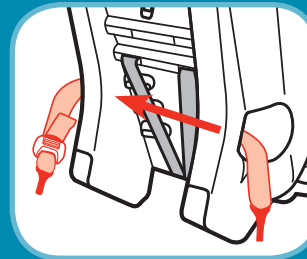

2. Thread LATCH Across

Pull the LATCH hook across the back and out the other side as shown.

Make sure the belt is not twisted.



F-4 Installing Forward Facing with LATCH



NOTE: Review your vehicle owner's manual for LATCH belt use.

⚠ WARNING:

Do not use the LATCH along with the vehicle lap or lap/shoulder belt.

Check LATCH belt before each use. Use only if the belt can be tightened properly and securely.

Failure to follow these warnings can result in serious injury or death.



1. *Place Child Restraint Flush Against Vehicle Seat Back Forward Facing*

Installation Tip:

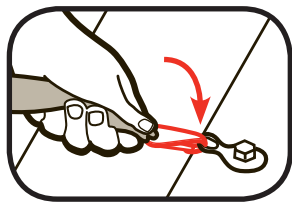

Loosely attach the tether hook before connecting the LATCH belt. Consult vehicle owner's manual for specific location.

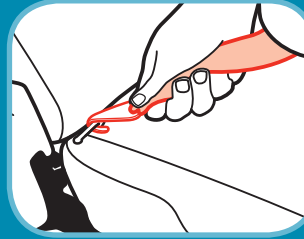

2. *Hook LATCH to Vehicle Anchor*

Fasten one LATCH belt hook to the anchor in the vehicle seat located in the vehicle seat bight. Repeat for other side of child restraint.

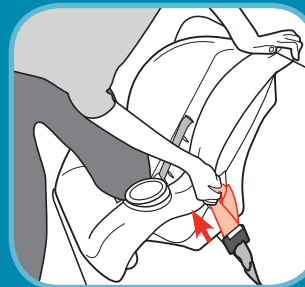

3. *Tighten LATCH Belt*

Push down firmly while pulling up on the free end of the LATCH belt to tighten.

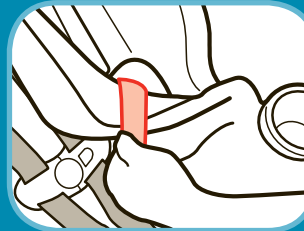

It may be easier to tighten the LATCH belt through the belt path opening as shown.

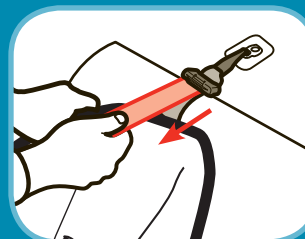

4. *Tighten Tether*

Push firmly on the back of the child restraint and tighten tether.

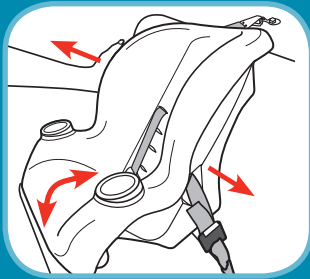

5. Check Belt Tightness

Grasp the child restraint at the belt path with one hand. Push and pull the child restraint from side to side, forward and back. The child restraint should not move more than 1 in. (2.5 cm).

NOTE: If it moves more than 1 in. (2.5 cm) try reinstalling the child restraint or try another seating location.

Secure your child in the child restraint.



To Remove LATCH Belt From Vehicle Anchor

Remove child from child restraint. Press down firmly on adjuster side of child restraint and press release button to release tension. Unhook LATCH from bar by squeezing spring lever and twist hook.



F-5 Installing Forward Facing With Vehicle Belts



NOTE: Review section D-4 to determine what kind of vehicle belts you have. Review your vehicle owner's manual for vehicle seat belt use.

⚠ WARNING:

Do not use the LATCH along with the vehicle lap or lap/shoulder belt. Store LATCH belt when using the vehicle belts.

Check the vehicle belt before each use. Use only if the belt is tightened properly and securely.

Failure to follow these warnings can result in serious injury or death.

1. Store LATCH

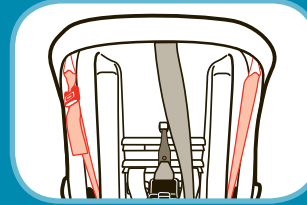

2. Place Child Restraint Flush Against Vehicle Seat Back Forward Facing



Installation Tip:

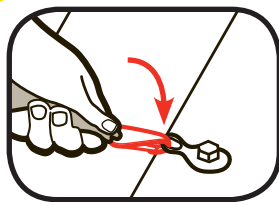

Loosely attach the tether hook before threading the vehicle belt. Consult vehicle's owner manual for specific location.

3. Thread Vehicle Belt

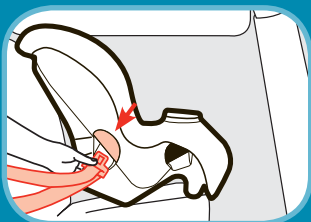

Thread the vehicle lap or lap/shoulder belt combination through the forward-facing belt path and out the other side. Buckle vehicle belt.

4. Tighten Vehicle Belt

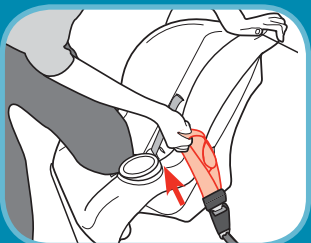

Push down firmly on the child restraint and pull on the vehicle shoulder belt or lap belt adjuster to tighten.

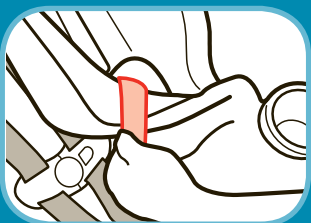

It may be easier to tighten the vehicle belt through the belt path opening as shown.

NOTE: With a switchable retractor, pull the vehicle shoulder belt all the way out to switch the retractor into the ALR mode before tightening. Feed the slack back into the retractor while tightening.

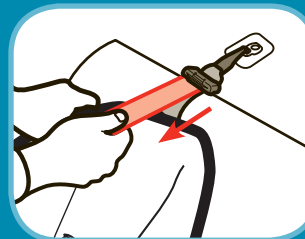

5. Tighten Tether

Push firmly on the back of the seat and tighten tether.

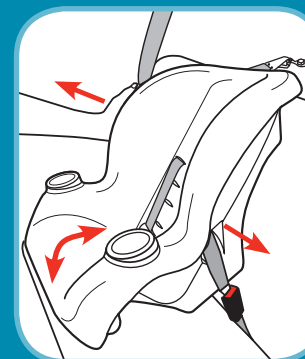

6. Check Belt Tightness

Grasp the child restraint **at the belt path** with one hand. Push and pull the child restraint from side to side, forward and back. The child restraint should not move more than 1 in. (2.5 cm).

NOTE: If it moves more than 1 in. (2.5 cm) try reinstalling the child restraint or try another seating location.

Secure your child in the child restraint.

Using a Locking Clip

You will rarely need to use a locking clip except in some older vehicles. Built in child restraint locking systems have been required in vehicles since 1996, and many vehicles had these features even earlier.

Check your vehicle owner's manual to learn how to use the systems in your vehicle. If you need a locking clip, return to the store where you purchased this child restraint to purchase a locking clip or call us at 1-800-544-1108 to order one.

Locking clips from any child restraint manufacturer are okay to use.

Remove the locking clip when the vehicle seat belt is not being used with the child restraint. **A locking clip will not fix all types of seat belt problems.**

Refer to section D-4 to determine if your vehicle belts require a locking clip.

The following directions describe installing the child restraint rear-facing. Same steps apply for forward facing, except install the restraint forward facing and thread the vehicle belt in the forward-facing belt path.

⚠ WARNING:

Do not use both the LATCH belt and vehicle belt at the same time.

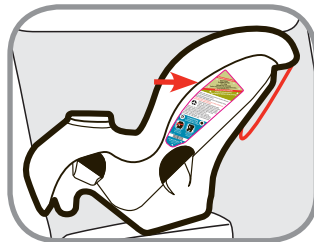

1. Place Child Restraint in the Back Seat Rear Facing

Move the front seats forward to give you room to install the child restraint.

NOTE: Attach the top anchorage hook (tether) to

the storage location on back of child restraint. See section F-2.



For children between 5-22 lbs (2.3-10 kg), the bottom level-to-ground line **MUST** be level with the ground. Rotate the child restraint to make the line level.

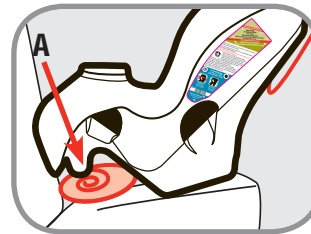

For children 22-40 lbs (10.1-18 kg) and can sit up unassisted, rotate the child restraint between the 2 level-to-ground lines. Start by making the bottom level-to-ground-line level, then rotate seat up. **DO NOT** rotate past the top most upright level-to-ground line. Adjust child restraint if needed.

You may need to place a large rolled towel(s) or foam pool noodle(s) **(A)** under the front of the child restraint to help achieve the correct recline. Check often to be sure padding is still in place and the belt is tight.

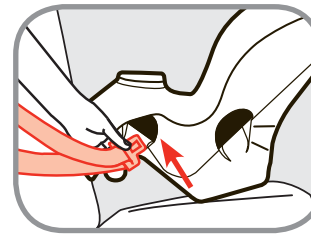

2. Thread Vehicle Belt

Thread the vehicle lap/shoulder belt combination through the rear-facing belt path.

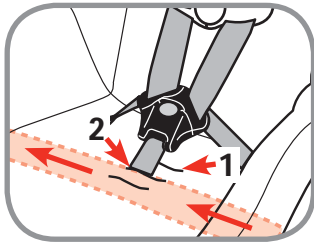

3. Pull Latch Plate Across to Opposite Side

Reach under pad and pull the vehicle belt across the shell.

Vehicle belt **MUST** be under pad and in front of buckle strap. **Do not place**

vehicle belt over child's legs. Buckle vehicle belt.

NOTE: You **MUST** use the 1st or 2nd buckle strap slots when rear facing.

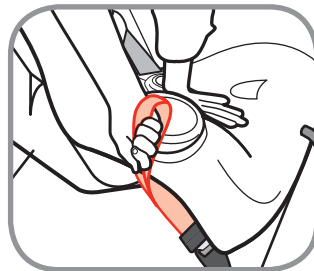

4. Tighten Vehicle Belt

Push down firmly on the child restraint and while pulling on the vehicle shoulder belt to tighten.

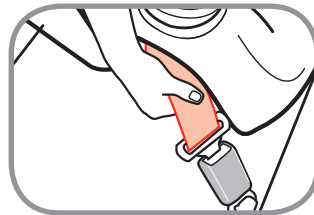

5. Locate Locking Clip Location

Grasp both vehicle belts together just behind the latch plate and unbuckle.

NOTE: If the latch plate ends up just at the belt

path opening so you cannot grasp the vehicle belt at the latch plate, grasp the vehicle belts on the opposite side of the child restraint, as close to the latch plate as possible.

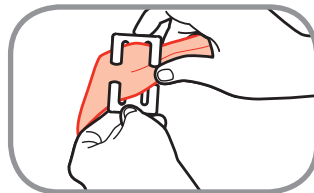

6. Attach Locking Clip

Thread both portions of the vehicle belt onto the locking clip, as close to the latch plate as possible.

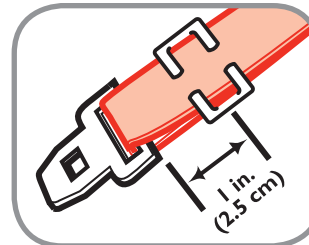

7. Position Locking Clip

Position locking clip about 1 in. (2.5 cm) from vehicle belt's latch plate.



8. Rebuckle Vehicle Belt

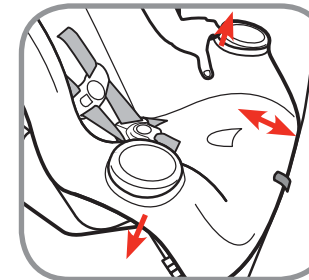

9. Check Vehicle Belt Tightness

Grasp the child restraint at the belt path with one hand. Push and pull the child restraint from side to side, forward and back. The child restraint should not move more than 1 in. (2.5 cm).

NOTE: If it moves more than 1 in. (2.5 cm), redo steps 2 through 9 again or try another seating location.

Secure your child in the child restraint.

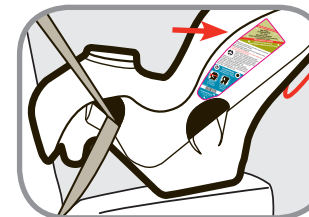

Recheck the recline angle to make sure it is reclined according to your child's weight.

Repeat steps if not reclined correctly.

Remove the locking clip when the vehicle seat belt is not being used with a child restraint.

Troubleshooting

- 1. If the child restraint buckle or harness release lever sticks or you cannot get the straps tight enough around child:** DO NOT LUBRICATE. Check around lever and retractor for dropped food, sticky spilled drinks, dirt, leaves, etc. Clean with warm water and/or remove object with tweezers. If you cannot get the harness to adjust and remain tight with the buckle securely locked, do not use the child restraint.
- 2. If your harness twists:** Straighten the harness each time you put your child in the child restraint to help prevent twisting. Lock the buckle and tighten harness and it will be ready for next use.
- 3. Locate a Child Safety Seat Inspection Station for hands on training on how to use your child restraint:** Visit your local Child Passenger Inspection Station or go to <http://www.nhtsa.dot.gov/cps/cpsfitting/index.cfm> to find your closest station.

Warranty

Dorel Juvenile Group, Inc. (DJG) warrants this product to the original retail purchaser as follows:
This product is warranted against defective materials or workmanship for one year from the date of original purchase. **An original receipt is required to validate your warranty.** DJG will, at its option, provide replacement parts or replace this product. DJG reserves the right to substitute if the part or model has been discontinued.
To make a claim under this warranty you may contact us at www.djgusa.com, fax us at 1-800-207-8182 24 hours a day, write to DJG, Consumer Relations Department, P. O. Box 2609, Columbus, IN 47202-2609, or call 1-800-544-1108 from 8:00 a.m. to 6:00 p.m. EST Monday through Thursday and from 8:00 a.m. to 4:30 p.m. on Friday. **Proof of purchase is required and shipping charges are the responsibility of the consumer.**

Warranty Limitations:

This warranty does not include damages which arise from misuse or abuse of this product.

Limitation of Damages:

The warranty and remedies as set forth are exclusive and in lieu of all others, oral or written, expressed or implied. In no event will DJG or the dealer selling this product be liable to you for any damages, including incidental or consequential damages, arising out of the use or inability to use this product.

Limitation of warranties and other warranty terms and state law rights:

Any implied warranties, including implied warranties of the merchantability and fitness for a particular purpose, shall be limited to the duration and terms of the express written warranty. Some states do not allow limitations as to how long an implied warranty lasts or the exclusion or limitation of incidental or consequential damages, so the above limitations may not apply to you. This warranty gives you specific legal rights, and you may have other rights, which vary from state to state. Neither DJG nor the dealer selling this product authorized any person to create for it any other warranty, obligation, or liability in connection with this product.

Replacement Parts Order Form

Complete the form below. Your model number with color code and manufacture date code **MUST** be included on the form to ensure proper replacement parts. Your model number with color code and the manufacture date code can be found on a sticker on the side of child restraint. Payment in U.S. dollars must accompany your order. Choose parts needed from the list on the next page.

Return the form with payment to:

Dorel Juvenile Group, Inc.
Consumer Relations Department
P.O. Box 2609
Columbus, IN 47202-2609

Fax orders to: 1-800-207-8182

Please make money orders payable to Dorel Juvenile Group, Inc. Fill in the area below to charge to Visa or Mastercard. We do not accept personal checks, cash, or Discover Card. All outside of U.S. and Canada **MUST** use credit card.

Ship To (Please Print): _____

Name: _____

Address: _____

City: _____

State/Province: _____ Zip _____

Telephone: _____

Email Address: _____

We **MUST have this information
to process your order:**

Model Number (5 digits & 3 or 4 letters): _____

Manufacture Date (mm/dd/yyyy): _____

Replacement Parts List

NOTE: If requested color is not available, similar color will be substituted.

Part	Cost	Quantity	Total Cost
Buckle Strap/Buckle....	\$4.99	X _____	= \$ _____
Harness Strap	\$2.99	X _____	= \$ _____
Seat Pad	\$19.99	X _____	= \$ _____
Chest Clip.....	\$1.50	X _____	= \$ _____
Locking Clip	\$2.50	X _____	= \$ _____
Tether Kit	\$9.99	X _____	= \$ _____
Latch Kit.....	\$24.99	X _____	= \$ _____
Instructions	\$0.00	X _____	= \$ _____

Merchandise Total \$ _____

Shipping and handling: \$ _____

Up to \$25.00.....	\$5.95	\$100.01 to \$150.00	\$10.95
\$25.01 to \$50.00	\$6.95	\$150.01 to \$200.00	\$11.95
\$50.01 to \$75.00	\$8.95	\$200.01 and up	\$13.95
\$75.01 to \$100.00	\$9.95		

Outside Continental USA \$10.00

Sales Tax \$ _____
 (Indiana, California, and Massachusetts residents add applicable sales tax.)

Grand Total \$ _____

No shipping and handling on instructions for quantities under 6. Add \$.50 for each instruction over 6, then add applicable shipping and handling.

CUT ON DOTTED LINE

Fill Out For Credit Card

Visa Mastercard

Card Exp. Date: _____

Cardholder's Name: _____

Card Number: _____

Signature _____