

Side Chair

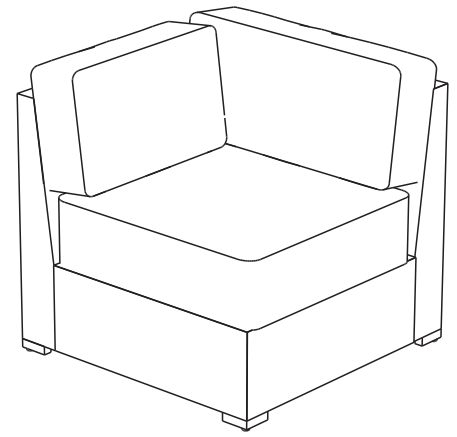

IMPORTANT

Carefully remove all the parts from the carton and place them individually on a soft cloth to prevent scratches or other damage.

Carefully and strictly follow these assembly instructions to ensure a completed product as designed.

Do not use power tools above 8 volts to assemble.

Part List

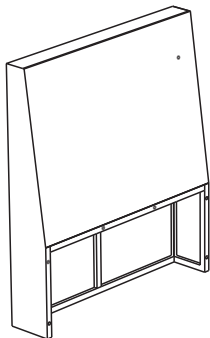

L.
Back
1 pc.

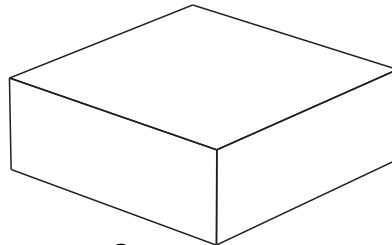

Q.
Seat
1 pc.

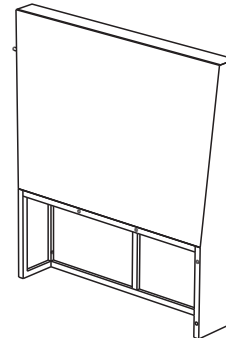

N.
Back
1 pc.



E.
Foot
4 pcs.

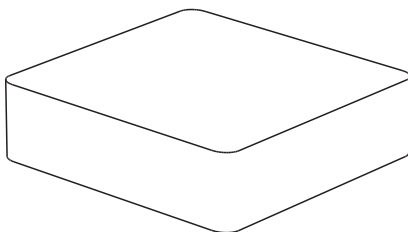

R.
Seat Cushion
1 pc.

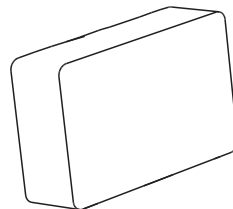

I.
Back Cushion
1 pc.

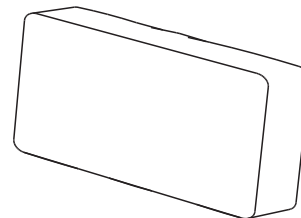

K.
Back Cushion
1 pc.



J.
Clip
2 pcs.

Hardware List

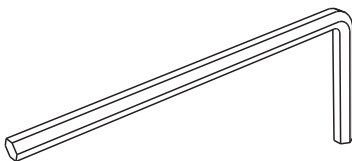

Hex Wrench
1 pc.



Small
Hex Wrench
1 pc.

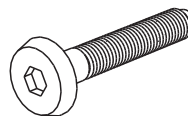

M6x35
Head Cap Bolt
18 pcs. (+1 extra)



Spring Washer
18 pcs. (+1 extra)



Flat Washer
18 pcs. (+1 extra)

Tool(s) required for assembly: Level

Assembly Instructions 2/6

IMPORTANT

- Use a soft cloth between these parts and the floor.
- Do not use power tools above 8 volts to assemble.
- Do not tighten all the bolts until each part is properly assembled.
- The unit must be level to work properly. Use the included adjustable levelers to level.
- Keep Hex Wrench as the bolts may need to be tightened in the future.

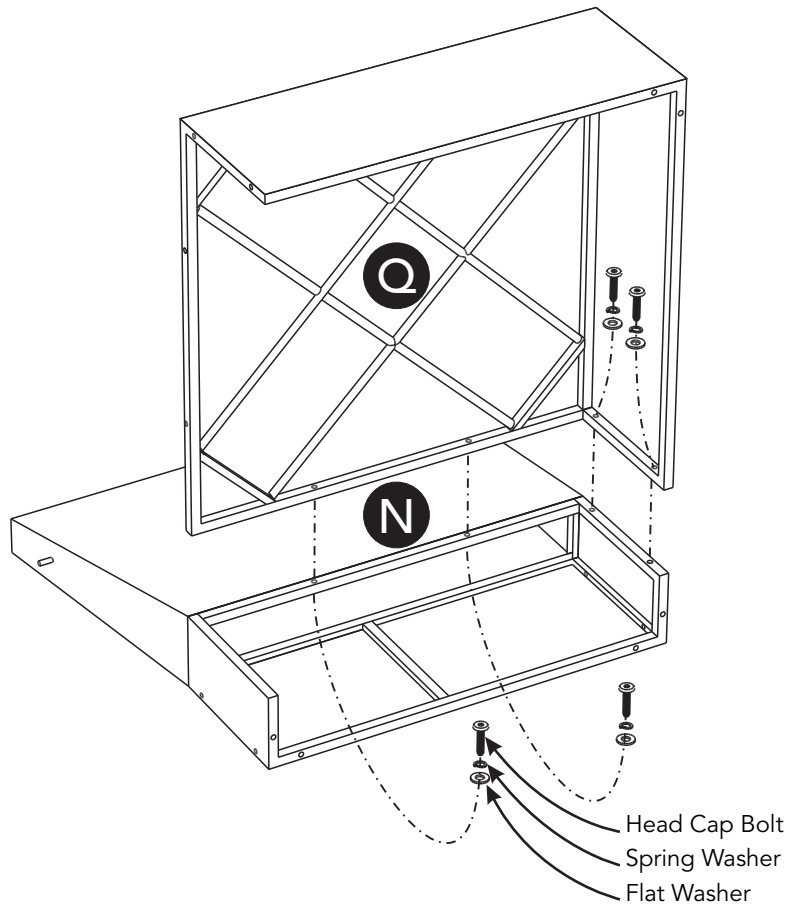

STEP 1

Attach Seat (Q) to Back (N) with Head Cap Bolts, Spring Washers and Flat Washers, tightening bolts only halfway.
(See Figure 1)

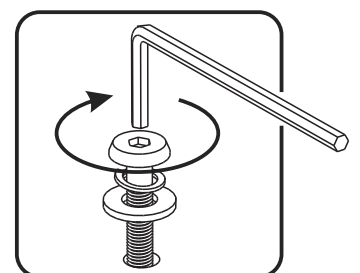
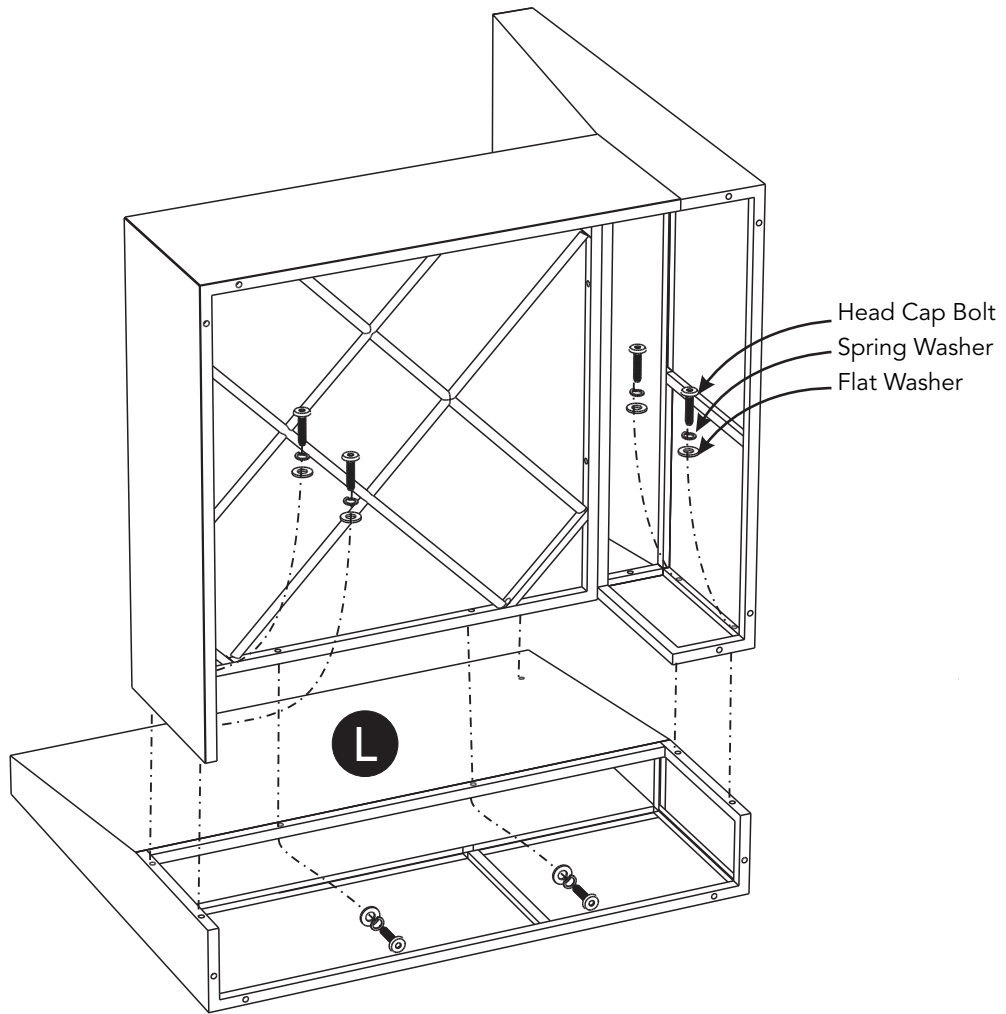

Figure 1

Assembly Instructions 3/6



STEP 2

Attach Back (L) to unit with Head Cap Bolts, Spring Washers and Flat Washers, tightening bolts only halfway.

Assembly Instructions 4/6

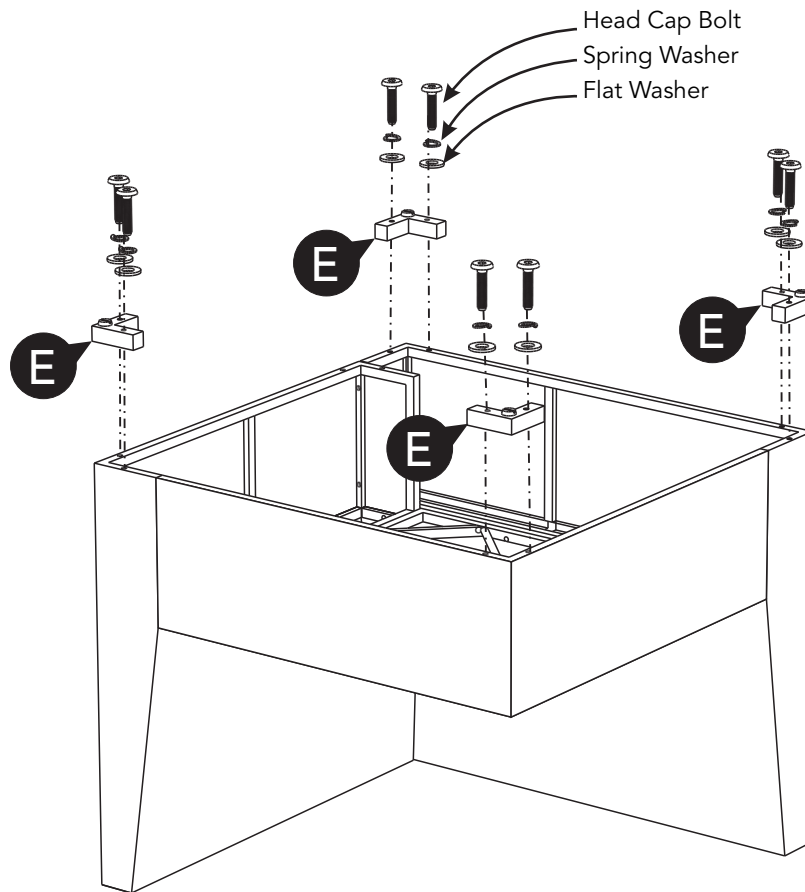

STEP 3

Attach Feet (E) to unit with Head Cap Bolts, Spring Washers and Flat Washers.

Assembly Instructions 5/6

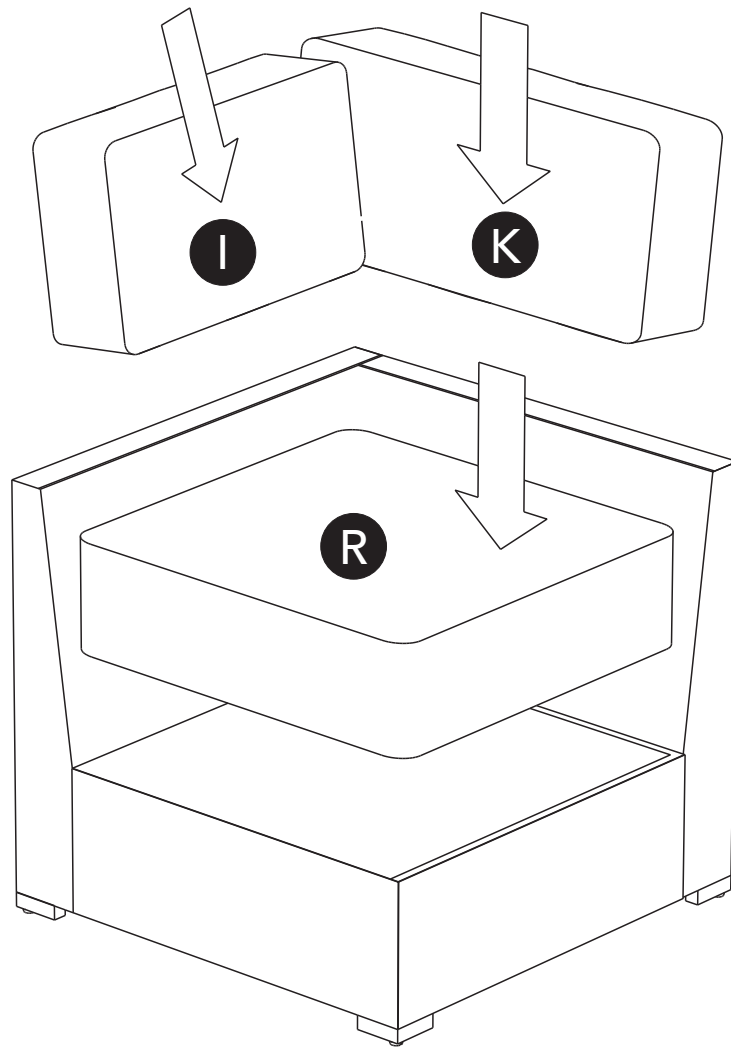

STEP 4

Turn unit to its upright position.

Attach Seat Cushion (R) to unit by pushing toggles through weaving in back of unit.
(See Figure 2)

Place Back Cushions (I) and (K) into position.

Level unit by adjusting the adjustable levelers on bottom of unit.
(See Figure 3)

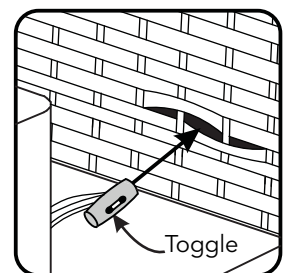

Figure 2

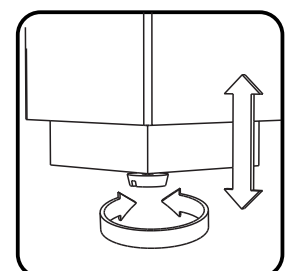

Figure 3

Assembly Instructions 6/6

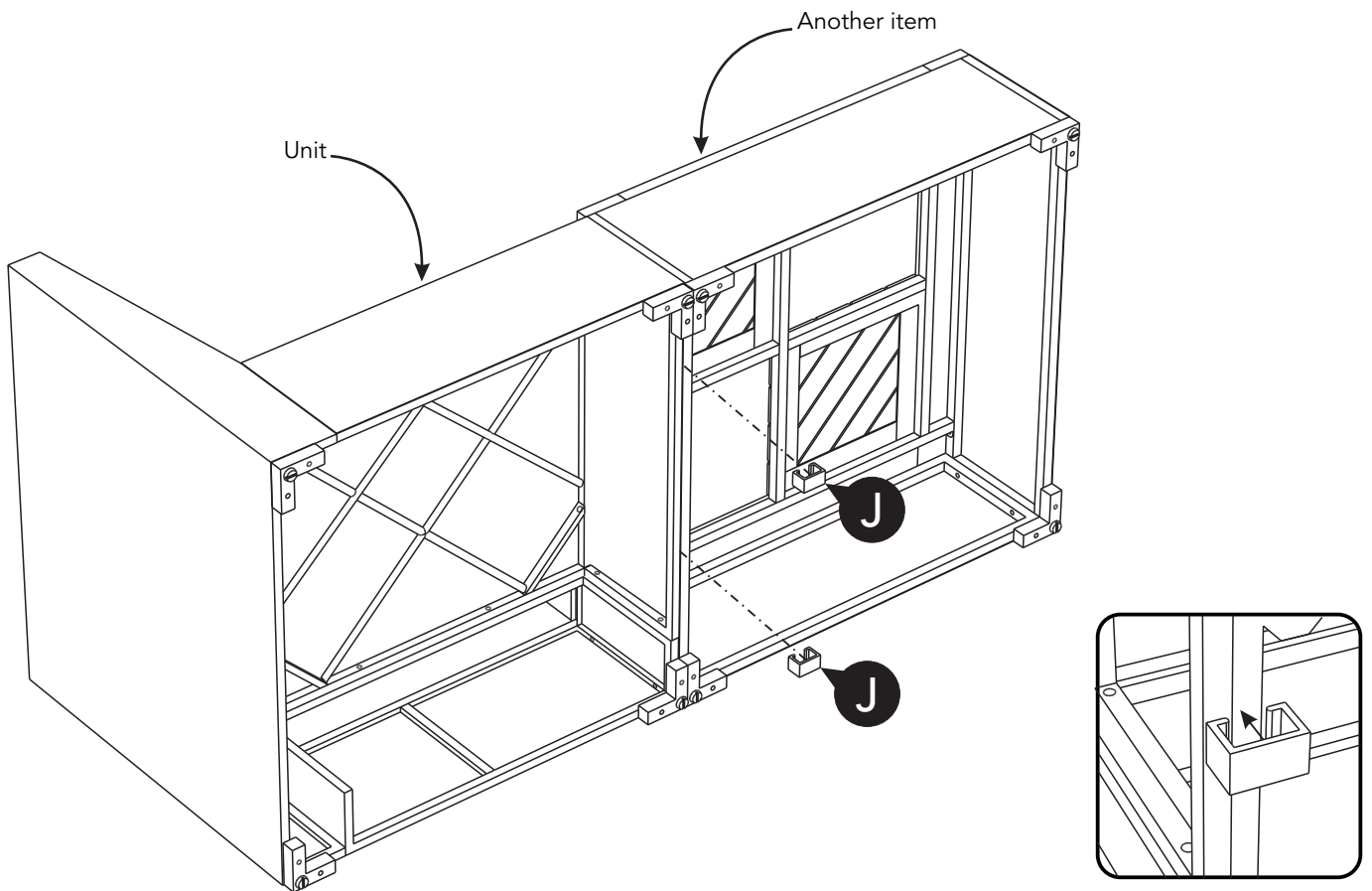
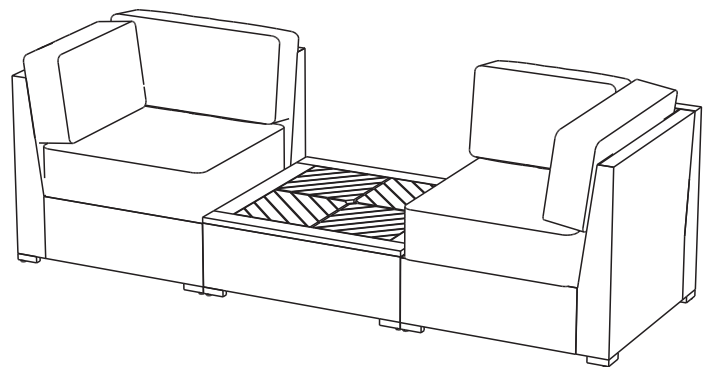
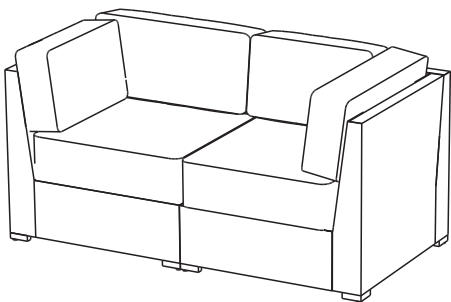

Figure 4

Note : Two Clips (J) are included in this carton. They may be used to attach this unit to another item in this collection if other items have been purchased. (See Figure 4)
Other items which may be attached to this unit include another 6800-12 Side Chair or a 6800-21 Coffee Table.



CARE INSTRUCTIONS

NEVER

allow liquids to remain on furniture.
Absorption causes parts to warp
and split and finishes to delaminate.

NEVER

use glass cleaners on
finished furniture. Ammonia
chemically attacks the finish.



Do not use power tools
above 8 volts to assemble.

**PREVENT
CRACKING**

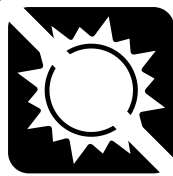

Do not place
in direct sunlight.

**PREVENT
FADING**



Do not write
directly on surface.

**PREVENT
MARKING**



Do not place hot
objects on surface.

**PREVENT
FINISH DAMAGE**

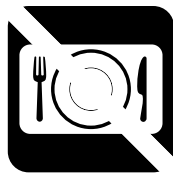

Do not use rubber
based placemats.

**PREVENT
DISCOLORING**



Do not use commercial
waxes and polishes.

**PREVENT
YELLOWING**

CLEAN

with a soft cloth moistened
in lukewarm soap and water.
Buff with a dry clean cloth.

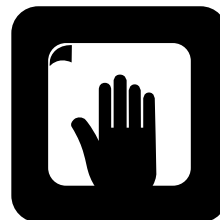

homestyles will provide replacements free of charge for missing or damaged parts within 1 year of purchase. Digital images of the defective parts may be required. If the product was not purchased from an authorized retailer, **homestyles** is under no obligation to provide replacement parts. Parts are not available for fully assembled items nor are parts available for sale. Replacements for missing or damaged parts may be requested via contact info below.

homestyles Customer Service: www.homestylesfurniture.com,
servicedesk@homestylesfurniture.com, 888-680-7460