

HAT TRICK 4' AIR HOCKEY TABLE - NG1015H

Spec Sheet

UPC Code: 672875902842

2-color graphic on white 1/8" MDF play surface with approx. 1,112 holes in 1" square grid pattern over 1/2" air plenum that is baffled to control air flow



Securely mounted 5 blade axial fan
AC120V 50/60 Hz 0.28A 24W 2P

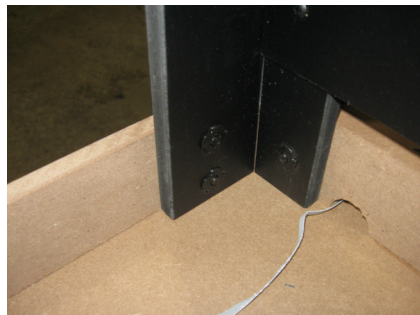

Leg attachment method

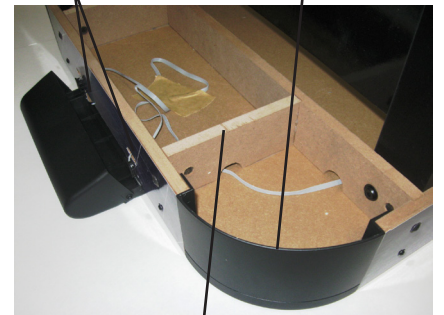







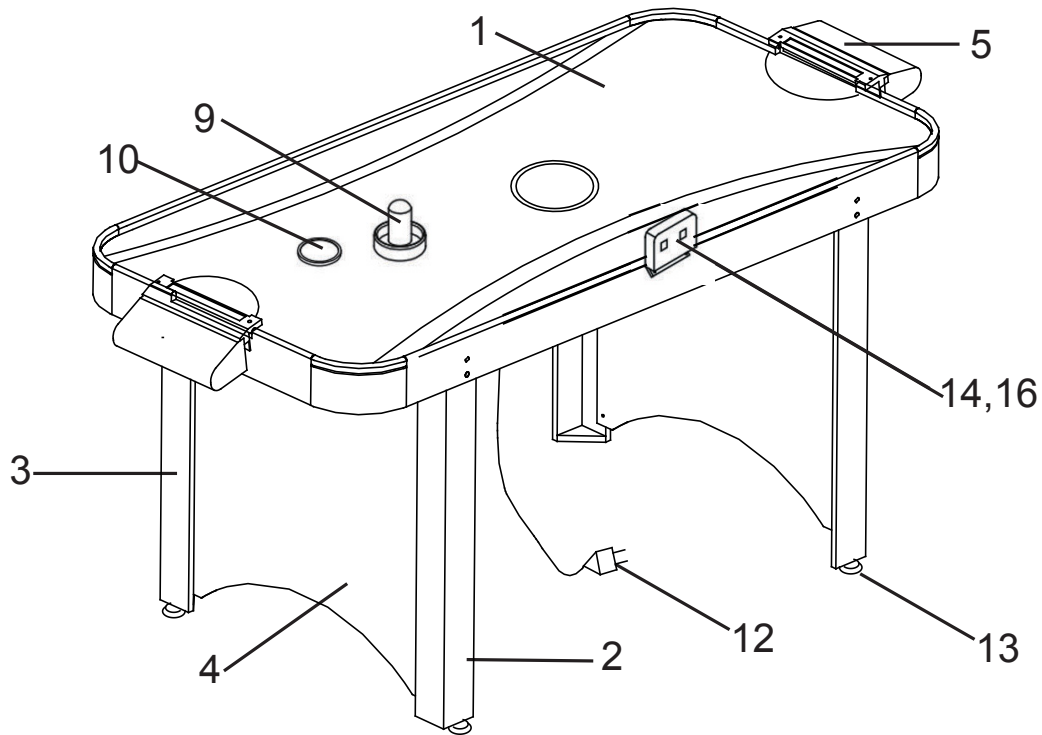

Bottom support structure 1/2" MDF

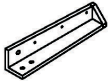
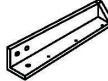
HAT TRICK 4' AIR HOCKEY TABLE - NG1015H

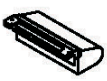



Spec Sheet



PARTS

#1 NGP50783 48" x 24" x 3.75" 1/2" MDF  TABLE BODY x1	#2 NGP5079 28.75" x 2.25" x 3" 1/2" MDF  RIGHT LEG x2	#3 NGP50791 28.75" x 2.25" x 3" 1/2" MDF  LEFT LEG x2	#4 NGP5080 22" x 23.625" 1/8" MDF  LEG PANEL x2	#5 NGP50702 8" x 3.5" x 2.5" ABS Plastic  GOAL x2	#9 NGP5070 2.875" Dia. ABS Plastic w/ Felt Pad  STRIKER x2	#10 NGP5071 2.5" Dia. x 1/8" ABS Plastic  PUCK x2
#12 NGP50801 5 Blade Axial Fan Pre-installed on Table Body  BLOWER MOTOR	#13 NGP50785 1.5" Dia. x 1.75"  LEG LEVELER x4	#14 NGP50786 3.125" x 3.625" x 1.5", 2 AAA bats.  ELECTRONIC SCORER x1	#16 NGP50787 (A & B wires: 1 wire set per goal) SCORER SENSOR WIRE			

HARDWARE PACK - NGP5078 (sealed in individual numbered poly bags and then bagged as set)

#6 x12  3/16" x 1" BOLT	#7 x12  FLAT WASHER 1/4" ID, 5/8" OD	#8 x16  1/2" SCREW	#11 x1  HEX WRENCH	#15 x6  5/8" SCREW
---	---	--	--	---