

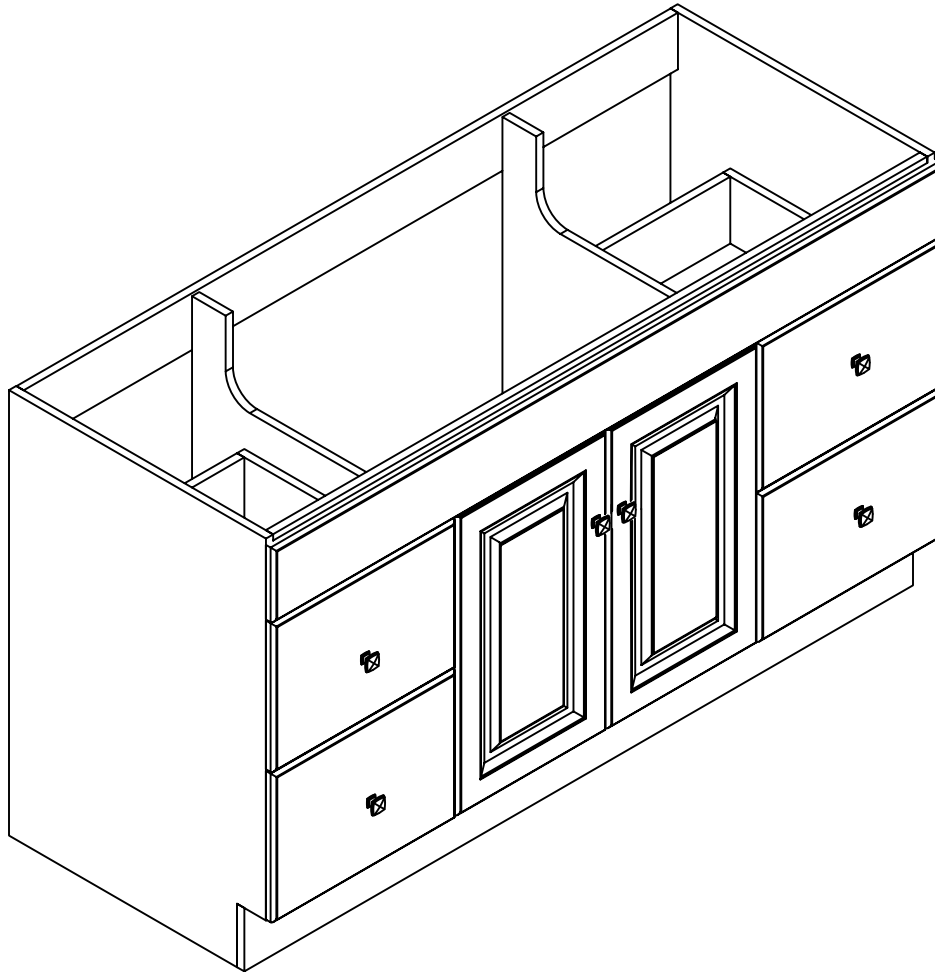

www.todaysdesignhouse.com



586016

ASSEMBLY INSTRUCTIONS

DHI Corp. • 5205 W. Donges Bay Rd. • Mequon, WI 53092 • 800.558.8700

PARTS LIST:

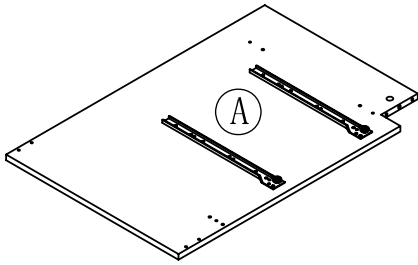

LEFT SIDE PANEL 1PC

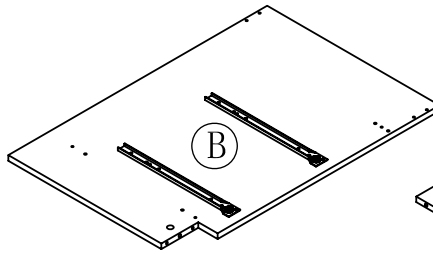

RIGHT SIDE PANEL 1PC

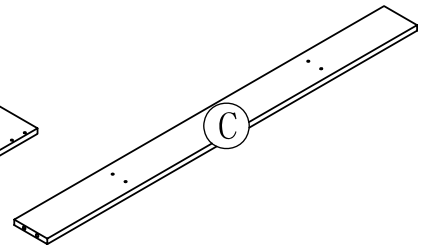

BACK CROSS BRACE 1PC

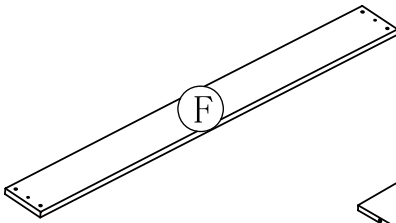

TOE KICK PANEL 1PC

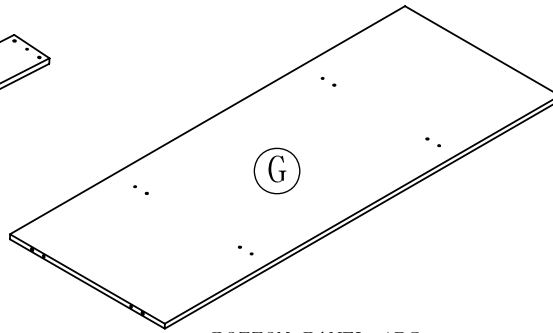

BOTTOM PANEL 1PC

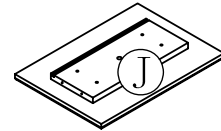

DRAWER FRONT 4PCS

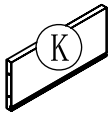

DRAWER BACK PANEL
4PCS

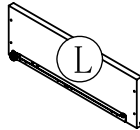

DRAWER LEFT SIDE
PANEL 4PCS

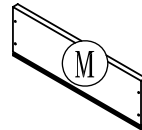

DRAWER RIGHT SIDE
PANEL 4PCS

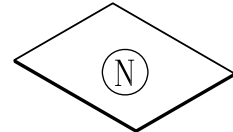

DRAWER BOTTOM
PANEL 4PCS

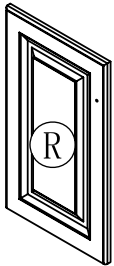

LEFT SIDE DOOR 1PC

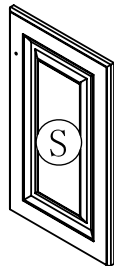

RIGHT SIDE DOOR 1PC

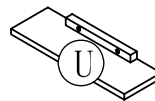

FIXED PANEL 1PC

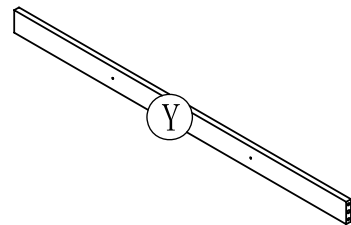

FRONT CROSS BRACE 1PC

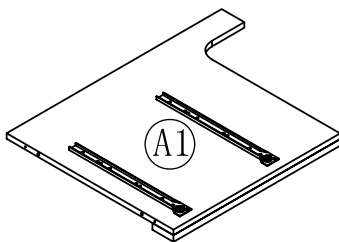

LEFT BIG PARTITION 1PC

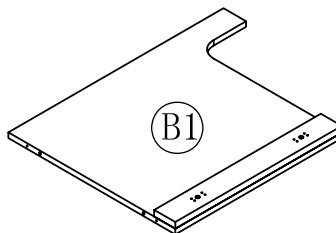

RIGHT BIG PARTITION 1PC

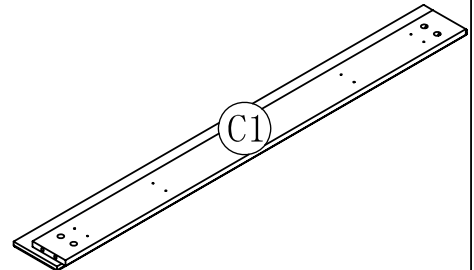

FALSE DRAWER FRONT 1PC

HARDWARE LIST:



a. WOOD DOWEL 18PCS

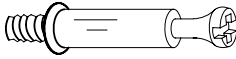

b. CAM LOCK SCREW 16PCS



c. CAM LOCK 16PCS



d. 1" L WOOD SCREW 6PCS



e. 1-1/2" L WOOD SCREW 38PCS

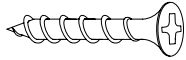

f. 5/8" L FLAT HEAD SCREW 24PCS

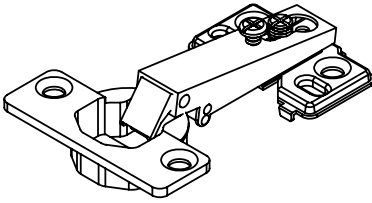

h. HINGE 4PCS

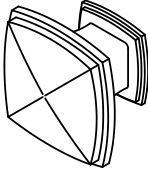

l. KNOB 6PCS

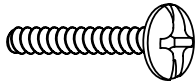

n. KNOB BOLT 6PCS



o. WRENCH 1PC



p. GLUE 1PC

STEP 1

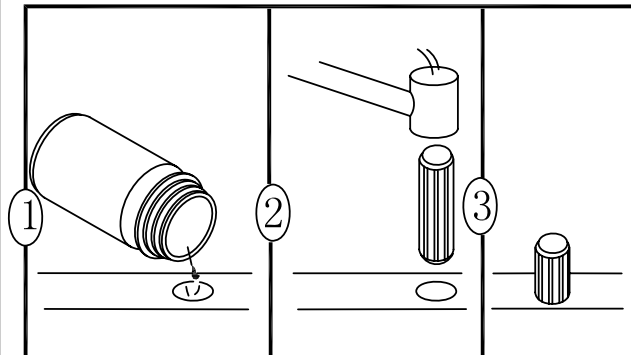
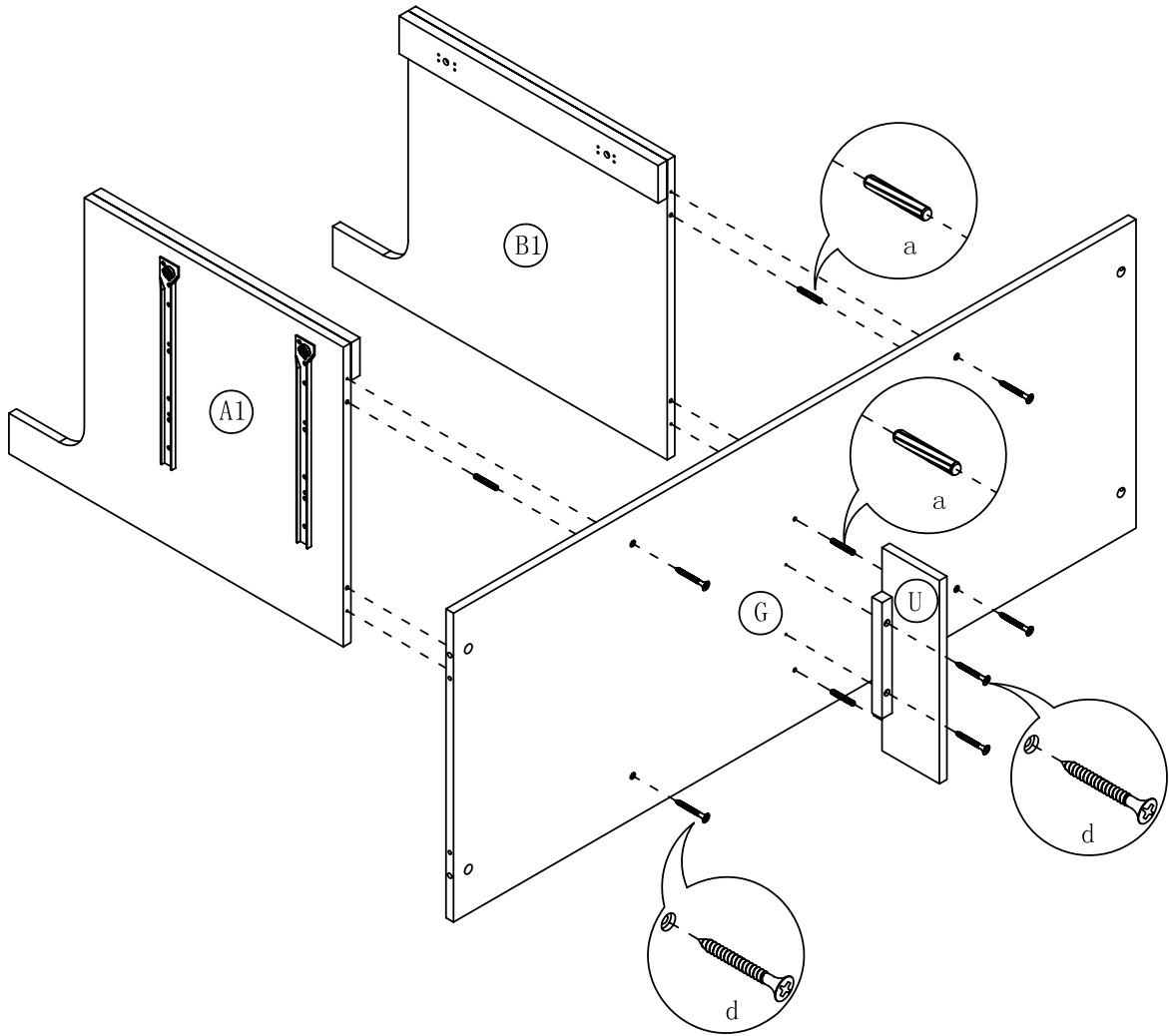

STEP 2

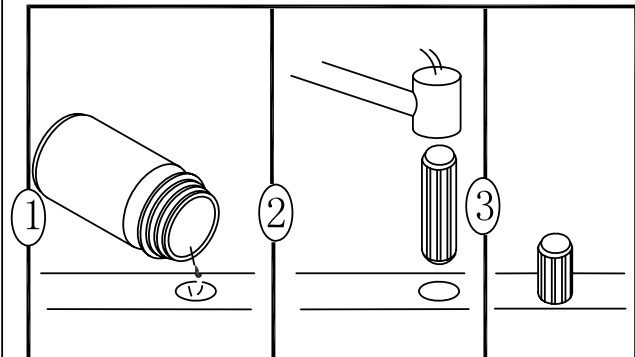
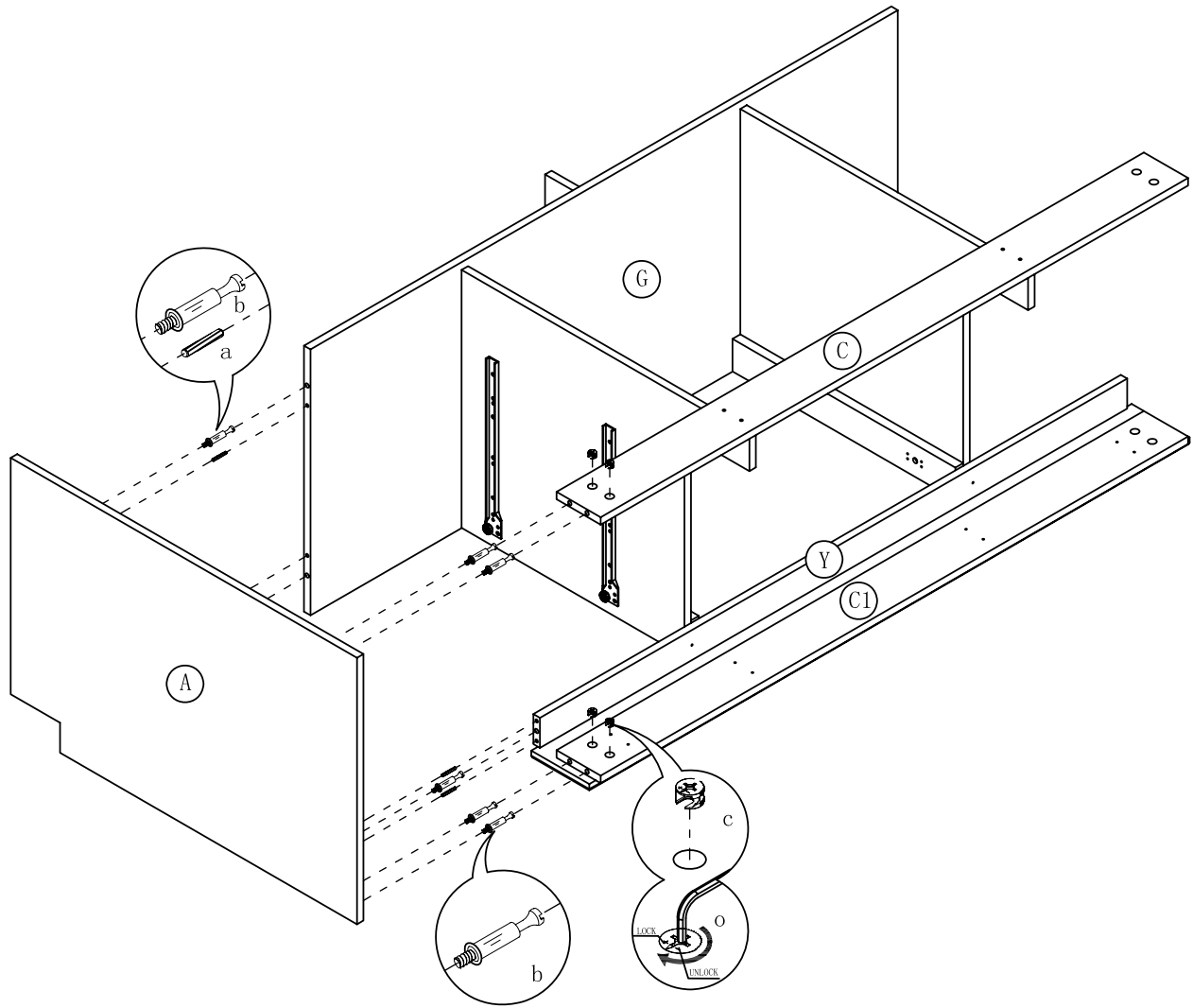

STEP 3

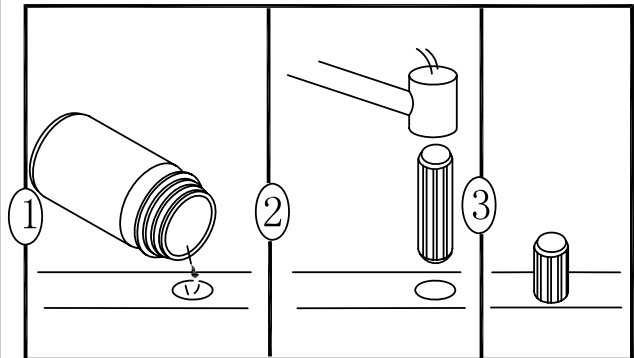
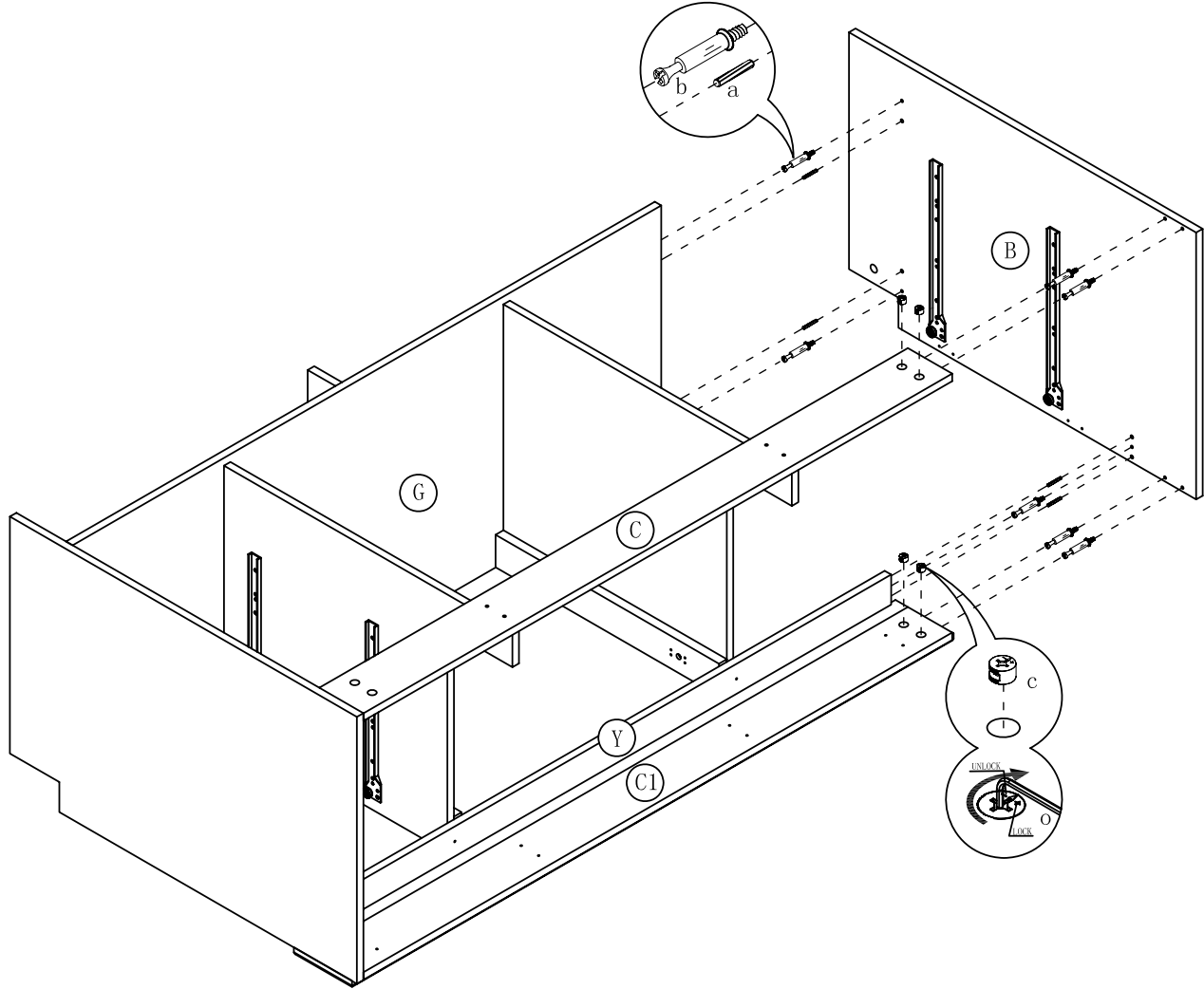

STEP 4

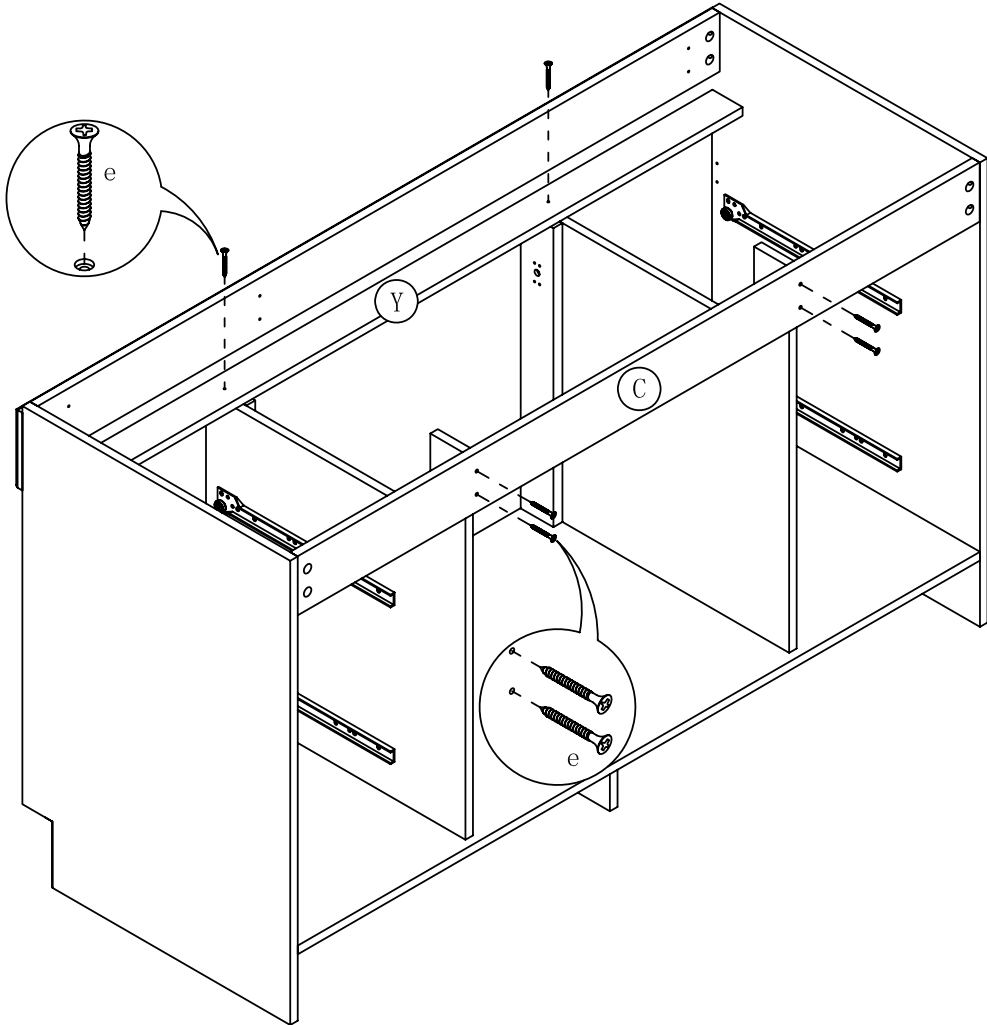

STEP 5

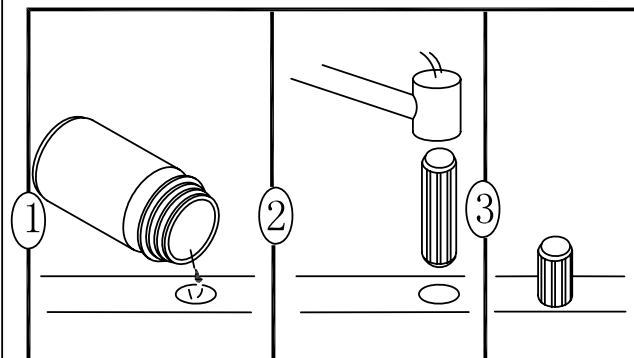
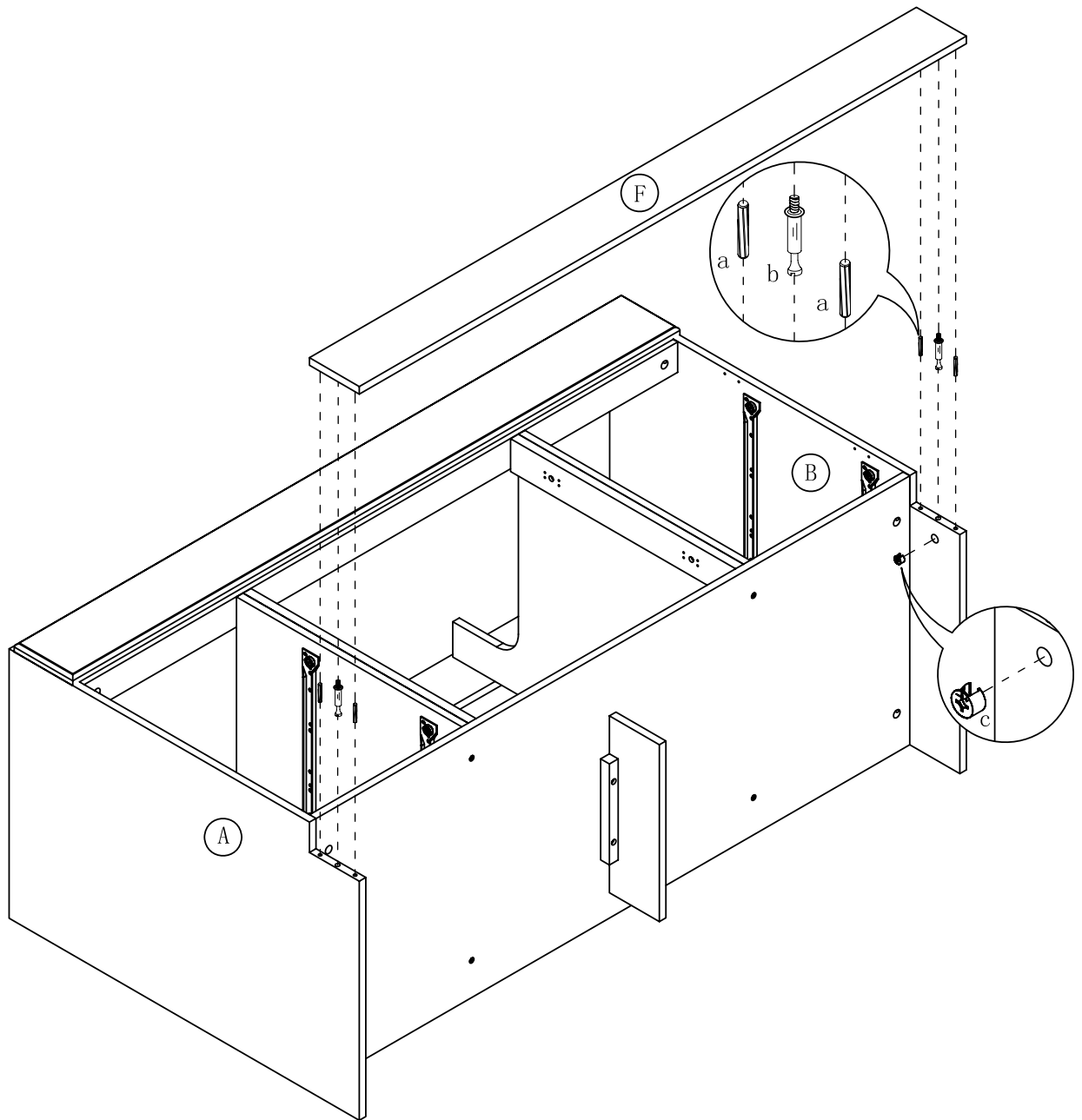

STEP 6

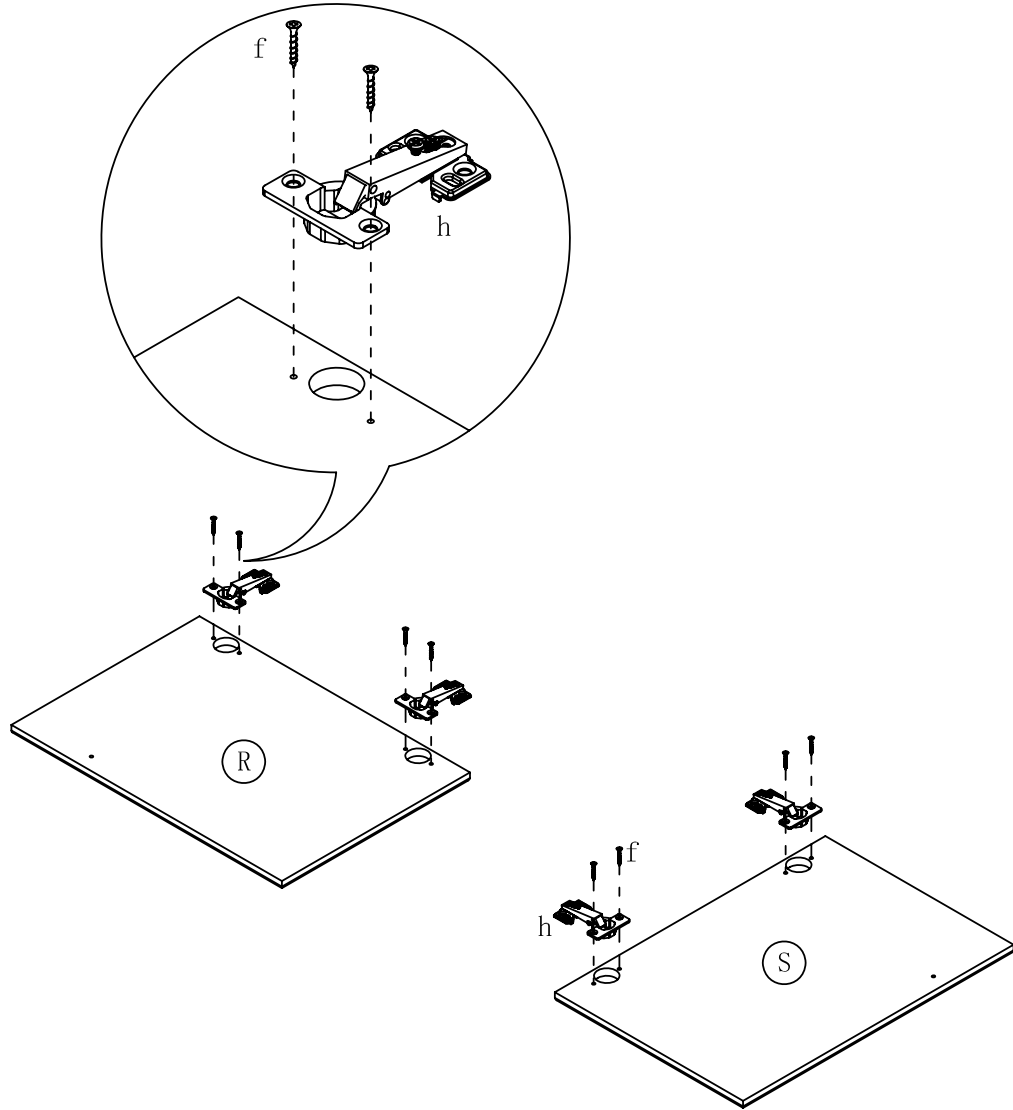

STEP 7

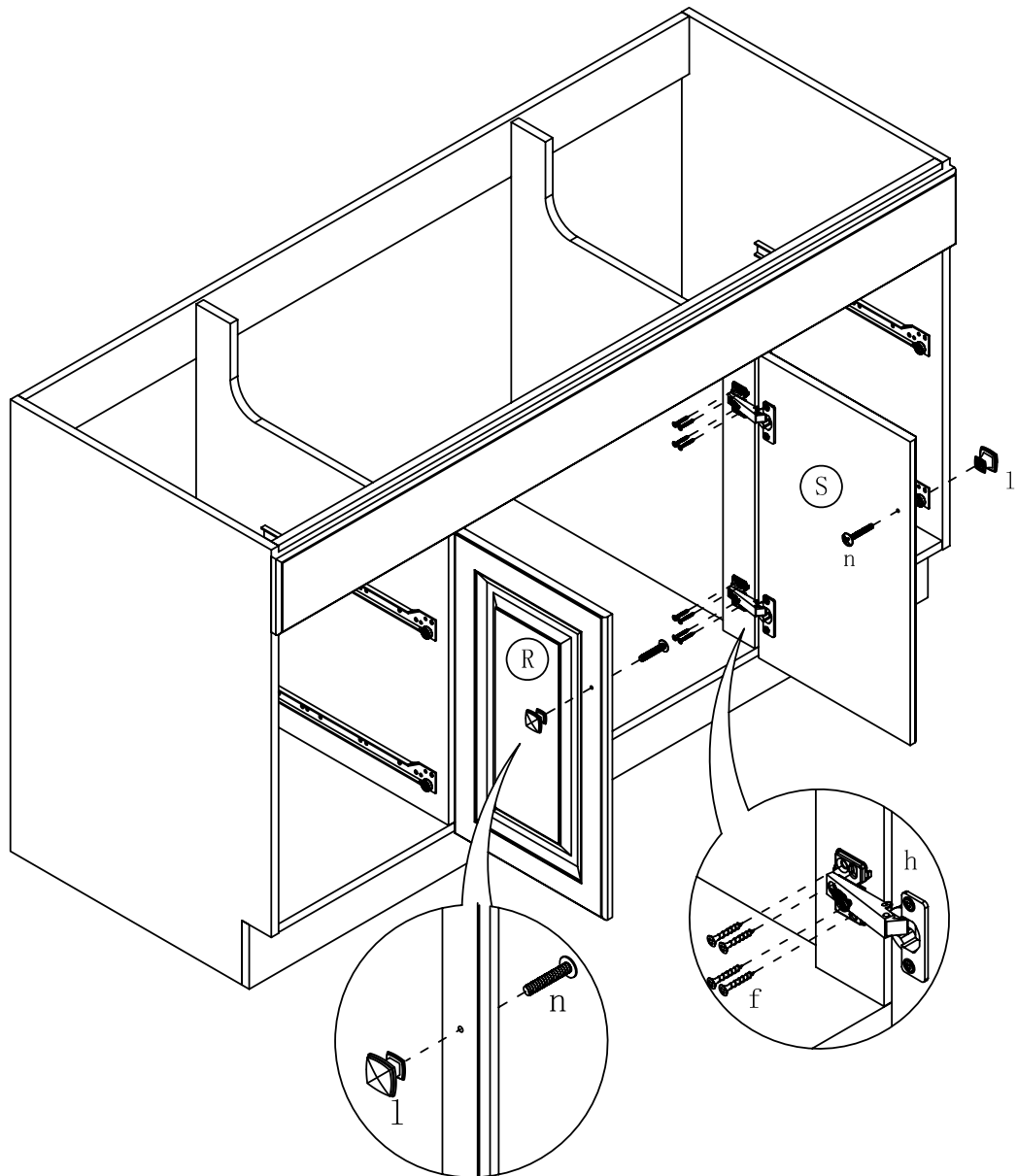

STEP 8

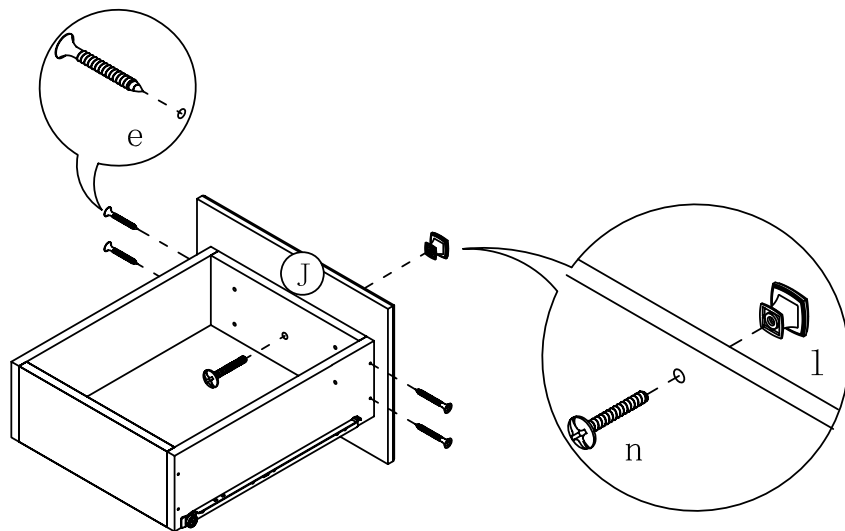
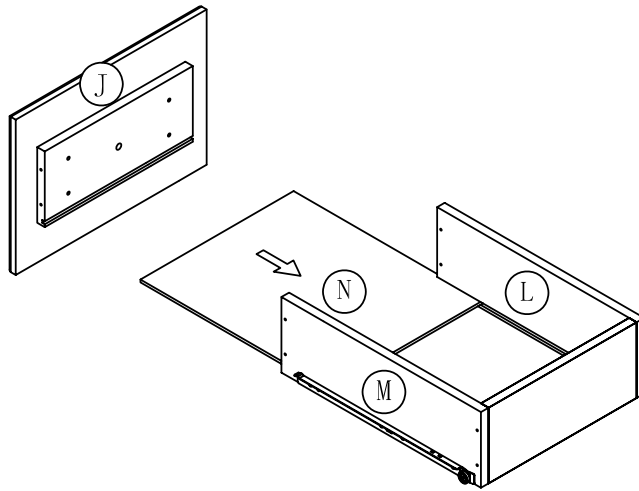
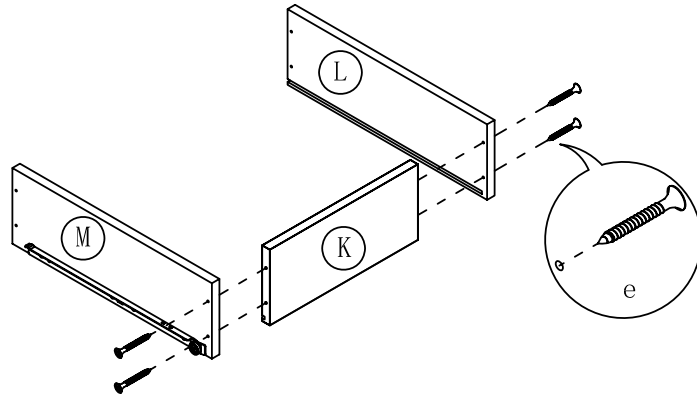

STEP 9

