

ENVIRONMENTALLY FRIENDLY, ENERGY EFFICIENT

- Lumen packages suitable for ceiling heights ranging from 8' to in excess of 100'
- Efficacies up to 123 lm/w
- Superior-quality white LED light output using Chip on Board technology
- Patented Hyperbolic Reflector (U.S. Patent No. 10,670,227 B2)
- **Low UGR:** UGR of zero for fixtures aimed at nadir with a cut-off equal to or less than 60deg per CIE 117-1995 Discomfort Glare in Interior Lighting.

PRODUCT SPECIFICATIONS

Atrius™ - Ready Product: Select models of the L-series product line deliver valuable data and connectivity to the Atrius IoT location based platform services. For more information, please refer to www.acuitybrands.com/Atrius.

OPTICS

Hyperbolic: Patented hyperbolic shape (U.S. Patent No. 10,670,227 B2) optimized for small, directional LED source, maximizes fixture efficiency while creating the "Silent Ceiling" appearance by reducing lamp image and aperture brightness • Geometry of hyperbolic curve provides unique aperture appearance and smoother light distribution

Parabolic/Lens: Computer-optimized parabolic reflector with frosted convex lens regressed into cone provides uniform distribution with no striations

Wall Wash: Available in Hyperbolic and Parabolic. Both providing uniform distributions with no striations

ELECTRICAL

LED Light Engine: Compact light source delivers uniform illumination without pixilation, enabling excellent beam control • 2SDCM (5000K within 3SDCM) • 80, 90 & 97 CRI • Replaceable light engine with push in wire connections mounts directly to heat sink and is easily replaceable

Passive Cooling: Aluminum heat sink integrated directly with housing provides superior thermal management to ensure the long life of LED

LED Driver: Power factor >0.9 • Easily replaceable from above or below the ceiling

Dimming: Dimmable via 0-10V protocol standard • Optional drivers available for use with eldoLED, Lutron EcoSystem, 2-wire dimmers, DMX, or DALI • For a list of compatible dimmers, see [LED-DIM](#).

Life: Rated for 60,000 hours at 70% lumen maintenance

Emergency Battery Pack (Optional) output: Provides a minimum of 600 (BR & BRT20C), or 1000 (HBR) lumens for a minimum duration of 90 minutes • BRT20C option is CEC Title 20 compliant

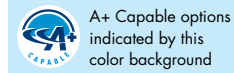

J7.1.2G4

800 TO 9000 LUMEN 8" LED
NEW CONSTRUCTION/REMODEL
 HYPERBOLIC / PARABOLIC / WALLWASH
L8 / LRM8 SERIES

Type	Cat. No.
_____	_____
Project: _____	
Notes: _____	

BUY AMERICAN ACT: This product is assembled in the USA and meets the Buy America(n) government procurement requirements under FAR, DFARS and DOT regulations. Please refer to www.acuitybrands.com/buy-american for additional information.

Warranty: 5 years when used in accordance with manufacturing guidelines. This is the only warranty provided and no other statements in this specification sheet create any warranty of any kind. All other express and implied warranties are disclaimed.

Note: Actual performance may differ as a result of end-user environment and application. Specifications subject to change without notice.

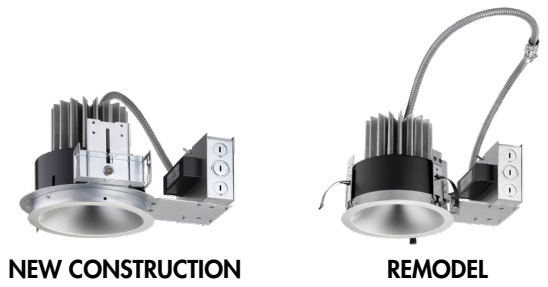

ORDERING INFORMATION Complete Catalog# Example Includes (Rough-In, option, reflector, accessory) Ordering Example: L8 08LM 27K MVOLT G4 80CRI ZT HW CS PF HBTL

ROUGH-IN

Series	Light Engine	Color Temperature	Voltage	Generation	CRI	Driver	Rough-In Options
L8	8" L-Series New Construction Downlight	08LM	27K 2700K	G4	80CRI	DALI	F3.8 Fuse and Fuse Holder
		13LM	30K 3000K		90CRI	DMXR	
LRM8	8" L-Series Remodel Rough-in	15LM	35K 3500K	G4	97CRI ²	EDAB ¹⁸	BR ^{3,11} 600 Lumen Emergency Battery Pack w/Remote Test Switch
		17LM	40K 4000K		MVOLT ¹	EDXB ⁵	BRT20C ^{3,11} 600 Lumen Emergency Battery Pack w/ Remote Test Switch, CEC Title 20 Compliant
		23LM	50K 5000K		(120-277)	EZ10 ¹⁸	HBR ^{3,11} 1000 Lumen Emergency Battery Pack w/Remote Test Switch
		28LM				EZ1 ¹⁸	NL ^{8,10} nLight® Dimming Pack Controls
		33LM				EZB ¹⁸	NLER ^{8,10} nLight® dimming pack controls. nLER controls fixtures on emergency circuit
		40LM				FD ^{4,6}	NLTAIR2 ^{10,16} nLight® AIR Dimming Pack Wireless Controls
		45LM				ECOD ^{7,13,19}	NLTAIRER2 ^{3,10,16} nLight® AIR Dimming Pack Wireless Controls. Controls fixtures on emergency circuit
		50LM				ZT	AE2CD ^{15,16} Atrius™ - Ready, VLC Commissioning, Radio (BT Positioning)
		55LM				GZ1 ⁴	
		60LM					
		65LM					
		70LM					
		75LM					
		80LM					
85LM							
90LM							

REFLECTOR To order reflector separately, use "L8" prefix before reflector option values. Ex: L8 HW CS PF

Trim Style	Finish	Trim Options	Mounting
HM ¹¹ Hyperbolic Medium HW ¹¹ Hyperbolic Wide HWS ¹¹ Hyperbolic Single Wall Wash	P Parabolic WPR ¹⁷ Parabolic Wide WC ¹¹ Corner Wall Wash WD ¹¹ Double Wall Wash WS ¹¹ Single Wall Wash	BD Black Diffuse BS Black Specular CD Clear Diffuse CS Clear Specular CSS Clear Semi-Specular GD Gold Diffuse GS Gold Specular PTD Pewter Diffuse PTS Pewter Specular WH White, White Flange WTD Wheat Diffuse WTS Wheat Specular	PF ¹² White Flange WET Wet Location Blank Flanged

Accessories ¹⁷			
HB28 ¹⁴	28" C-Channel Bar Hangers, Pair	INSA8/05 ¹⁴	8" Sloped Ceiling Adapter, 5° Angle
HB52 ¹⁴	52" C-Channel Bar Hangers, Pair	INSA8/10 ¹⁴	8" Sloped Ceiling Adapter, 10° Angle
HBTU ¹⁴	25" Tru-Lock Grid Ceiling Bar Hanger, Pair	INSA8/15 ¹⁴	8" Sloped Ceiling Adapter, 15° Angle
LB27 ¹⁴	27" Linear Bar Hangers, Pair	INSA8/20 ¹⁴	8" Sloped Ceiling Adapter, 20° Angle
		INSA8/25 ¹⁴	8" Sloped Ceiling Adapter, 25° Angle
		INSA8/30 ¹⁴	8" Sloped Ceiling Adapter, 30° Angle

Ordering Notes

- 1 MVOLT not available for 85LM and up.
- 2 2700K & 3000K only.
- 3 Not available with 347V.
- 4 Not available for 60LM and up.
- 5 Not available for 40LM and 55LM and up.
- 6 120V only.
- 7 Not available for 50LM and up.
- 8 Specify voltage.
- 9 See CP notes in following table for compatibility with other options.
- 10 Only compatible with the following driver options: EZ1, EZB, EZ10, GZ1; ZT (for 60LM - 90LM only).
- 11 Not compatible with WET.
- 12 PF not available with WH finish. When specifying WH finish, flange is always painted white.
- 13 Not compatible with BR, BRT20C, or HBR.
- 14 Not compatible with LRM8.
- 15 See AE2CD notes in following table for compatibility with other options.
- 16 NLTAIR2, NLTAIRER2, AE2CD not recommended for metal ceiling installations
- 17 NPR, WPR available with CS, CSS, CD, WH finishes only.
- 18 Not available for 85LM and up.
- 19 ECOD with MVOLT only available for 08LM - 17LM.

CP Notes

CP with MVOLT only available for 08LM - 17LM.
 BR, BRT20C, HBR, EDXB, NL, NLER, NLTAIR2, NLTAIRER2, AE2CD not compatible with CP.

AE2CD Notes

Not available with 347 for LRM8 series.
 Only compatible with EZ1 driver for 55LM and below.
 CP, BR, BRT20C, HBR, NL, NLER, NLTAIR2, NLTAIRER2 not compatible with AE2CD.
 Recommended ceiling height of 30' and under; not intended for use on ceilings greater than 40' or metal ceiling installations.

The Bluetooth® word mark and logos are registered trademarks owned by Bluetooth SIG, Inc. and any use of such marks by Acuity Brands Lighting is under license.

PRODUCT SPECIFICATIONS (cont.)

MECHANICAL

New Construction Housing: Low profile, universal housing design installs in suspended grid, plaster or drywall • Integral heat sink conducts heat away from LED light engine • Driver is accessible from above and below ceiling and can be upgraded to accommodate future technology improvements

Mounting Frame: Heavy gauge steel lower housing ring accommodates ceilings up to 2" thick • For thicker ceilings; consult factory

Mounting Bracket: New Construction mounting brackets have 3" vertical adjustment and accepts most commercial bar hangers, including our proprietary Tru-Lock bar hangers • Our one-piece Tru-Lock bar hangers have integral T-bar locking screws and alignment notches for locating and locking fixture in the center or 1/4" tile increments

Junction Box: Over size 4" x 6" galvanized steel junction box with (6) 1/2" (2) 3/4" knockouts facilitate quick wiring • New Construction junction box rated for four (4) No. 12 AWG 90° C branch circuit conductors (2-in, 2-out)

Remodel Housing: Housing installs from below ceiling in applications where above ceiling access is not available • Secured in place by factory installed remodel springs • Remodel springs accommodate ceilings from 1/2" to 1-1/8" thick • Integral heat sink conducts heat away from LED light engine • Driver is accessible from below the ceiling and can be upgraded to accommodate future technology improvements.

TRIMS:

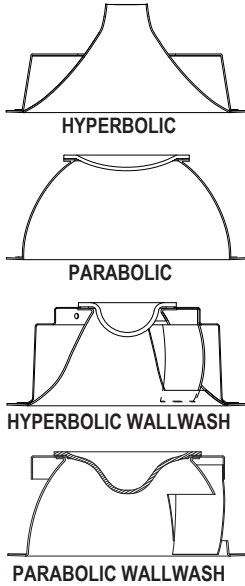

APERTURE: 7-3/8" Dia.
 CEILING CUTOUT: 8" Dia.
 OVERLAP TRIM: 8-5/8" Dia.

NEW CONSTRUCTION

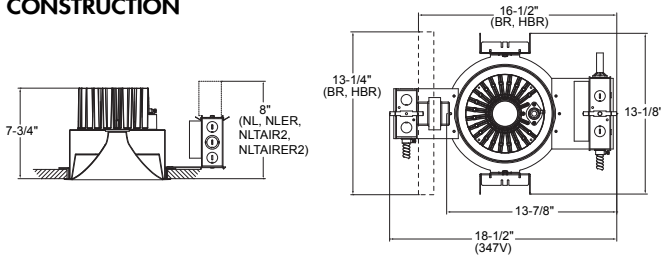

Atrius Enabled

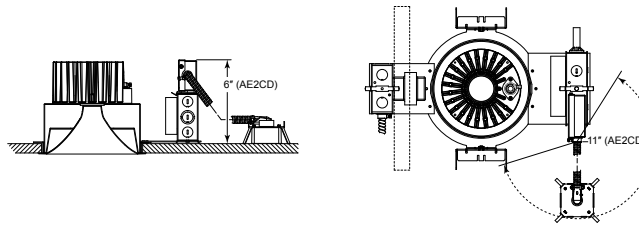

REMODEL

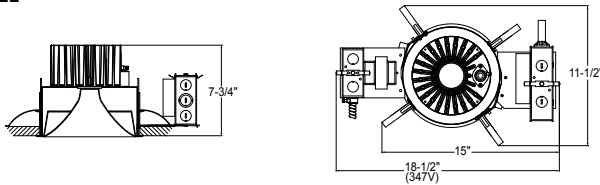

Atrius Enabled

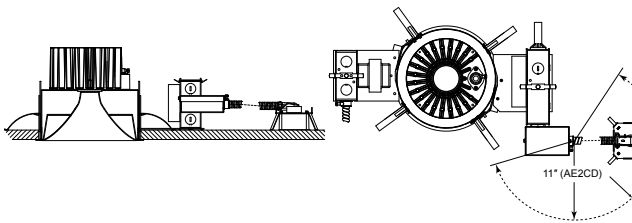

ENERGY STAR® certified

	PRODUCT#	FIXTURE CONFIGURATIONS = ENERGY STAR
	(S) (WW)LM (XX)K (V) G4 (YY)CRI (UU) (ZZ) (CC)	Series: S = L8, LRM8 Lumen Package: WW = 08, 13, 15, 17, 23, 28, 33, 40, 45, 55, 65, 75, 80, 85, 90 CCT: XX = 27, 30, 35, 40, 50 Voltage: V= MVOLT, 120, 277 CRI: YY = 80, 90, 97 Driver: UU = FD, DALI, EZ1, EZ10, EZB, ZI, GZ1 Trim Type: ZZ = HN, HM, HW, P, NPR, WPR Trim Color/Finish: CC = CS, CSS, CD

LABELS AND LISTINGS

• Tested to UL1598 and CSA C22.2 250 and listed for feed through and damp locations • Spacing requirement for 40LM and above: minimum of 4' between fixture centers, 3" overhead clearance, 2' from fixture center to side wall • RoHS compliant • EMI complies with FCC 47, Part 15, Class A • ENERGY STAR® certified, see table for designated products • I.B.E.W. Union made • ARRA Compliant 

PERFORMANCE

LIGHT ENGINE	08LM	13LM	15LM	17LM	23LM	28LM	33LM	40LM	45LM	50LM	55LM	60LM	65LM	70LM	75LM	80LM	85LM	90LM	
120V (50/60HZ)																			
INPUT CURRENT	0.063	0.098	0.115	0.132	0.197	0.238	0.280	0.351	0.345	0.381	0.427	0.439	0.483	0.541	0.573	0.607	0.656	0.710	
INPUT WATTAGE	7.53	11.74	13.66	15.82	23.52	28.46	33.62	42.14	41.41	45.54	51.08	52.51	58.11	64.59	68.84	72.83	78.87	85.03	
THD%	6.42	5.19	4.61	3.86	5.09	5.46	4.43	4.53	6.03	6.03	6.23	6.44	6.54	7.32	7.58	7.75	8.37	8.05	
POWER FACTOR	0.993	0.993	0.992	0.994	0.994	0.995	0.997	0.998	0.996	0.996	0.996	0.996	0.996	0.995	0.995	0.996	0.996	0.996	
277V (50/60HZ)																			
INPUT CURRENT	0.031	0.048	0.056	0.063	0.093	0.108	0.131	0.158	0.161	0.175	0.195	0.202	0.221	0.251	0.265	0.268	0.290	0.310	
INPUT WATTAGE	7.87	11.84	13.81	15.89	23.65	28.19	33.83	41.68	41.74	45.80	51.02	52.35	57.64	64.22	68.40	71.29	77.27	83.16	
THD%	12.00	11.62	11.31	11.34	9.93	9.04	10.48	8.79	9.15	8.07	9.85	11.12	10.97	13.07	12.83	12.96	13.53	12.56	
POWER FACTOR	0.904	0.885	0.887	0.907	0.918	0.943	0.932	0.953	0.934	0.943	0.944	0.933	0.942	0.921	0.931	0.957	0.962	0.965	
HYPERBOLIC REFLECTOR: L8 HW CS (35K 80CRI)																			
DELIVERED LUMENS (L8 HW CS)	833	1,390	1,606	1,828	2,461	2,968	3,454	4,199	4,596	5,030	5,570	5,784	6,333	6,932	7,257	7,699	8,500	8,948	
EFFICACY (LPW)	111	118	118	116	105	104	103	100	111	110	109	110	109	107	105	106	108	105	
PARABOLIC REFLECTOR: L8 P CS (35K 80CRI)																			
DELIVERED LUMENS (L8 P CS)	653	1,089	1,259	1,433	1,929	2,326	2,389	3,292	3,677	4,024	4,456	4,628	5,067	5,546	5,807	6,160	6,800	7,160	
EFFICACY (LPW)	87	93	92	91	82	82	71	78	89	88	87	88	87	86	84	85	86	84	

OPTICAL DISTRIBUTIONS

HYPERBOLIC BEAM SPREAD		
Trim	08LM - 40LM	45LM-90LM
L8 HN CS	15°	25°
L8 HN CSS	19°	30°
L8 HN CD	30°	45°
L8 HM CS	57°	62°
L8 HM CSS	57°	62°
L8 HM CD	62°	65°
L8 HW CS	71°	74°
L8 HW CSS	71°	74°
L8 HW CD	71°	74°

PARABOLIC BEAM SPREAD		
Trim	08LM - 40LM	45LM-90LM
L8 NPR CS	37°	39°
L8 NPR CSS	36°	44°
L8 NPR CD	56°	61°
L8 P CS	55°	55°
L8 P CSS	58°	61°
L8 P CD	69°	73°
L8 WPR CS	84°	83°
L8 WPR CSS	83°	83°
L8 WPR CD	83°	84°

LUMEN MULTIPLIERS

CCT	MULTIPLIER
2700K	0.90
3000K	0.96
3500K	1.00
4000K	1.01
5000K	1.04

CRI	MULTIPLIER
80CRI	1.00
90CRI	0.83
97CRI	0.77

HYPERBOLIC TRIM	MULTIPLIER
L8 HN CS	0.96
L8 HN CSS	0.87
L8 HN CD	0.81
L8 HM CS	0.99
L8 HM CSS	0.96
L8 HM CD	0.89
L8 HW CS	1.00
L8 HW CSS	0.98
L8 HW CD	0.87

PARABOLIC TRIM	MULTIPLIER
L8 NPR CS	0.94
L8 NPR CSS	1.00
L8 NPR CD	0.94
L8 P CS	1.00
L8 P CSS	0.97
L8 P CD	0.94
L8 WPR CS	0.98
L8 WPR CSS	0.96
L8 WPR CD	0.91

Applying Lumen Multipliers to Calculate Delivered Lumens								
Base Fixture Delivered Lumens (from Performance Table)	x	CCT Multiplier	x	CRI Multiplier	x	Trim Multiplier	=	Delivered Lumens for Desired Fixture and Reflector
Hyperbolic Reflector Example: L8 23LM 30K MVOLT 90CRI G4 ZT HM CD								
2461 Lumens	x	0.96	x	0.83	x	0.89	=	1745 Lumens
Parabolic Reflector Example: L8 23LM 30K MVOLT 90CRI G4 ZT NPR CD								
1929 Lumens	x	0.96	x	0.83	x	0.94	=	1445 Lumens

HYPERBOLIC PHOTOMETRICS

Distribution Curve Distribution Data Output Data Coefficient of Utilization Illuminance Data at 30" Above Floor for a Single Luminaire

L8 13LM 35K + L8 HN CS, 3500K LEDs, input watts: 11.74, delivered lumens: 1210.7, LM/W = 103.1, Spacing Criteria: 0.2, test no. PR0717186, tested in accordance to IESNA LM-79.

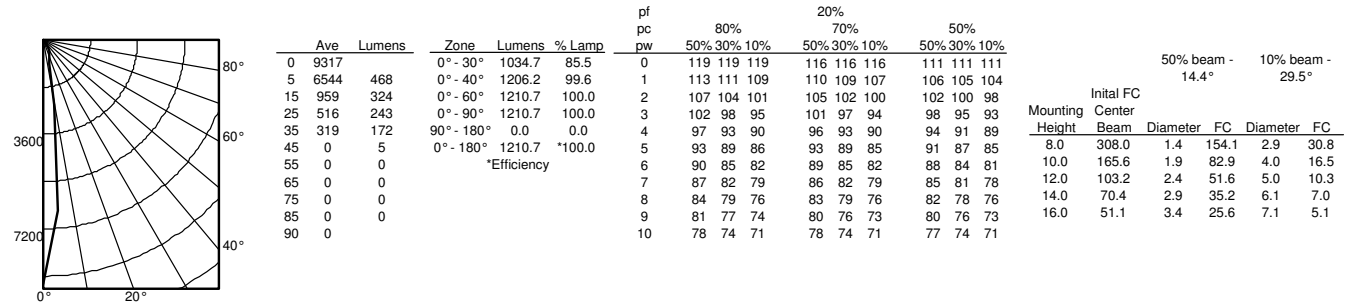

L8 13LM 35K + L8 HM CS, 3500K LEDs, input watts: 11.74, delivered lumens: 1345.2, LM/W = 114.6, Spacing Criteria: 0.8, test no. PR0717181, tested in accordance to IESNA LM-79.

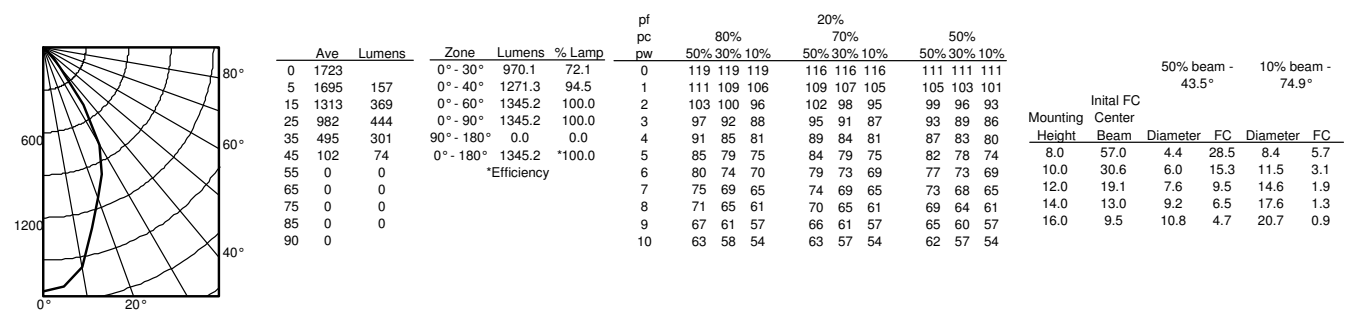

L8 13LM 35K + L8 HW CS, 3500K LEDs, input watts: 11.74, delivered lumens: 1338.7, LM/W = 114.0, Spacing Criteria: 1.1, test no. PR0717184, tested in accordance to IESNA LM-79.

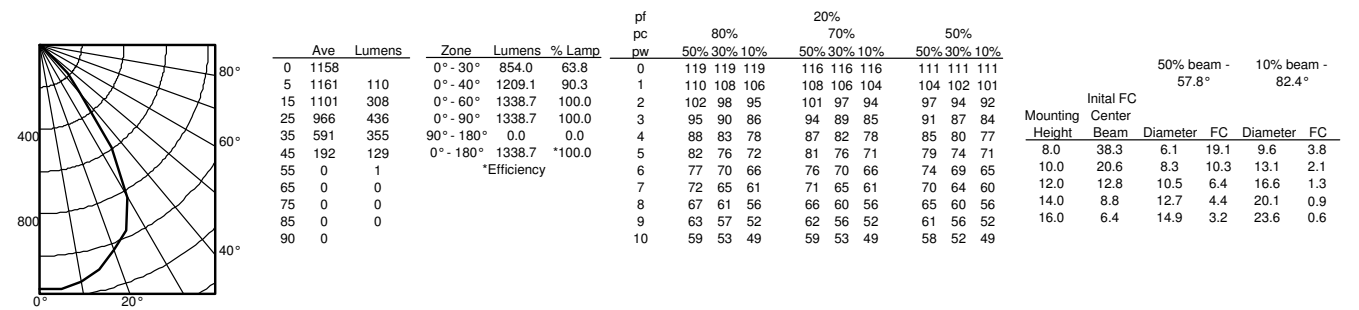

HYPERBOLIC PHOTOMETRICS

Distribution Curve Distribution Data Output Data Coefficient of Utilization Illuminance Data at 30" Above Floor for a Single Luminaire

L8 45LM 35K + L8 HN CS, 3500K LEDs, input watts: 41.41, delivered lumens: 4333.7, LM/W = 104.7, Spacing Criteria: 0.4, test no. PR07171383, tested in accordance to IESNA LM-79.

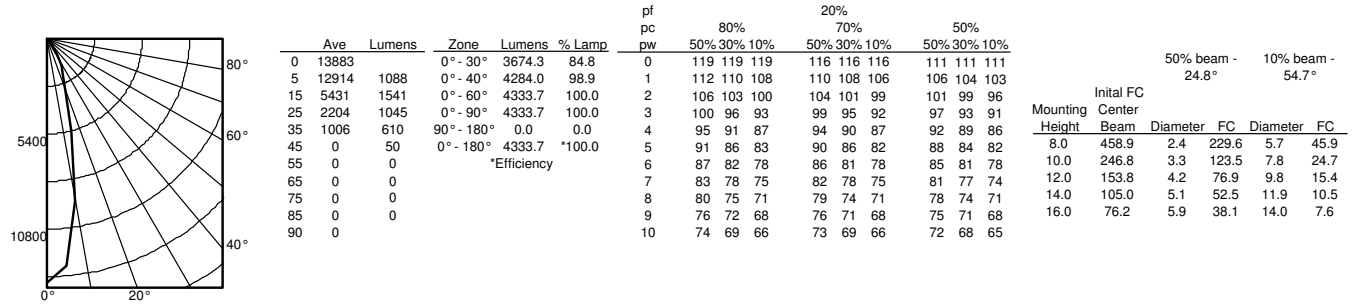

L8 45LM 35K + L8 HM CS, 3500K LEDs, input watts: 41.41, delivered lumens: 4470.1, LM/W = 107.9, Spacing Criteria: 1.0, test no. PR07171284, tested in accordance to IESNA LM-79.

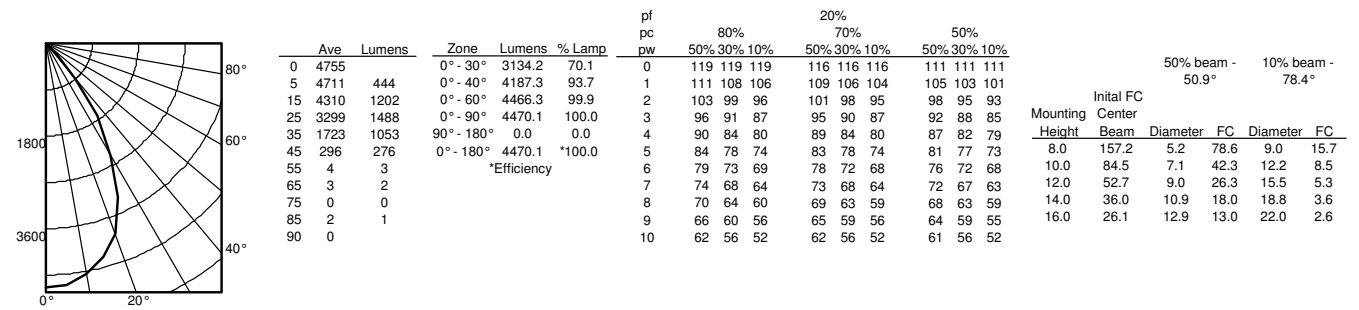

L8 45LM 35K + L8 HW CS, 3500K LEDs, input watts: 41.41, delivered lumens: 4510.0, LM/W = 108.9, Spacing Criteria: 1.2, test no. PR07171281, tested in accordance to IESNA LM-79.

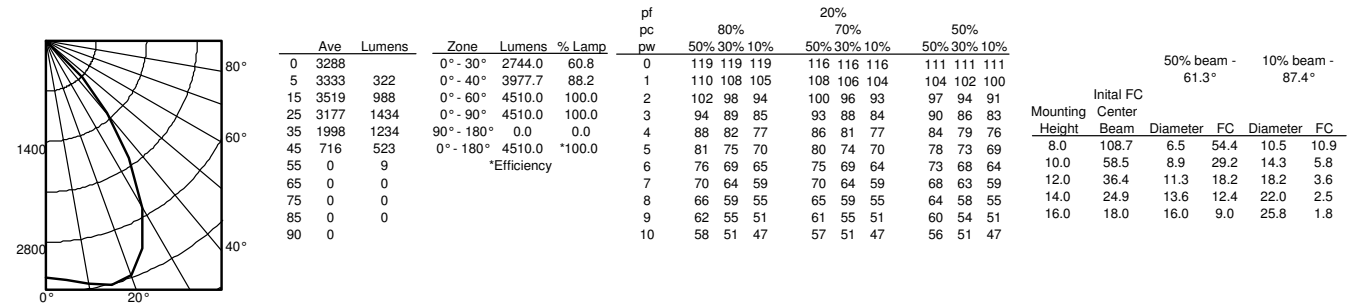

HYPERBOLIC PHOTOMETRICS

Distribution Curve Distribution Data Output Data Coefficient of Utilization Illuminance Data at 30" Above Floor for a Single Luminaire

L8 90LM 35K + L8 HN CS, 3500K LEDs, input watts: 85.03, delivered lumens: 8438.4, LM/W = 99.2, Spacing Criteria: 0.4, test no. PR07171393, tested in accordance to IESNA LM-79.

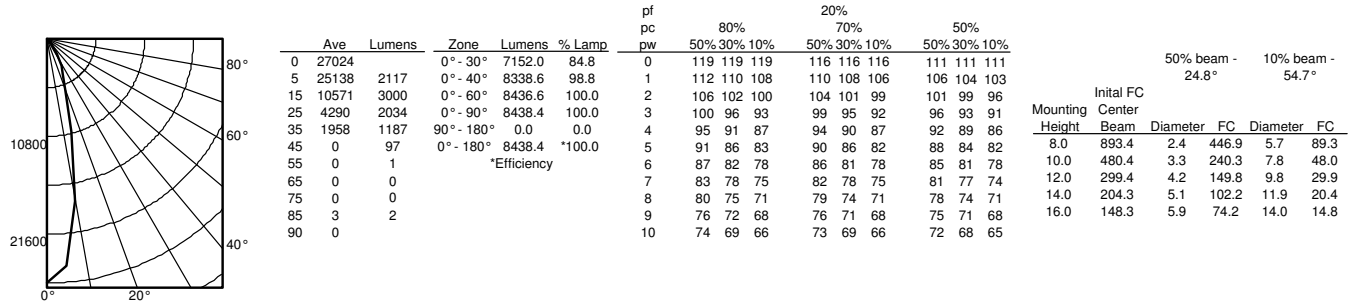

L8 90LM 35K + L8 HM CS, 3500K LEDs, input watts: 85.03, delivered lumens: 8707.0, LM/W = 102.4, Spacing Criteria: 1.0, test no. PR07171294, tested in accordance to IESNA LM-79.

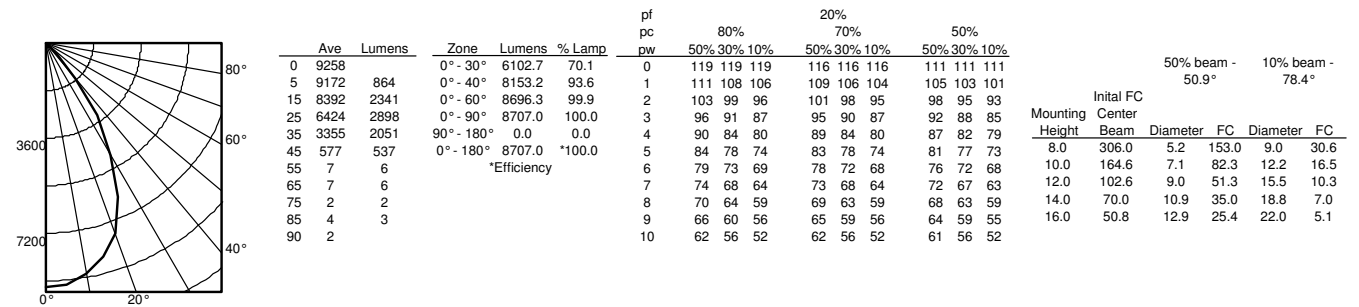

L8 90LM 35K + L8 HW CS, 3500K LEDs, input watts: 85.03, delivered lumens: 8779.7, LM/W = 103.3, Spacing Criteria: 1.2, test no. PR07171291, tested in accordance to IESNA LM-79.

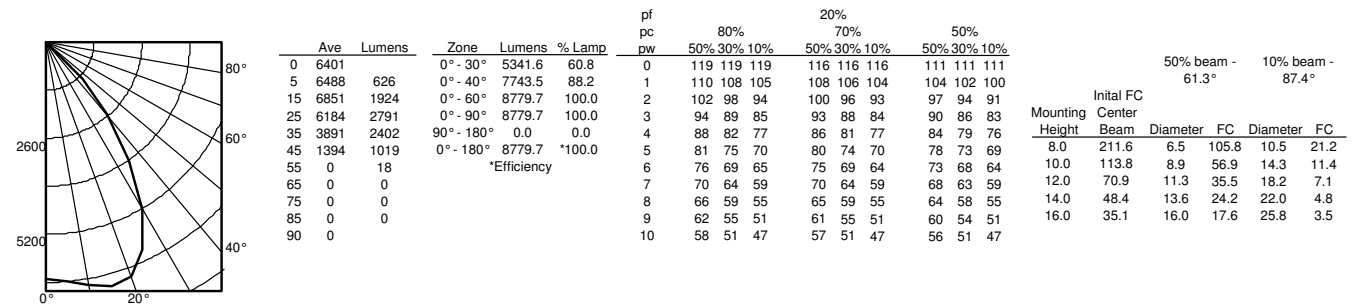

PARABOLIC PHOTOMETRICS

Distribution Curve Distribution Data Output Data Coefficient of Utilization Illuminance Data at 30" Above Floor for a Single Luminaire

L8 13LM 35K + L8 NPR CS, 3500K LEDs, input watts: 11.74, delivered lumens: 1047.8, LM/W = 89.3, Spacing Criteria: 0.6, test no. PR07171897P8, tested in accordance to IESNA LM-79.

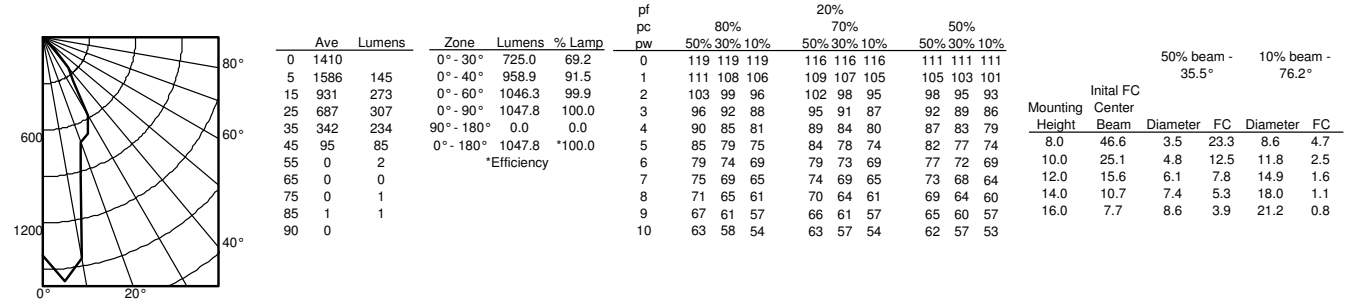

L8 13LM 35K + L8 P CS, 3500K LEDs, input watts: 11.74, delivered lumens: 1086.5, LM/W = 92.5, Spacing Criteria: 1.0, test no. PR11171591P8, tested in accordance to IESNA LM-79.

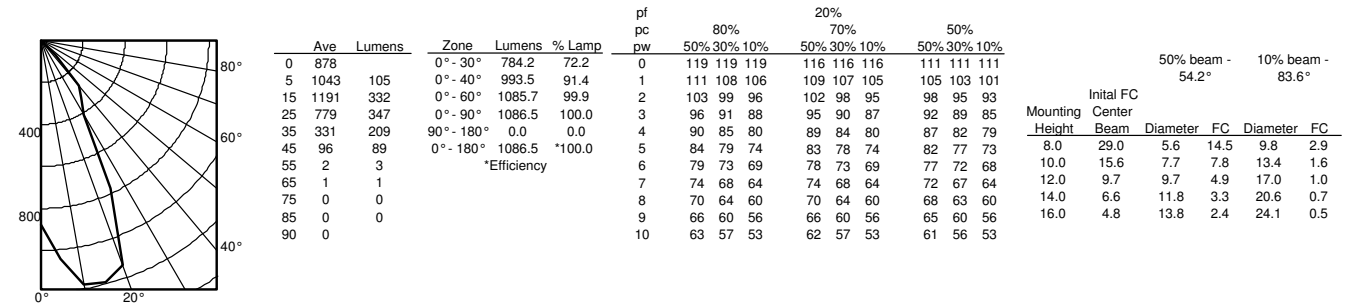

L8 13LM 35K + L8 WPR CS, 3500K LEDs, input watts: 11.74, delivered lumens: 1068.5, LM/W = 91, Spacing Criteria: 1.5, test no. PR11171594P8, tested in accordance to IESNA LM-79.

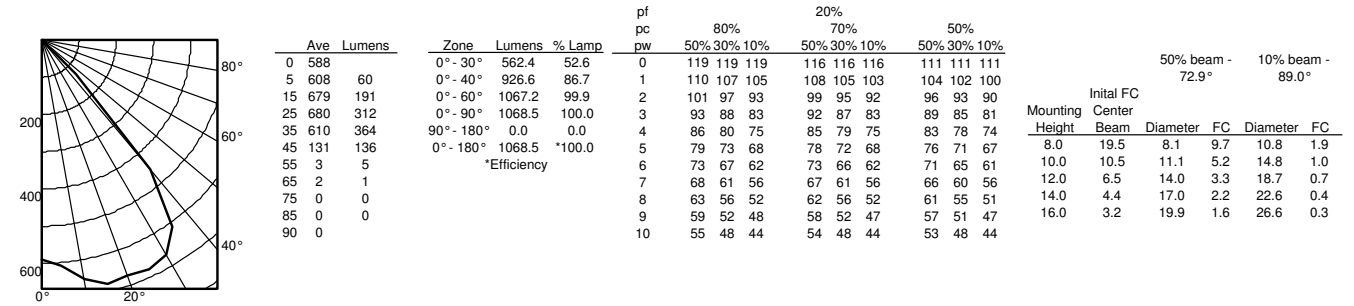

PARABOLIC PHOTOMETRICS

Distribution Curve Distribution Data Output Data Coefficient of Utilization Illuminance Data at 30" Above Floor for a Single Luminaire

L8 45LM 35K + L8 NPR CS, 3500K LEDs, input watts: 41.41, delivered lumens: 3594.5, LM/W = 87.4, Spacing Criteria: 0.6, test no. PR0717191P3, tested in accordance to IESNA LM-79.

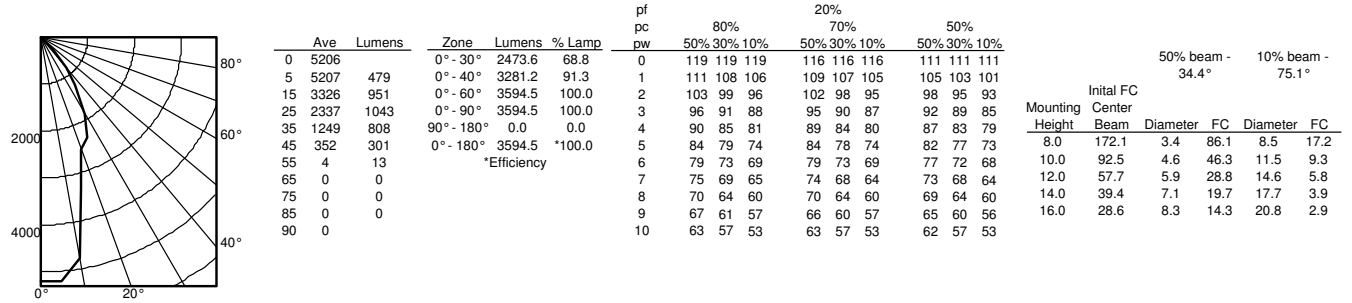

L8 45LM 35K + L8 P CS, 3500K LEDs, input watts: 41.41, delivered lumens: 3652.2, LM/W = 88.2, Spacing Criteria: 1.0, test no. PR1170994P3, tested in accordance to IESNA LM-79.

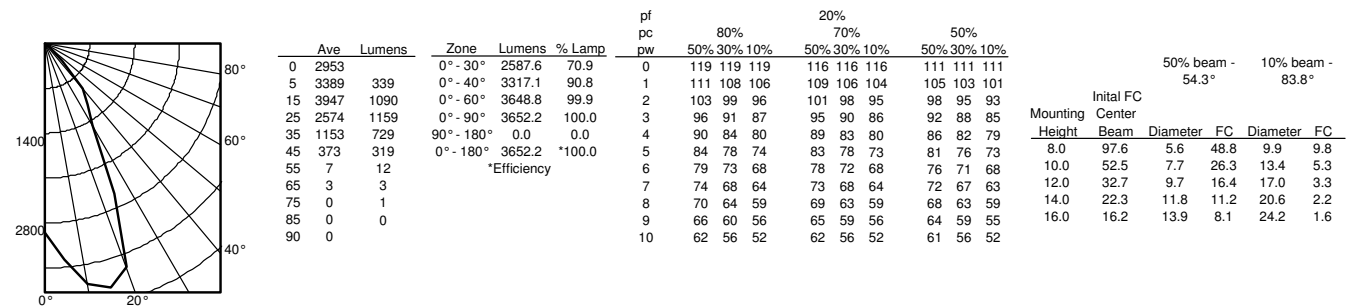

L8 45LM 35K + L8 WPR CS, 3500K LEDs, input watts: 41.41, delivered lumens: 3602.4, LM/W = 87, Spacing Criteria: 1.5, test no. PR1171092P3, tested in accordance to IESNA LM-79

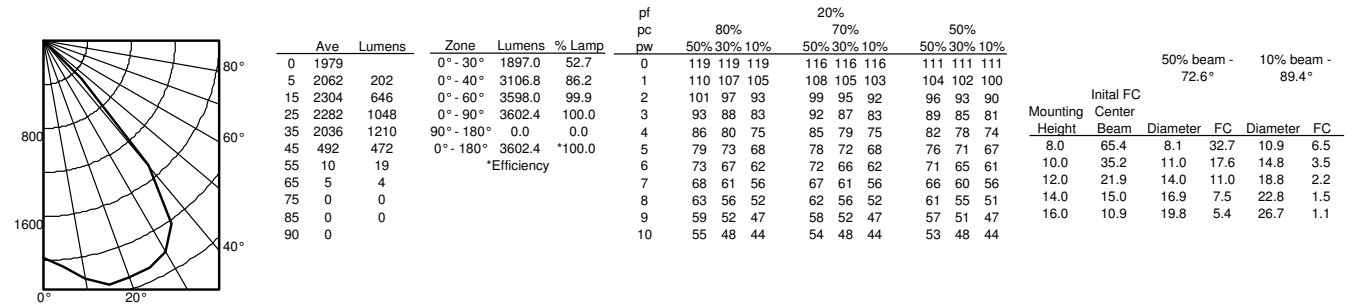

PARABOLIC PHOTOMETRICS

Distribution Curve Distribution Data Output Data Coefficient of Utilization Illuminance Data at 30" Above Floor for a Single Luminaire

L8 90LM 35K + L8 NPR CS, 3500K LEDs, input watts: 85.03, delivered lumens: 7048.0, LM/W = 82.9, Spacing Criteria: 0.6, test no. PR07171791, tested in accordance to IESNA LM-79.

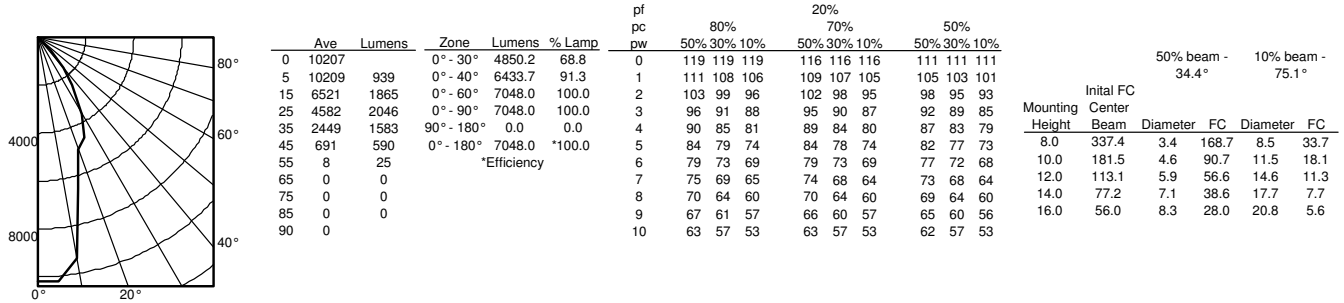

L8 90LM 35K + L8 P CS, 3500K LEDs, input watts: 85.03, delivered lumens: 7161.3, LM/W = 84.2, Spacing Criteria: 1.0, test no. PR11170994, tested in accordance to IESNA LM-79.

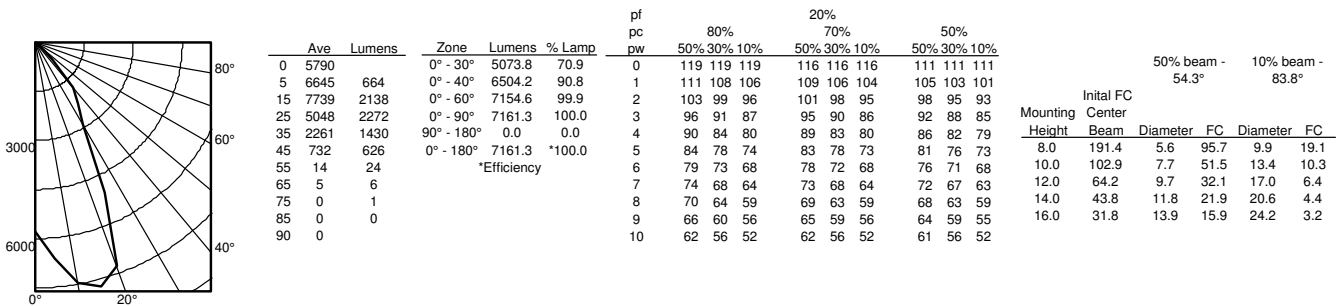

L8 90LM 35K + L8 WPR CS, 3500K LEDs, input watts: 85.03, delivered lumens: 7063.6, LM/W = 83.1, Spacing Criteria: 1.5, test no. PR11171092, tested in accordance to IESNA LM-79.

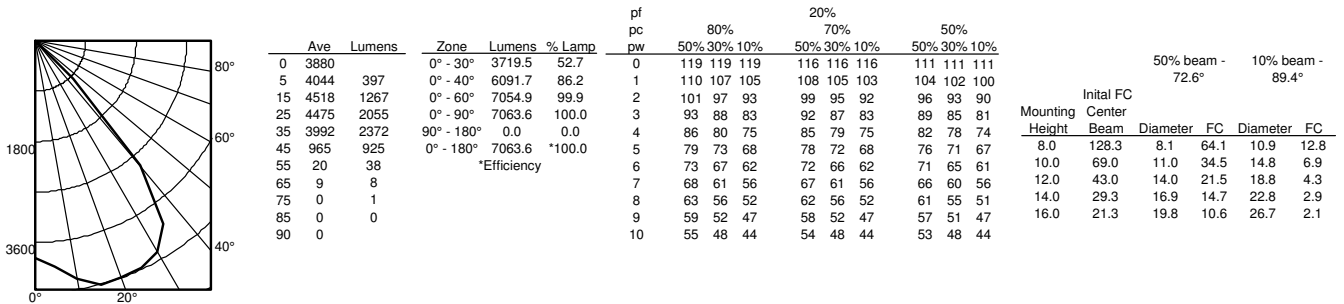

PERFORMANCE DATA

LUMINAIRES SPACED 2' FROM WALL

Catalog Number: L8 90LM 35K 120 G4 80CRI ZT; L8 HWS CSS Spread: Single Wall Test #: PR07171991

Single Unit							Lamp	Multiple Units On 2' Centers*			Multiple Units On 3' Centers*			Multiple Units On 4' Centers*		
Lateral Distance From Fixture 2' From Wall							BXRC-35E10K0-D-73-SE	Spaced 2' From Wall			Spaced 2' From Wall			Spaced 2' From Wall		
0'	1'	2'	3'	4'	5'		Distance From Ceiling	CL	CL	CL	CL	CL	CL	CL	CL	CL
123	84	36	13	6	6		1'	195	189	195	146	117	146	132	69	132
106	82	42	18	9	7		2'	193	191	193	138	126	138	118	83	118
94	71	38	19	11	8		3'	175	172	175	128	115	128	109	77	109
76	64	40	22	13	9		4'	163	163	163	115	113	115	95	80	95
51	48	36	22	14	11		5'	135	138	135	94	98	94	73	75	73
34	36	29	22	15	12		6'	107	114	107	76	83	76	57	63	57
25	28	25	19	15	12		7'	89	96	89	65	71	65	50	54	50
20	23	20	16	14	12		8'	75	81	75	55	62	55	43	45	43
15	17	16	13	11	10		9'	59	64	59	44	50	44	34	36	34
10	13	12	10	9	7		10'	43	47	43	34	38	34	25	29	25

LUMINAIRES SPACED 3' FROM WALL

Catalog Number: L8 90LM 35K 120 G4 80CRI ZT; L8 HWS CSS Spread: Single Wall Test #: PR07171991

Single Unit							Lamp	Multiple Units On 3' Centers*			Multiple Units On 4' Centers*			Multiple Units On 6' Centers*		
Lateral Distance From Fixture 3' From Wall							BXRC-35E10K0-D-73-SE	Spaced 3' From Wall			Spaced 3' From Wall			Spaced 3' From Wall		
0'	1'	2'	3'	4'	5'		Distance From Ceiling	CL	CL	CL	CL	CL	CL	CL	CL	CL
49	42	27	16	9	7		1'	79	76	79	65	56	65	53	27	53
66	59	39	23	14	10		2'	111	110	111	89	82	89	71	40	71
47	43	32	22	15	11		3'	90	89	90	71	68	71	52	37	52
47	42	31	21	15	11		4'	87	86	87	69	65	69	52	37	52
45	40	31	22	15	12		5'	87	87	87	69	67	69	50	39	50
39	36	29	22	17	13		6'	82	83	82	65	65	65	46	40	46
31	30	26	21	17	14		7'	74	76	74	58	61	58	40	39	40
24	25	22	19	15	13		8'	63	69	63	49	54	49	34	34	34
17	19	18	15	13	12		9'	51	58	51	40	45	40	28	29	28
12	14	14	11	11	10		10'	41	44	41	32	36	32	21	23	21

LUMINAIRES SPACED 4' FROM WALL

Catalog Number: L8 90LM 35K 120 G4 80CRI ZT; L8 HWS CSS Spread: Single Wall Test #: PR07171991

Single Unit							Lamp	Multiple Units On 3' Centers*			Multiple Units On 4' Centers*			Multiple Units On 6' Centers*		
Lateral Distance From Fixture 4' From Wall							BXRC-35E10K0-D-73-SE	Spaced 4' From Wall			Spaced 4' From Wall			Spaced 4' From Wall		
0'	1'	2'	3'	4'	5'		Distance From Ceiling	CL	CL	CL	CL	CL	CL	CL	CL	CL
27	24	19	14	10	8		1'	53	53	53	42	41	42	33	25	33
45	40	31	22	16	12		2'	88	88	88	70	67	70	53	41	53
38	36	30	23	17	13		3'	83	84	83	65	65	65	48	42	48
31	29	25	20	16	13		4'	71	72	71	57	56	57	41	37	41
32	29	24	19	15	13		5'	70	70	70	56	55	56	41	36	41
31	29	25	20	16	13		6'	70	71	70	56	56	56	41	37	41
29	27	23	20	16	14		7'	69	71	69	55	56	55	40	37	40
25	25	22	18	15	14		8'	66	69	66	52	54	52	37	35	37
21	20	18	16	14	12		9'	56	59	56	45	47	45	32	31	32
15	15	15	13	12	10		10'	45	46	45	36	37	36	25	26	25

*Based on minimum of five luminaires. Reflectances: 80, 50, 20. Values are rounded to nearest whole footcandle.

Fixtures tested to IES recommended standard for solid state lighting per LM-79-08. Photometric performance on a single unit represents a baseline of performance for the fixture. Results may vary in the field.

PERFORMANCE DATA

LUMINAIRES SPACED 2' FROM WALL

Catalog Number: L8 90LM 35K 120 G4 80CRI ZT; L8 WS CD Spread: Single Wall Test #: PR07171795

Single Unit							Lamp	Multiple Units On 2' Centers*			Multiple Units On 3' Centers*			Multiple Units On 4' Centers*		
Lateral Distance From Fixture 2' From Wall							BXRC-35E10K0-D-73-SE	Spaced 2' From Wall			Spaced 2' From Wall			Spaced 2' From Wall		
0'	1'	2'	3'	4'	5'	Distance From Ceiling	CL	CL	CL	CL	CL	CL	CL	CL	CL	
146	101	41	15	7	7	1'	228	220	228	171	137	171	156	79	156	
186	143	69	27	12	9	2'	330	330	330	235	213	235	204	136	204	
135	106	56	27	14	11	3'	257	258	257	184	171	184	156	113	156	
88	78	55	28	15	11	4'	207	206	207	141	150	141	111	111	111	
55	53	44	30	18	12	5'	160	164	160	112	115	112	82	92	82	
36	39	34	28	20	14	6'	126	132	126	89	97	89	68	73	68	
27	30	28	23	19	15	7'	106	111	106	75	84	75	59	62	59	
22	25	22	19	17	15	8'	89	95	89	65	72	65	51	52	51	
17	19	18	16	14	13	9'	70	75	70	52	60	52	41	42	41	
11	14	13	12	11	9	10'	50	54	50	40	44	40	30	34	30	

LUMINAIRES SPACED 3' FROM WALL

Catalog Number: L8 90LM 35K 120 G4 80CRI ZT; L8 WS CD Spread: Single Wall Test #: PR07171795

Single Unit							Lamp	Multiple Units On 3' Centers*			Multiple Units On 4' Centers*			Multiple Units On 6' Centers*		
Lateral Distance From Fixture 3' From Wall							BXRC-35E10K0-D-73-SE	Spaced 3' From Wall			Spaced 3' From Wall			Spaced 3' From Wall		
0'	1'	2'	3'	4'	5'	Distance From Ceiling	CL	CL	CL	CL	CL	CL	CL	CL	CL	
48	42	26	16	10	8	1'	78	74	78	64	55	64	52	25	52	
101	89	57	32	18	12	2'	165	163	165	131	119	131	107	57	107	
81	75	55	35	21	14	3'	152	154	152	118	115	118	89	62	89	
69	63	46	30	21	15	4'	130	129	130	103	97	103	77	54	77	
56	53	43	30	20	15	5'	115	117	115	88	92	88	64	54	64	
44	42	37	30	22	16	6'	101	101	101	79	81	79	53	54	53	
34	33	30	26	22	17	7'	88	91	88	69	71	69	45	48	45	
25	27	25	22	19	17	8'	74	81	74	58	64	58	39	40	39	
19	21	20	18	16	15	9'	60	68	60	47	53	47	32	33	32	
14	15	15	12	13	12	10'	48	51	48	37	41	37	26	26	26	

LUMINAIRES SPACED 4' FROM WALL

Catalog Number: L8 90LM 35K 120 G4 80CRI ZT; L8 WS CD Spread: Single Wall Test #: PR07171795

Single Unit							Lamp	Multiple Units On 3' Centers*			Multiple Units On 4' Centers*			Multiple Units On 6' Centers*		
Lateral Distance From Fixture 4' From Wall							BXRC-35E10K0-D-73-SE	Spaced 4' From Wall			Spaced 4' From Wall			Spaced 4' From Wall		
0'	1'	2'	3'	4'	5'	Distance From Ceiling	CL	CL	CL	CL	CL	CL	CL	CL	CL	
25	23	17	13	10	8	1'	47	48	47	38	37	38	30	23	30	
57	51	38	26	19	14	2'	110	110	110	86	83	86	66	50	66	
64	60	48	35	24	17	3'	133	138	133	105	104	105	76	66	76	
51	48	41	31	23	18	4'	117	119	117	91	92	91	65	60	65	
46	43	35	28	22	17	5'	103	105	103	82	80	82	60	52	60	
41	39	34	27	21	17	6'	98	99	98	76	78	76	55	51	55	
35	33	30	26	21	17	7'	89	92	89	71	71	71	48	48	48	
29	28	26	22	20	18	8'	80	84	80	64	65	64	44	44	44	
23	22	20	19	17	16	9'	67	71	67	53	55	53	38	36	38	
16	16	16	14	14	13	10'	53	54	53	41	43	41	29	31	29	

*Based on minimum of five luminaires. Reflectances: 80, 50, 20. Values are rounded to nearest whole footcandle.

Fixtures tested to IES recommended standard for solid state lighting per LM-79-08. Photometric performance on a single unit represents a baseline of performance for the fixture. Results may vary in the field.

CONTROLS

EXAMPLE

Group Fixture Control*

*Application diagram applies for fixtures with eldoLED drivers only.

nPS 80 EZ Dimming/Control Pack (qty: 2 required)

nPODM 2P DX Dual On/Off/Dim Push-Button WallPod

nCM ADCX Daylight Sensor with Automatic Dimming Control

nCM PDT 9 Dual Technology Occupancy Sensor

Description: This design provides a dual on/off/dim wall station that enables manual control of the fixtures in Row A and Row B separately. Additionally, a daylight harvesting sensor is provided so the lights in Row B can be configured to dim automatically when daylight is available. An occupancy sensor turns off all lights when the space is vacant.

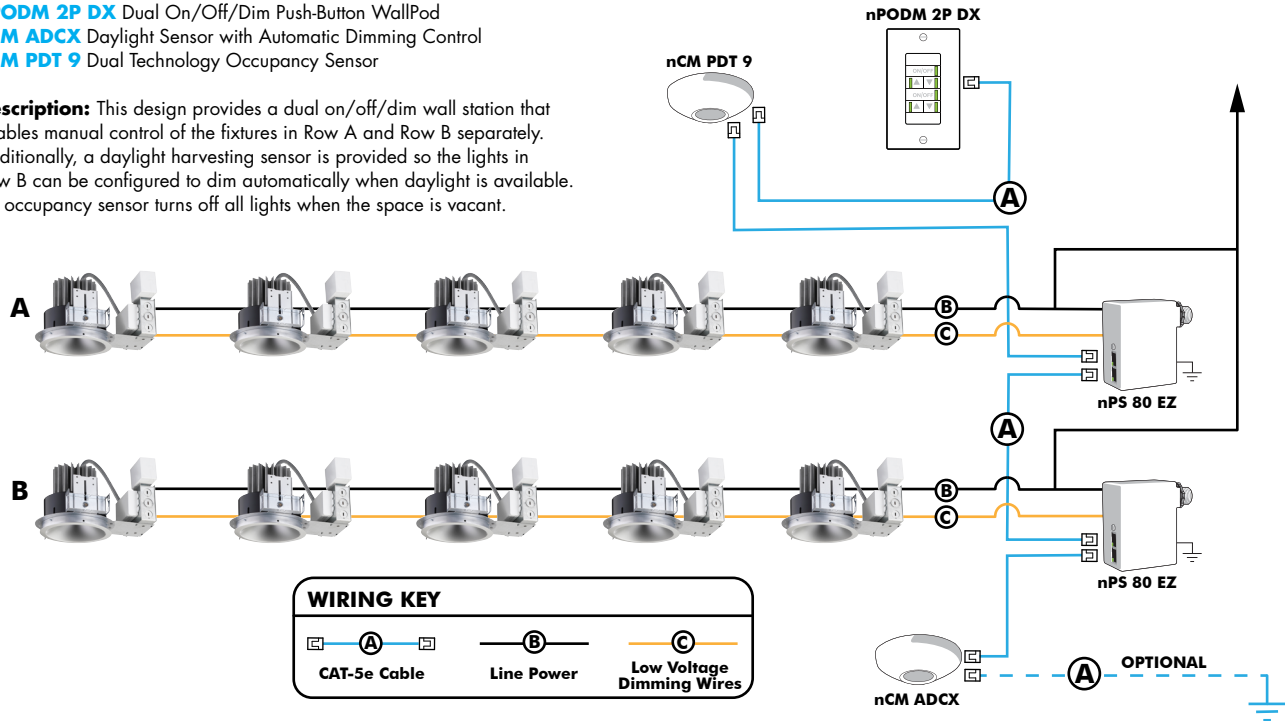

Choose Wall Controls

nLight offers multiple styles of wall controls - each with varying features and user experience.



Push-Button Wallpod
Traditional tactile buttons and LED user feedback



Graphic Wallpod
Full color touch screen provides a sophisticated look and feel

nLight® Wired Controls Accessories:

Order as separate catalog number. Visit www.acuitybrands.com/products/controls/nlight for complete listing of nLight controls.			
WallPod Stations	Model number	Occupancy sensors	Model Number
On/Off	nPODM (Color)	Small motion 360°, ceiling (PIR/dual Tech)	nCM 9 / nCM PDT 9
On/Off & Raise/Lower	nPOD DX (Color)	Large motion 360°, ceiling (PIR/dual tech)	nCM 10 / nCM PDT 10
Graphic Touchscreen	nPOD GFX (Color)	Wide View (PIR/dual tech)	nWV 16 / nWV PDT 16
Photocell controls	Model Number	Wall Switch w/ Raise/Lower (PIR/dual tech)	nWSX LV DX / nWSX PDT LV DX
Dimming	nCM ADCX	Cat-5 cables (plenum rated)	Model Number
		10', CAT5 10FT	CATS 10FT J1
		15, CAT5 15FT	CATS 15FT J1



Capable Luminaire

This item is an A+ capable luminaire, which has been designed and tested to provide consistent color appearance and out-of-the-box control compatibility with simple commissioning.

- All configurations of this luminaire meet the Acuity Brand's specification for chromatic consistency.
- This luminaire is part of an A+ Certified solution for nLight control networks when ordered with drivers marked by a Shaded background*
- This Luminaire is part of an A+ Certified solution for nLight control networks, providing advanced control functionality at the luminaire level, when selection includes driver and control options marked by a shaded background*

To learn more about A+, visit www.acuitybrands.com/aplus.

*See ordering tree for details

nLight® AIR Control Accessories:

Order as separate catalog number. Visit www.acuitybrands.com/products/controls/nlightair.

Wall switches	Model number
On/Off single pole	rPODB [color]
On/Off two pole	rPODB 2P [color]
On/Off & raise/lower single pole	rPODB DX [color]
On/Off & raise/lower two pole	rPODB 2P DX [color]
On/Off & raise/lower single pole	rPODBZ DX WH ¹

Notes

1 Can only be ordered with the RES7Z zone control sensor version.

nLight AIR

nLight AIR is the ideal solution for retrofit or new construction spaces where adding communication is cost prohibitive. The integrated nLight AIR rPP20 Power Pack is part of each Indy L-Series Luminaire. These individually addressable controls offer the ultimate in flexibility during initial setup and for space repurposing.



Simple as 1,2,3

1. Install the nLight® AIR fixtures with embedded smart sensor
2. Install the wireless battery-powered wall switch
3. With CLAIRITY app, pair the fixtures with the wall switch and if desired, customize the sensor settings for the desired outcome

