

**Vulite®**

# 4" IC LOW VOLTAGE NEW CONSTRUCTION HOUSING

LOW VOLTAGE LAMPS

**V4ICLV W**

Project: \_\_\_\_\_

Fixture Type: \_\_\_\_\_

Location: \_\_\_\_\_

Contact/Phone: \_\_\_\_\_

## PRODUCT DESCRIPTION

IC Air-Loc® Housing • Air-Loc rated with all 4" trims and complies with the Washington State and IECC Energy Codes • Can be completely covered with insulation • Double wall construction • Energy efficient, sealed inner housing does not require separate gasket • Air-Loc housing stops infiltration and exfiltration of air, reducing heating and cooling costs.

## PRODUCT SPECIFICATIONS

**Lamp** One 12V, 50W MR16 lamp.

**Socket** Ceramic bi-pin socket with aluminum heat shield.

**Trims** Trim selection shown on reverse.

**Transformer** 120V to 12V 50VA thermally protected magnetic transformer mounted inside outer housing.

**Dimming** May be dimmed using dimmers specifically designed for low voltage magnetic transformers; consult factory or dimmer manufacturer for additional information.

**Labels** UL/cUL listed for through-branch wiring, damp locations and IP • Product thermally protected against improper use of lamps • UL/cUL listed • Trim V4041 is wet location approved for covered ceiling applications.

**Testing** All reports are based on published industry procedures; field performance may differ from laboratory performance.

Specifications subject to change without notice.

## INSTALLATION

**Bar Hangers** Telescoping bar hangers with captive nail allow for quick placement of housing anywhere within 24" O.C. joists • Can be installed in suspended ceiling grid using T-bar clip accessory • Bars scored in two locations for fast, clean breaking, allowing housing installation in tight applications • Edge-mounted for extra strength and captive to mounting frame • May be installed either parallel or perpendicular to junction box • Locking set screw locks fixture in position • Alternate mounting holes included.

**Junction Box** Pre-wired junction box provided with (6) 1/2" and (1) 3/4" knockouts, (4) Non-metallic sheathed cable connectors and ground wire, U.L. listed/CSA certified for through-branch wiring, maximum 6 No. 12 AWG 90° C branch circuit conductors (3 in, 3 out) • Junction box provided with removable access plates • Knockouts equipped with pryout slots.

**Mounting Frame** 22-gauge die-formed galvanized steel mounting frame • Rough-in section (junction box, mounting frame, housing and bar hangers) fully assembled for ease of installation.

**Housing** Air-Loc IC housing, .032" aluminum • Access door for junction box accessibility • Housing is vertically adjustable to accommodate up to a 1" ceiling thickness.

## DIMENSIONS

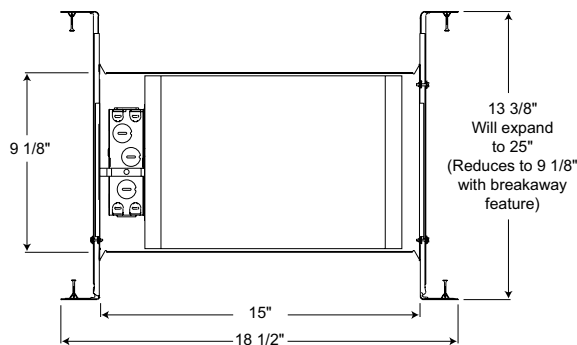

4 1/2" CEILING CUTOUT

## ACCESSORIES

Catalog No.	Description
G2405	T-Bar Clips (Set of 4)

To order, specify catalog number







## PRODUCT CODES

Catalog No.	Input Voltage	Lamp Rating (max.)
V4ICLV W	120V	12V 50W MR16

# 4" IC LOW VOLTAGE NEW CONSTRUCTION HOUSING

LOW VOLTAGE LAMPS

**V4ICLV W****TRIMS/LAMPS**

	<b>Cat. No.</b>	<b>Description</b>	<b>Max. Lamp Rating</b>
	<b>V4044 WWH</b> <b>V4044 BWH</b>	White Baffle with Regressed Gimbal Ring Black Baffle with Regressed Gimbal Ring	50W MR16
	<b>V4047 CWH</b>	Clear Cone with Regressed Gimbal Ring	50W MR16
	<b>V4040 WH</b>	White Gimbal Ring	50W MR16
	<b>V4048 WH</b>	White Eyeball with Baffle	50W MR16
	<b>V4041 WH</b> ◆	Stippled Opal Lens Shower	50W MR16
			

Note: Lamps may be dimmed. Use dimmers specifically designed for low voltage magnetic transformers; consult factory or dimmer manufacturer for additional information.

Trim Size: 5" O.D.

Trim Finish: WH - White.

Note: In Canada when insulation is present, Type IC fixtures must be used.

◆ UL/cUL Listed for use in wet location.

**AIR-LOC** Vulite IC housings meet IECC Energy Code requirements per ASTM E283.  
Air-Loc® rated trims are pre-gasketed for minimum air leakage with IC housings.