

JACK & JUNE

JJ-PLAYHOUSE
(PLAYHOUSE SET)

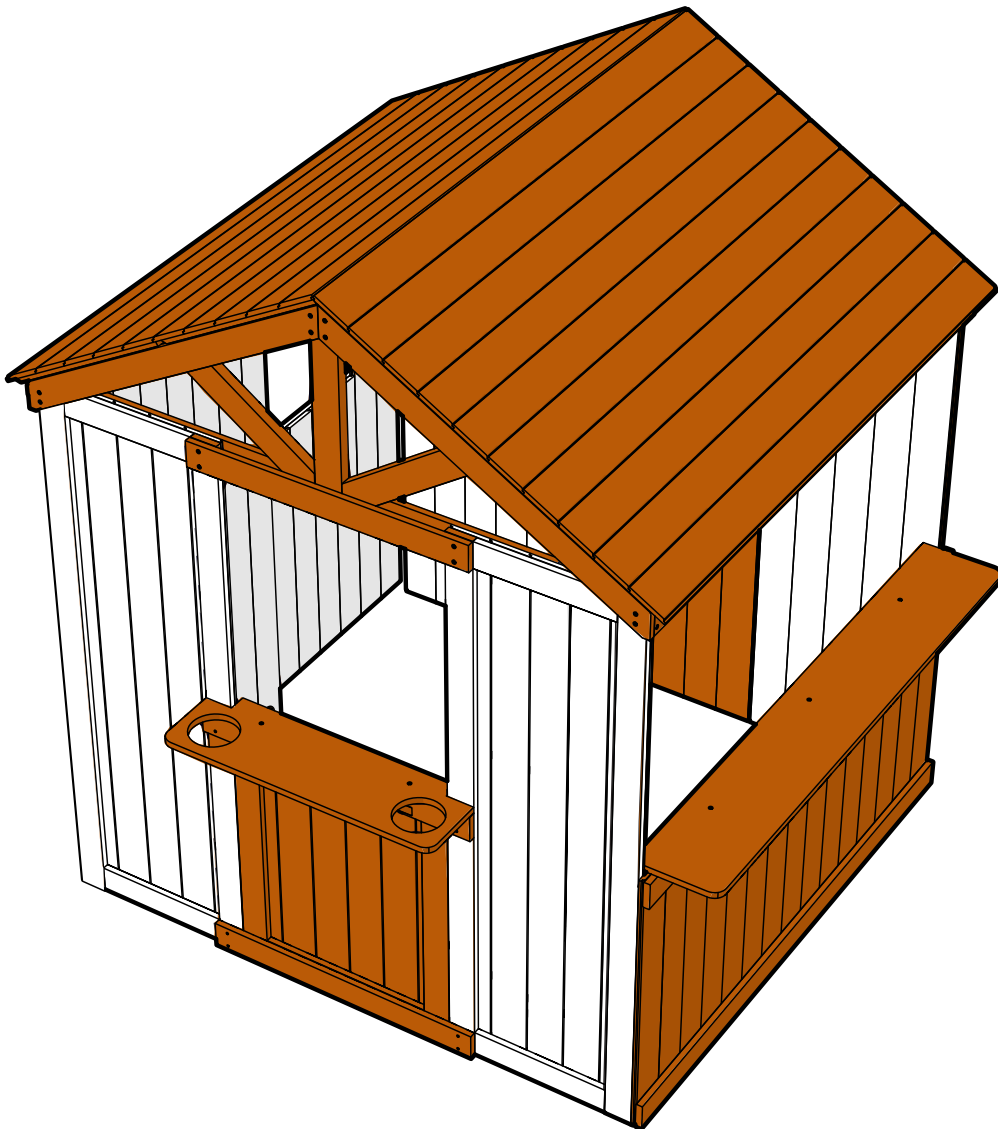

PARTS LIST (NOT ACTUAL SIZE)

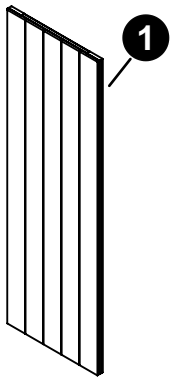

Side Panels
JJ-PH-SIDE-PANEL
QTY. 4

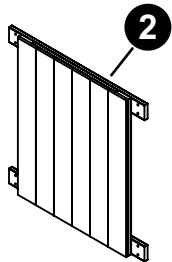

Side Panels Short
JJ-PH-SIDE-PANEL-SHORT
QTY. 2

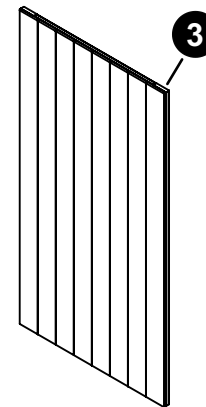

Front Panel
JJ-PH-FRONT-PANEL
QTY. 1

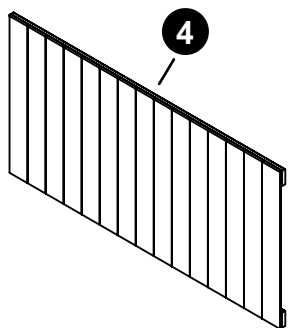

Back Panel
JJ-PH-BACK-PANEL
QTY. 1

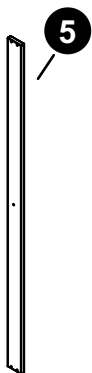

Panel Support 48 with 5 Holes
2W-7968-00
QTY. 2

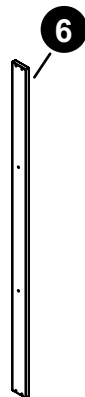

Panel Support 48 with 6 Holes
2W-7969-00
QTY. 2

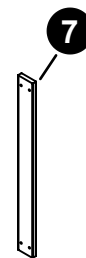

Panel Support 24 with Holes
2W-7958-00
QTY. 2



Corner Bracket
QTY. 26

PARTS LIST (NOT ACTUAL SIZE)

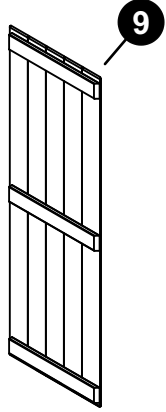

Roof Panel
JJ-PH-ROOF-PANEL
QTY. 4

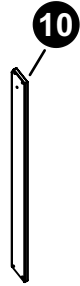

Rafter
2W-7970-00
QTY. 4

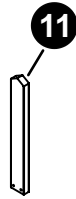

Middle Rafter Support
2W-7971-00
QTY. 2

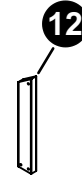

Side Rafter Support
2W-7972-00
QTY. 4

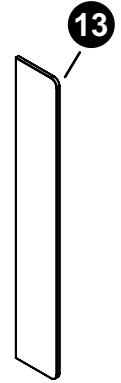

Counter
2W-7973-00
QTY. 1

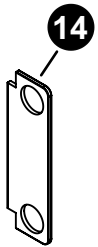

SHORT COUNTER
2W-7974-00
QTY. 2



6" SAFETY HANDLE
ST-HANDLE-006 DSP
QTY. 1

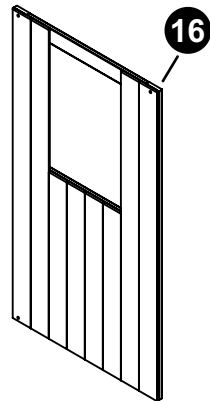

Door Panel
JJ-PH-DOOR-PANEL
QTY. 1

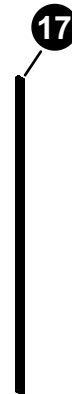

Door Rail
PG-AC-0056
QTY. 1

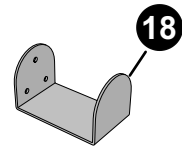

Door Safety Bracket
QTY. 1

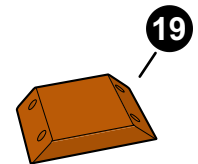

2X4 Counter Support
QTY. 8

HARDWARE IDENTIFIER (ACTUAL SIZE)



3/16" x 1.75" SOCKET BUTTON HEAD CAP SCREW
QTY. 2

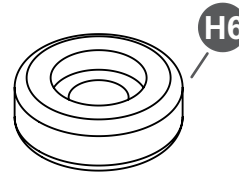

ROLLER
QTY. 2

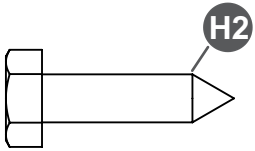

1/4 x 1" Hex Lag Screw
PG-HW-L008
QTY. 2

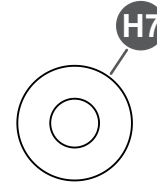

1/4" FLAT WASHER
PG-HW-W002
QTY. 4

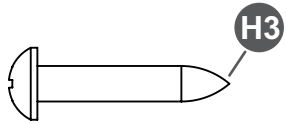

#10 X 1" ROUND HEAD SCREW
PG-HW-S001
QTY. 2

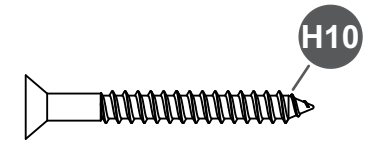

#8 x 1.5" Wood Screw
PG-HW-S003
QTY. 16

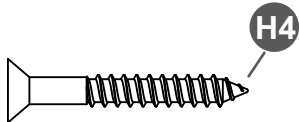

#8 X 1.25" PHILLIPS FLAT HEAD SCREW
PG-HW-S025
QTY. 99

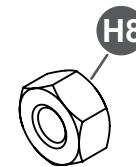

HEX NUT
QTY. 2

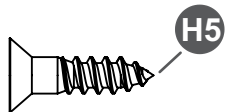

#10 X .75" PHILLIPS FLAT HEAD SCREW
PG-HW-S024
QTY. 107

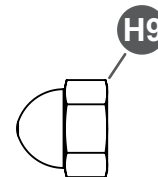

ACORN LOW CROWN NUT
QTY. 2

STEP 1 2X

HARDWARE NEEDED (ACTUAL SIZE)

16X

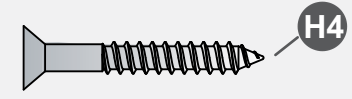

#8 x 1.25" Wood Screw
PG-HW-S025

NOTICE

Complete Step 1 to make a Side Assembly. Then, repeat Step to make a second side assembly.

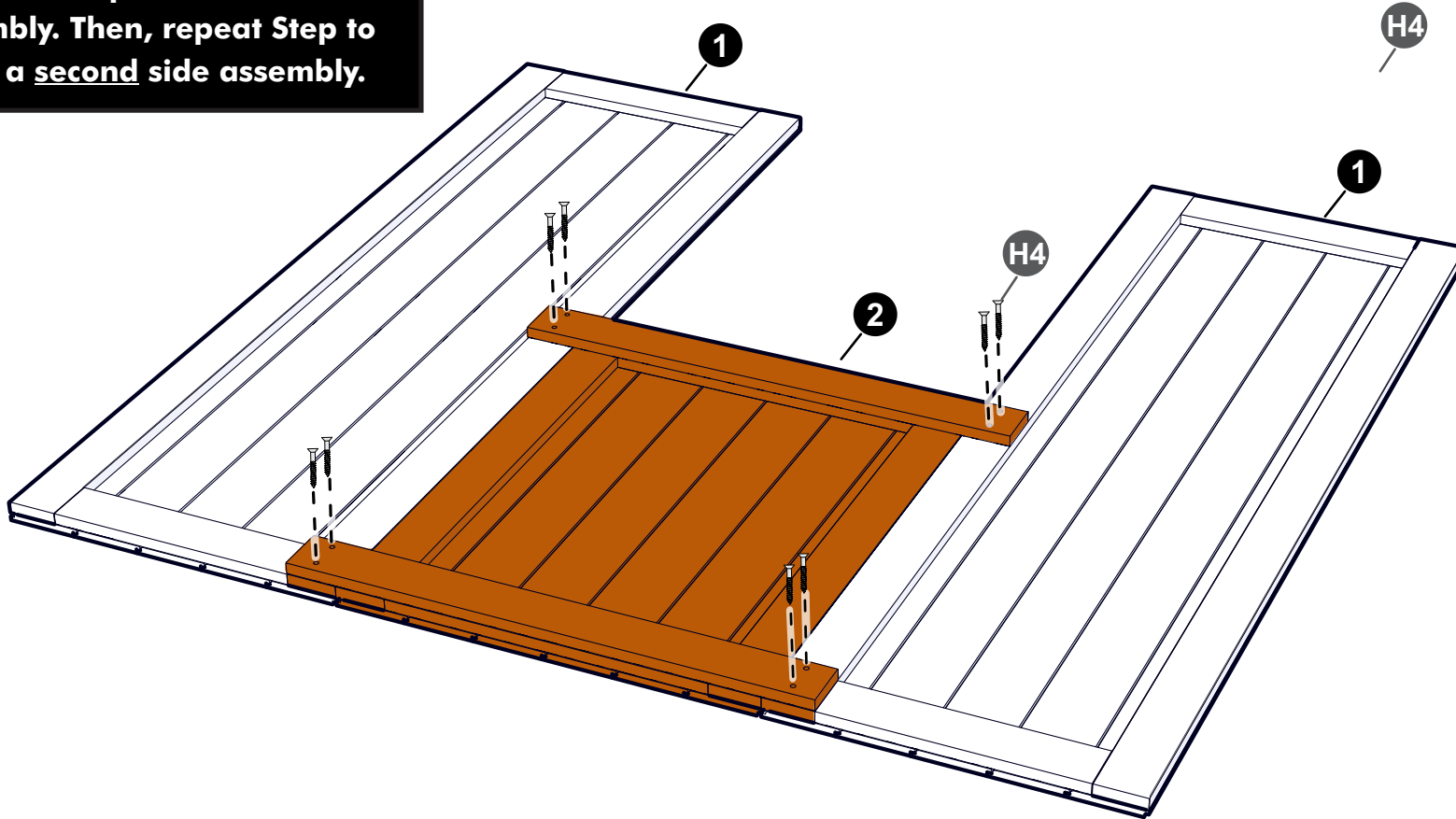

STEP 2 LEFT SIDE ASSEMBLY

NOTICE

Flip one Side Assembly and attach a (#6) Panel Support with 6 holes, making sure to center and equalize distance to each side to make a LEFT side assembly.

HARDWARE NEEDED (ACTUAL SIZE)

6X

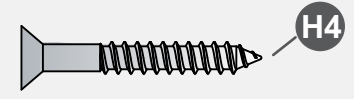

#8 x 1.25" Wood Screw
PG-HW-S025

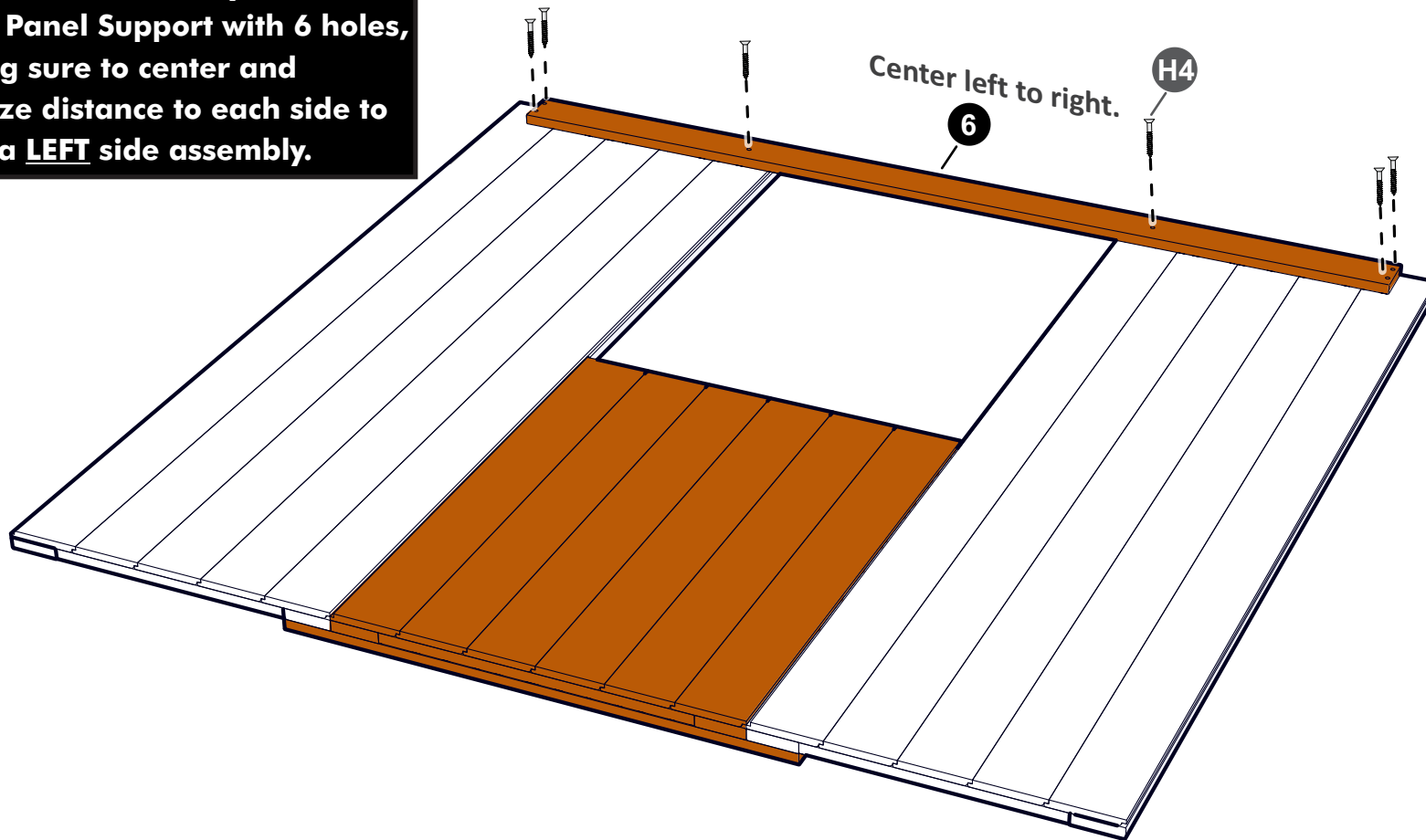

STEP 3 RIGHT SIDE ASSEMBLY

HARDWARE NEEDED (ACTUAL SIZE)

6X

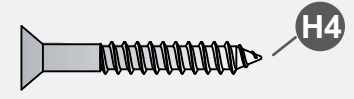

#8 x 1.25" Wood Screw
PG-HW-S025

NOTICE

Flip one Side Assembly and attach a (#5) use the dimensions shown to make a RIGHT side assembly.

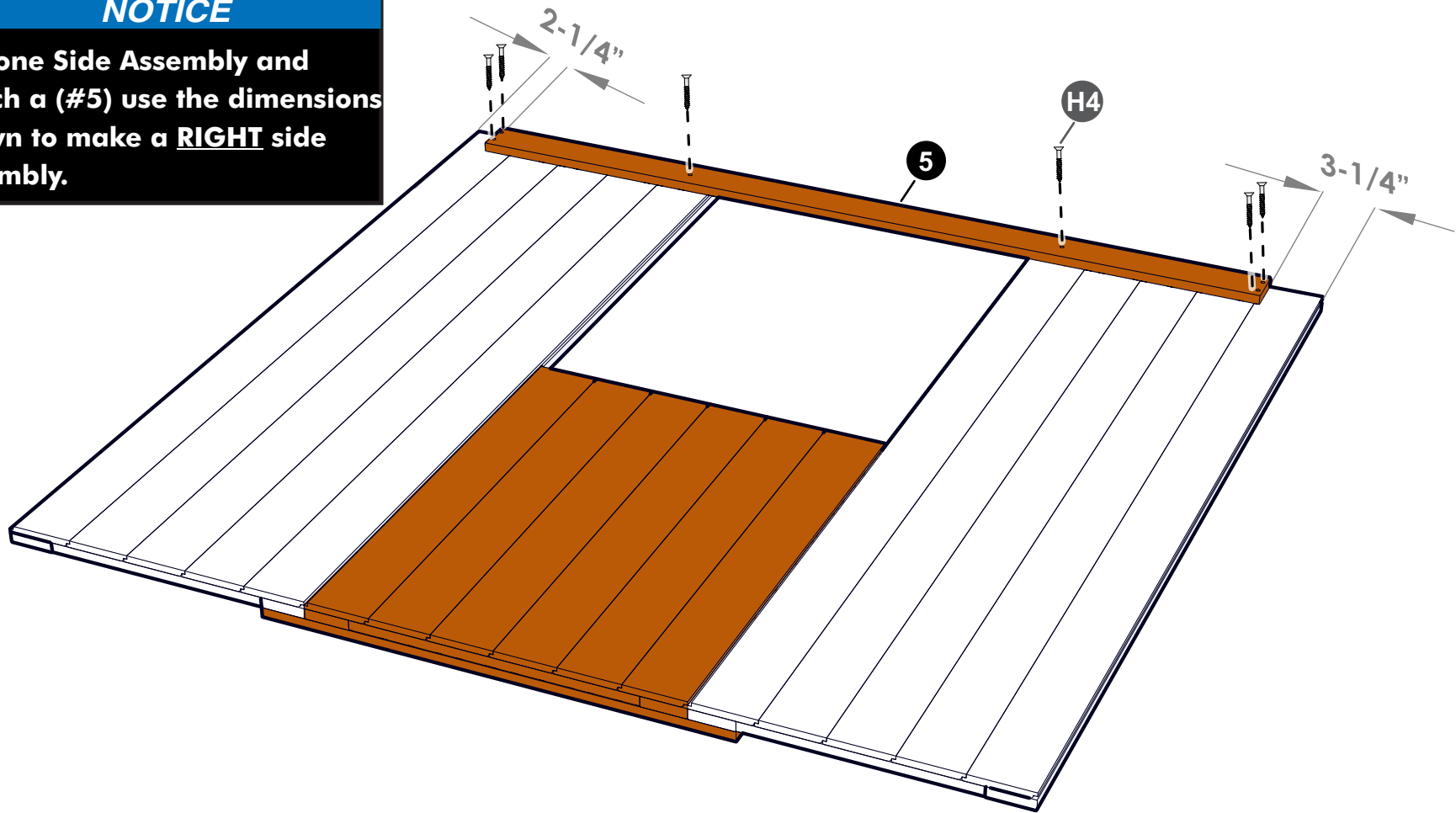

STEP 4

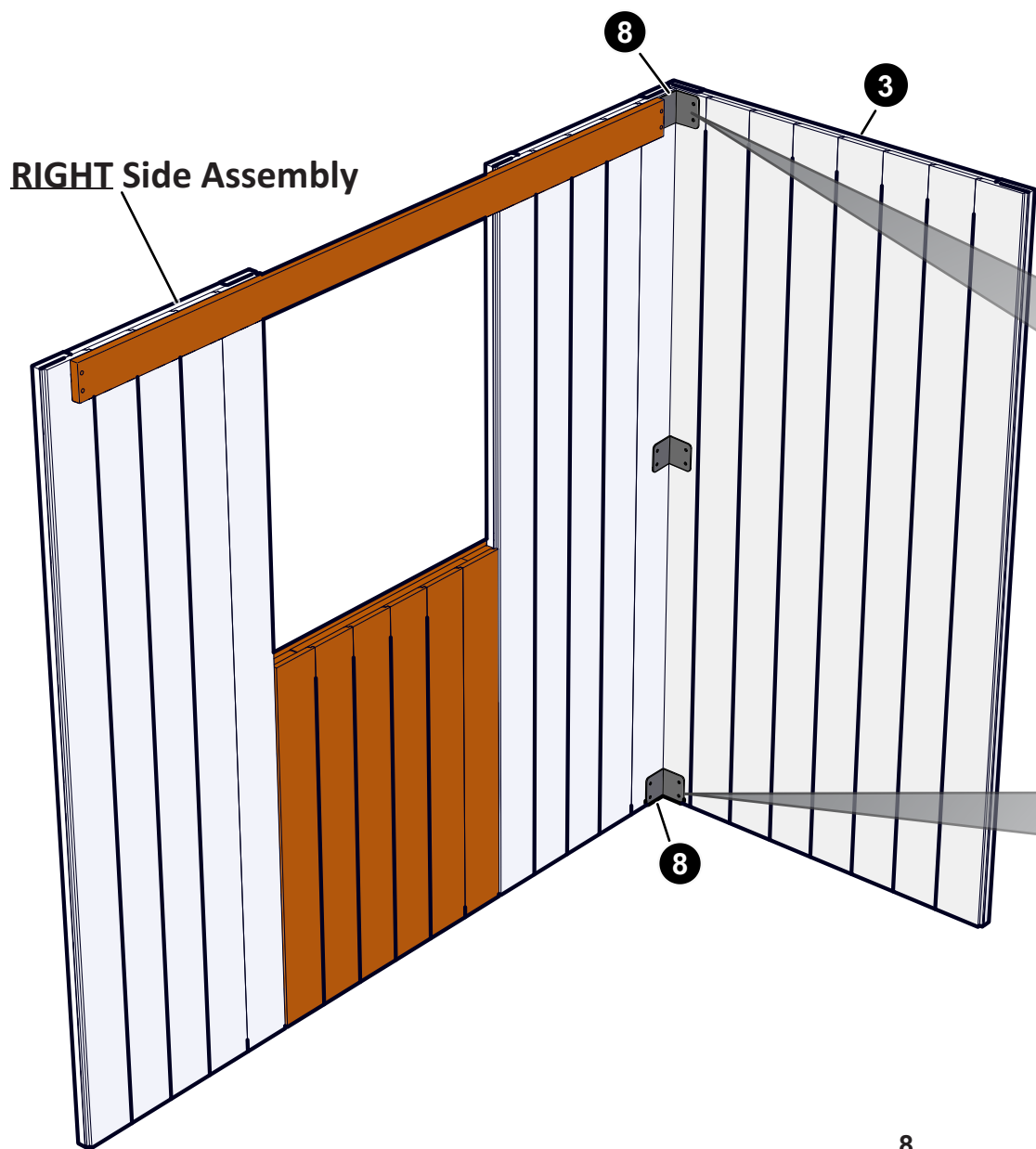

HARDWARE NEEDED (ACTUAL SIZE)

12X

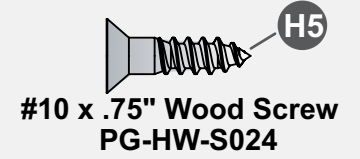

3X

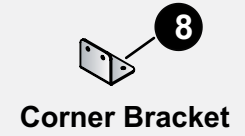

DETAIL A

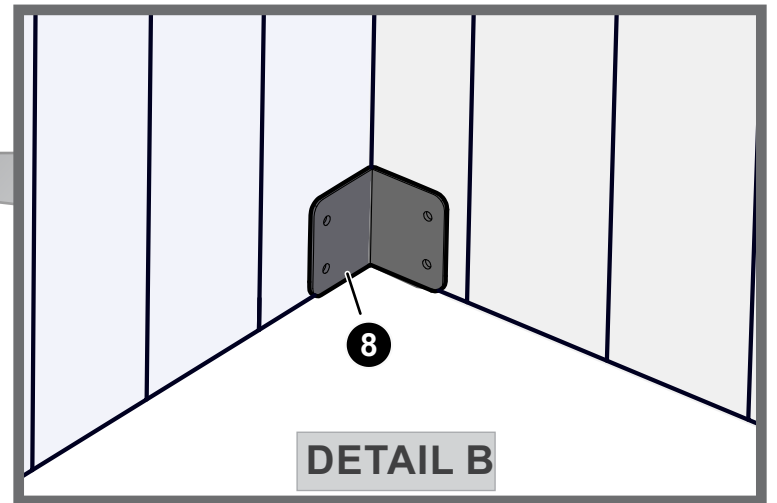
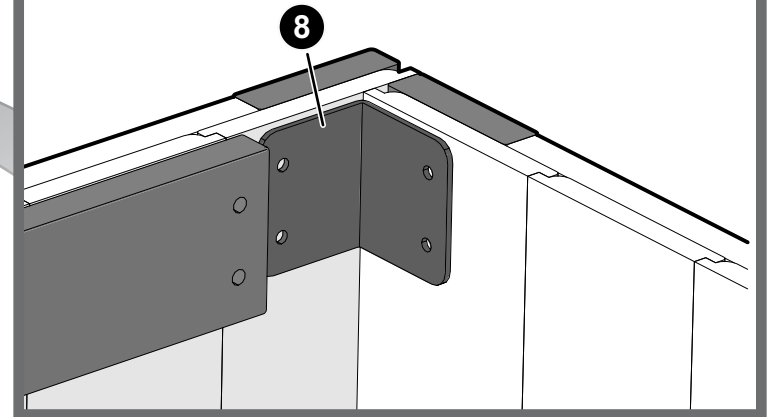

STEP 5

HARDWARE NEEDED (ACTUAL SIZE)

8X

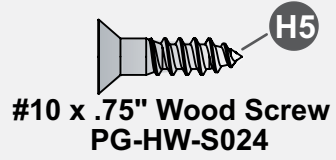

2X

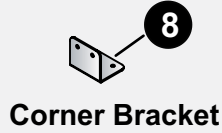

RIGHT Side Assembly

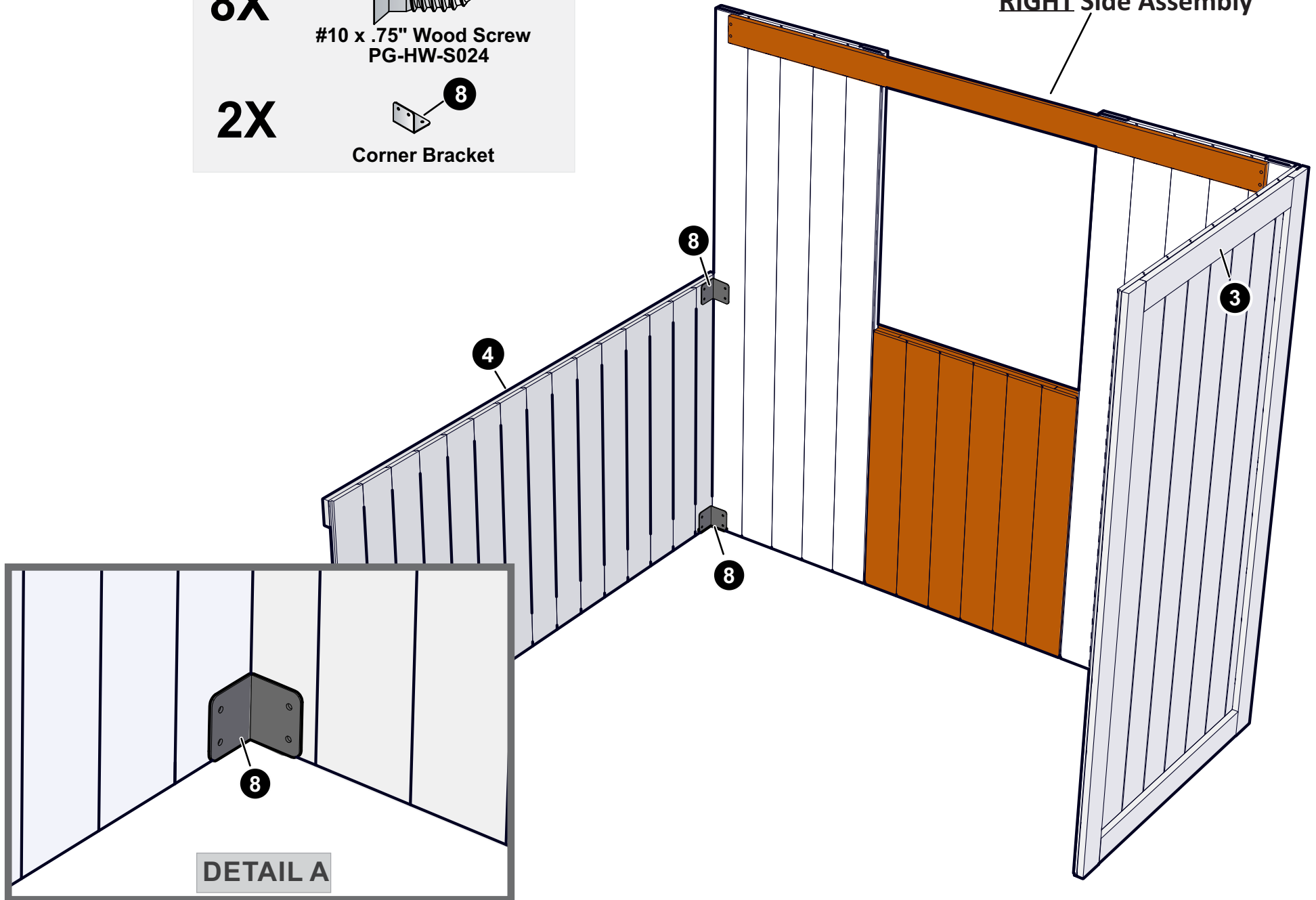

DETAIL A

STEP 6

HARDWARE NEEDED (ACTUAL SIZE)

4X



8X



2X

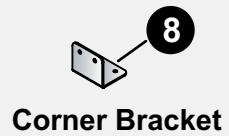

LEFT Side Assembly

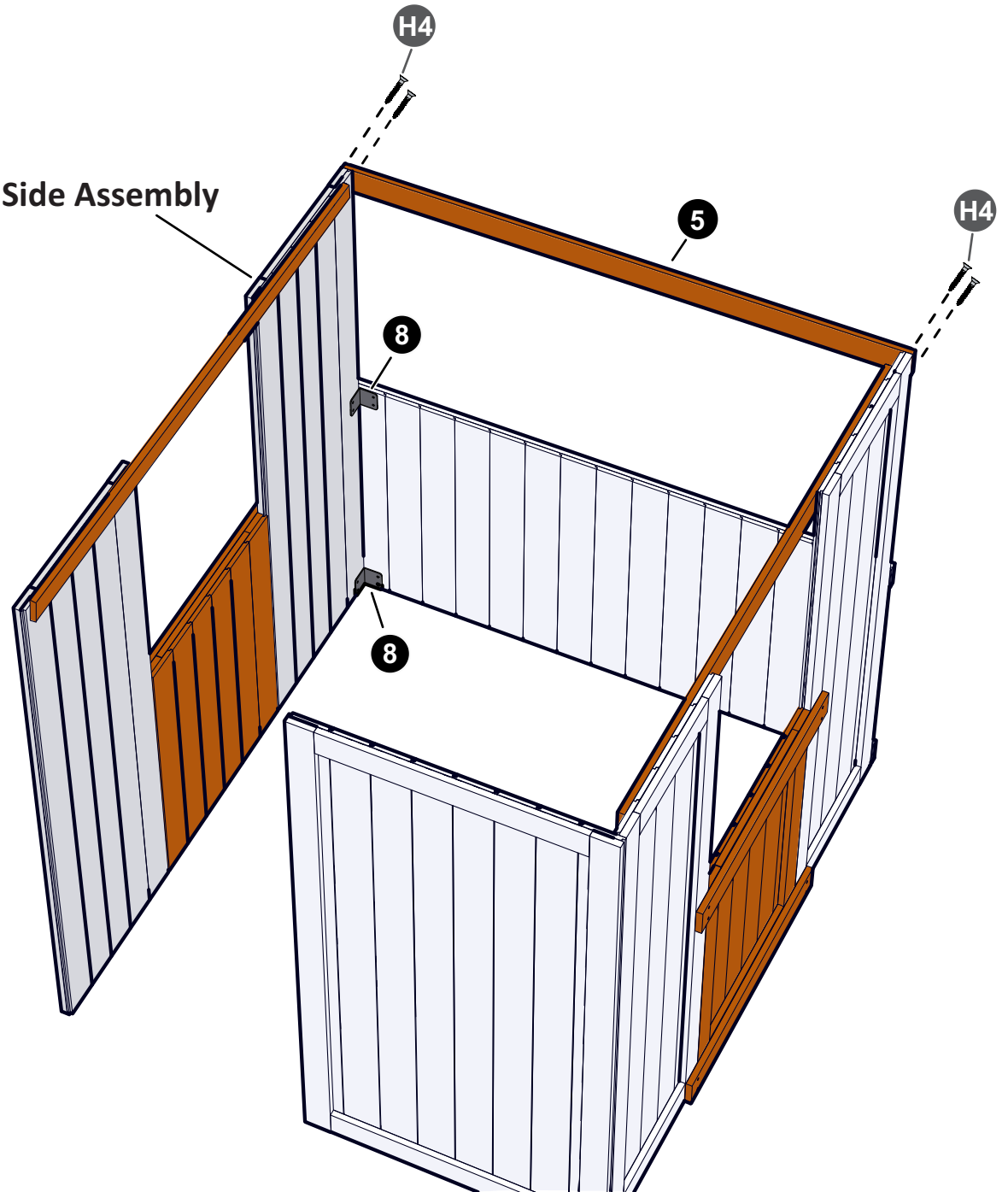

STEP 7

HARDWARE NEEDED (ACTUAL SIZE)

5X



#8 x 1.25" Wood Screw
PG-HW-S025

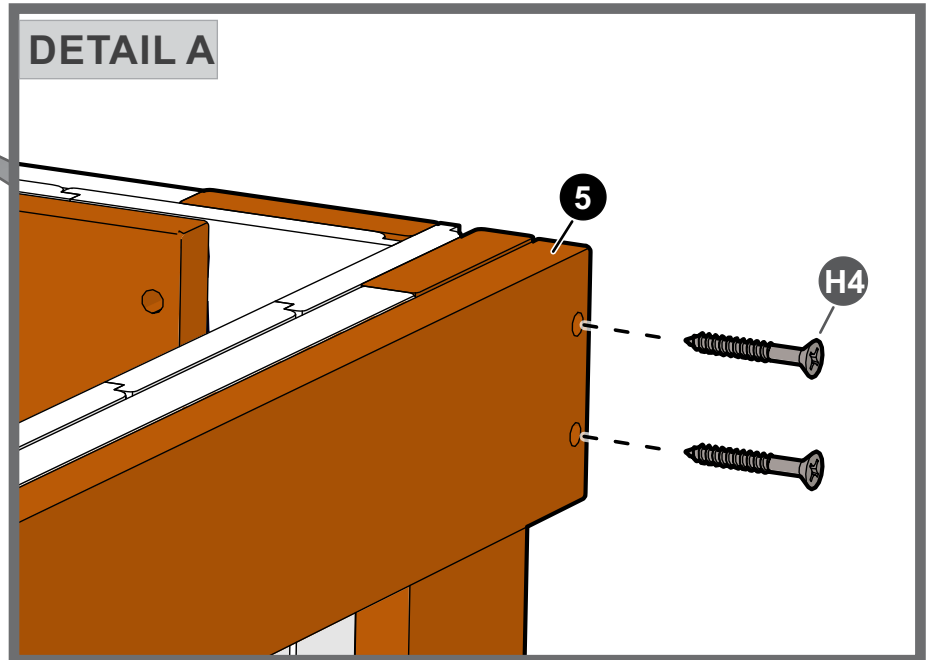
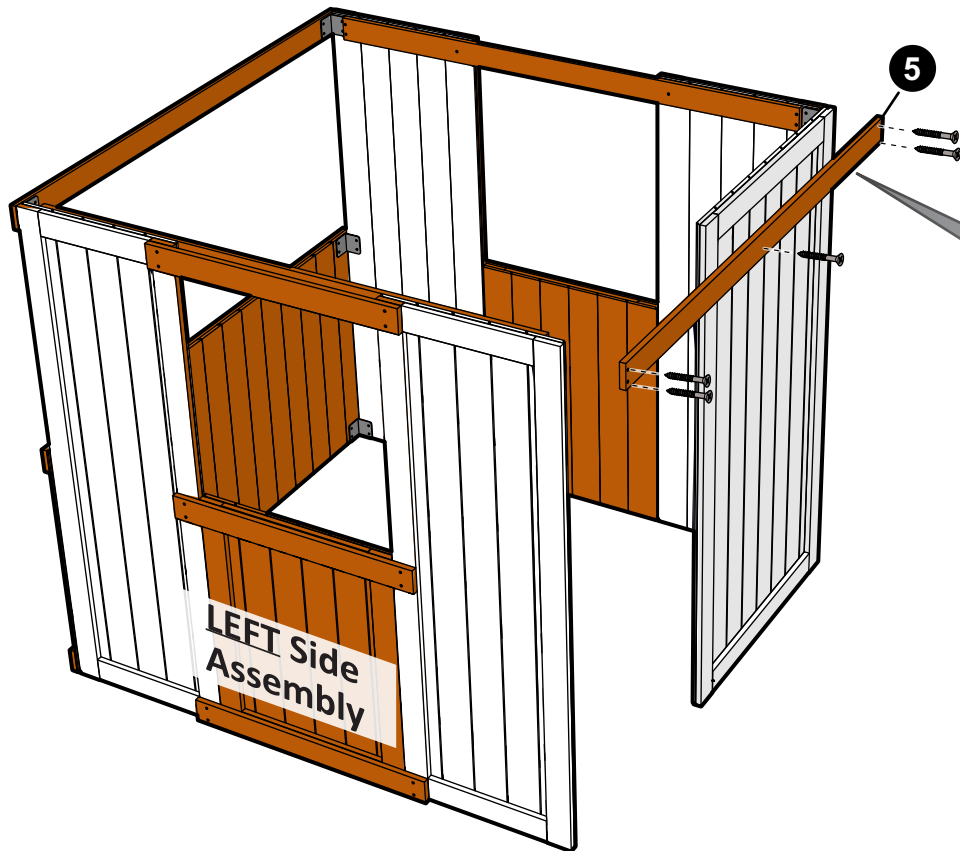

STEP 8

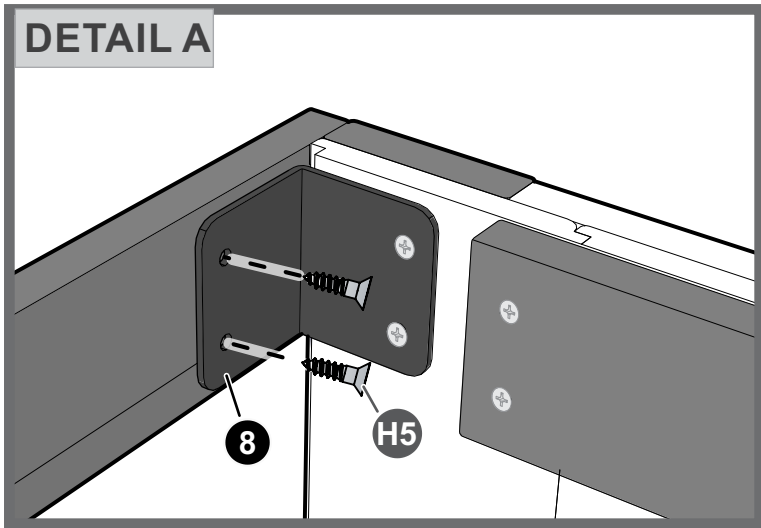

LEFT Side Assembly

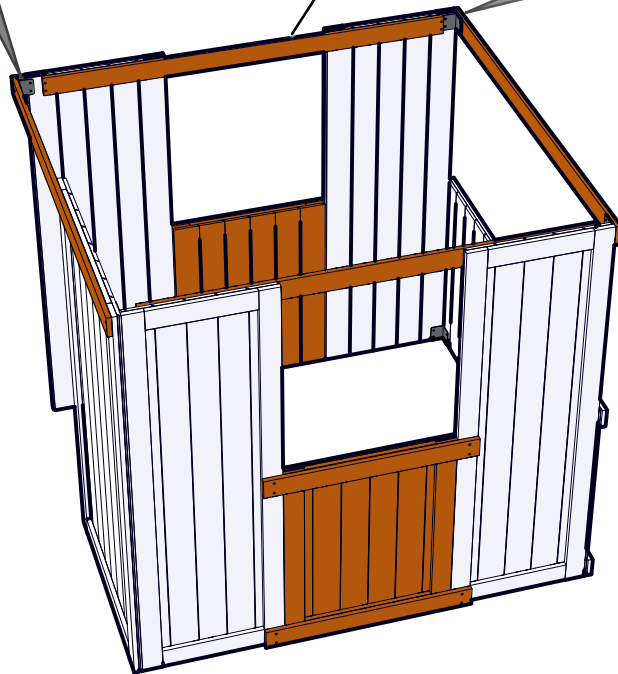

HARDWARE NEEDED (ACTUAL SIZE)

8X



2X

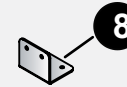

Corner Bracket

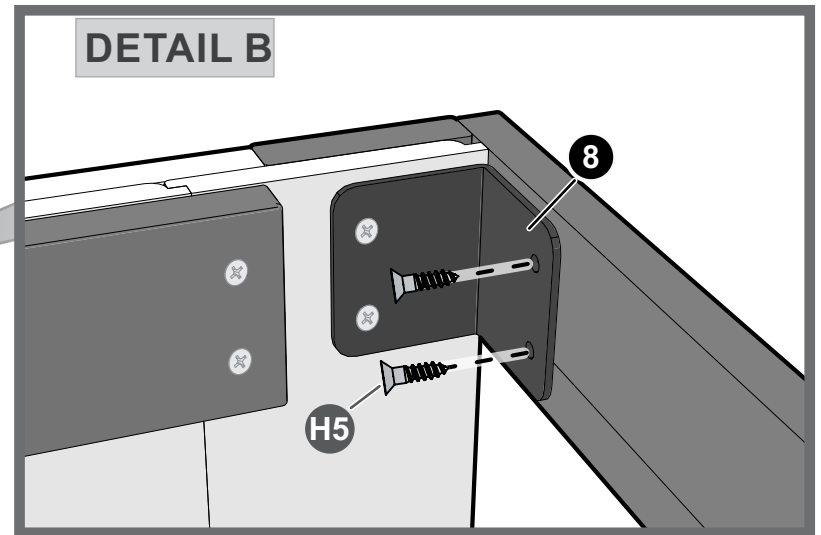

STEP 9

NOTICE

Attach Middle Rafter Support (#11) about a 1/4" above the edge of (#5) as shown.

HARDWARE NEEDED (ACTUAL SIZE)

4X

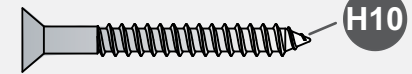

#8 x 1.5" Wood Screw

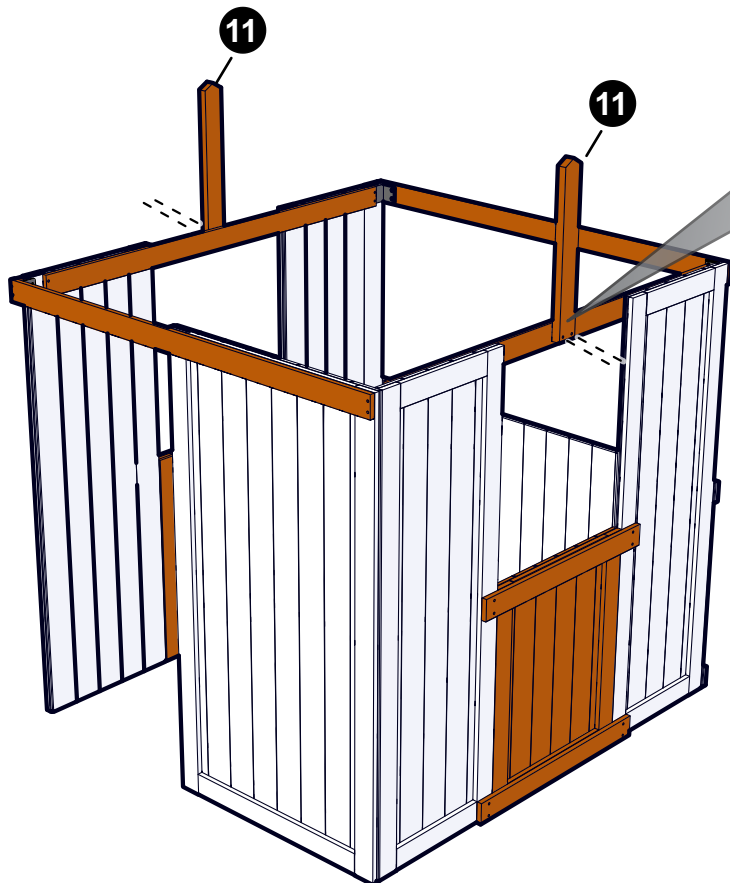

DETAIL A

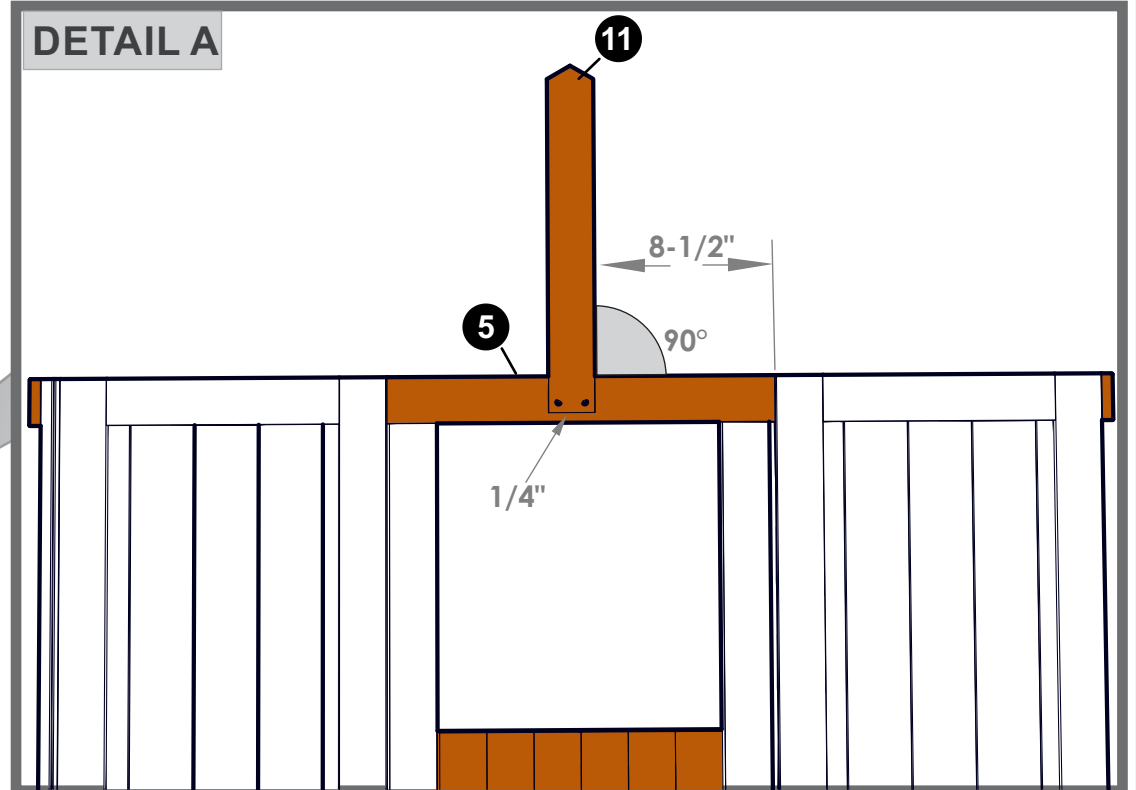

STEP 10

HARDWARE NEEDED (ACTUAL SIZE)

16X

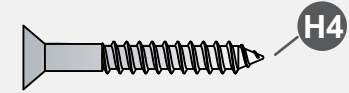

#8 x 1.25" Wood Screw
PG-HW-S025

NOTICE

Make sure top edge of corner is flush with top of panel supports.

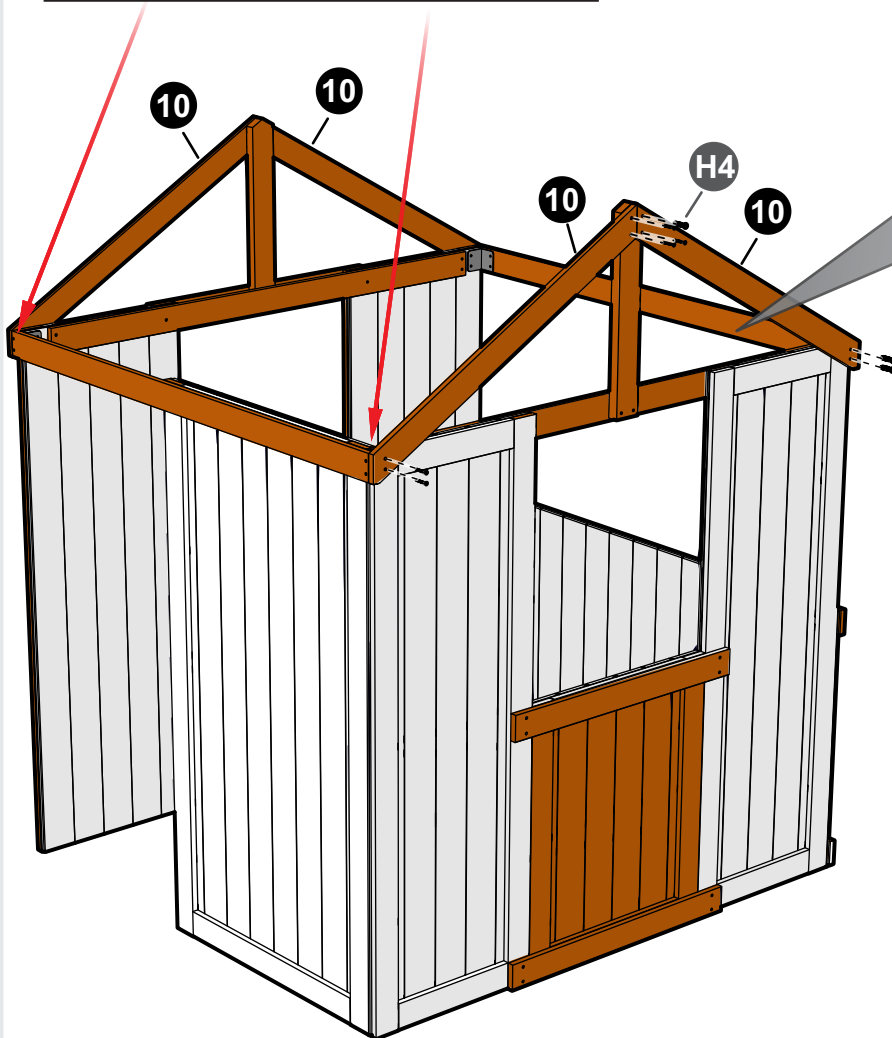

DETAIL A

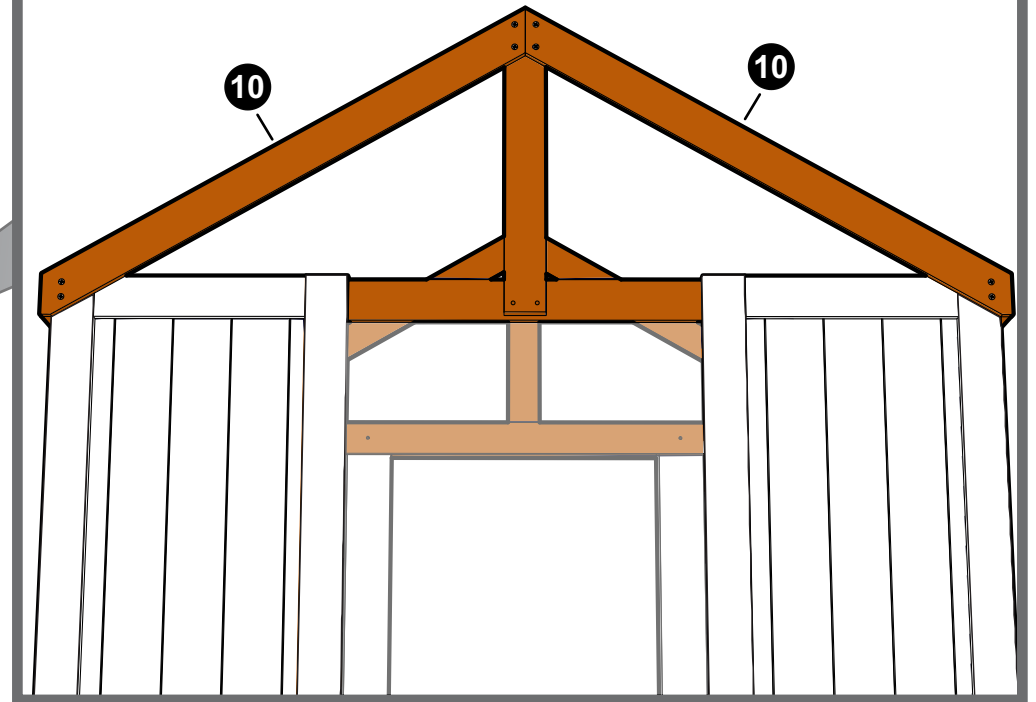

STEP 11

HARDWARE NEEDED (ACTUAL SIZE)

12X



#8 x 1.5" Wood Screw

HARDWARE FOR DETAIL A.

HARDWARE NEEDED (ACTUAL SIZE)

8X

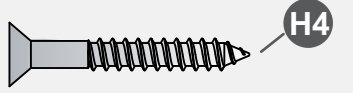

#8 x 1.25" Wood Screw
PG-HW-S025

HARDWARE FOR DETAIL B.

NOTICE

Install (#12) as shown in Detail A with H10 screws. Repeat for the other side.

NOTICE

Install (#7) as shown in Detail B with H4 screws. Repeat for the other side.

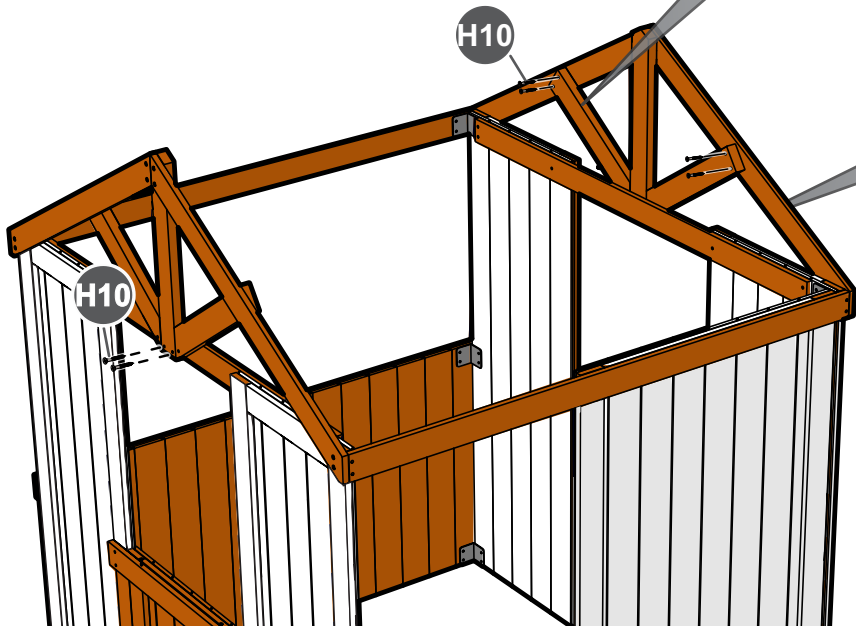
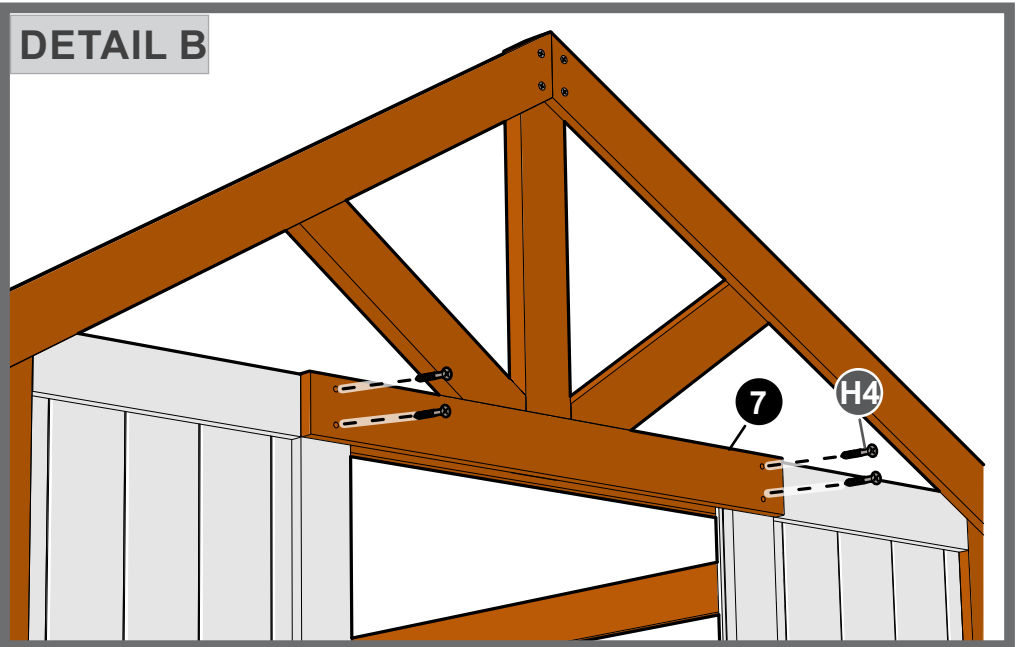
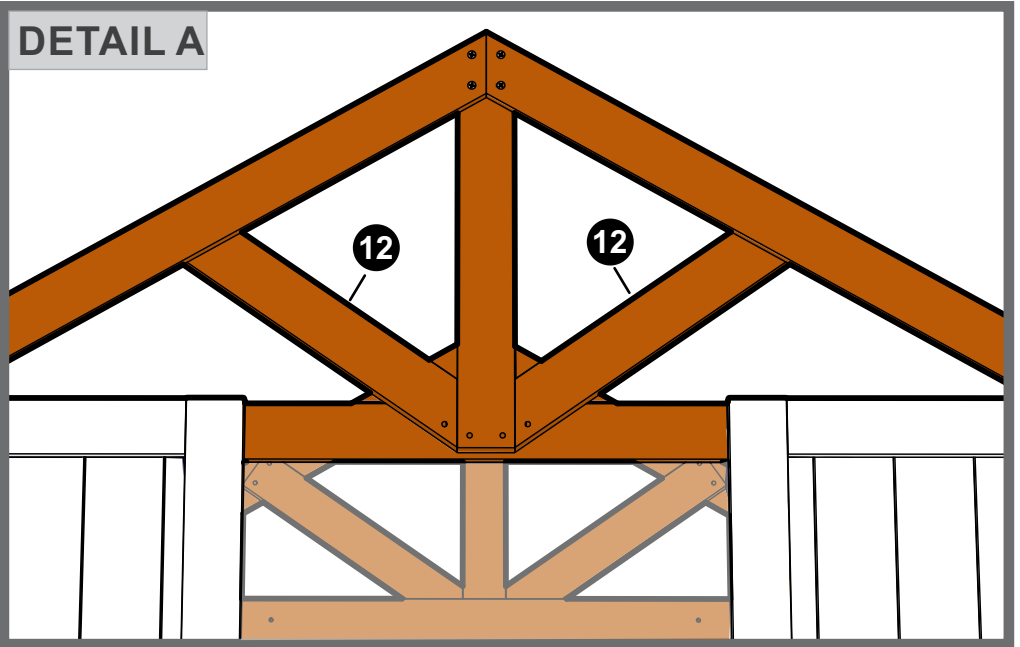

STEP 12

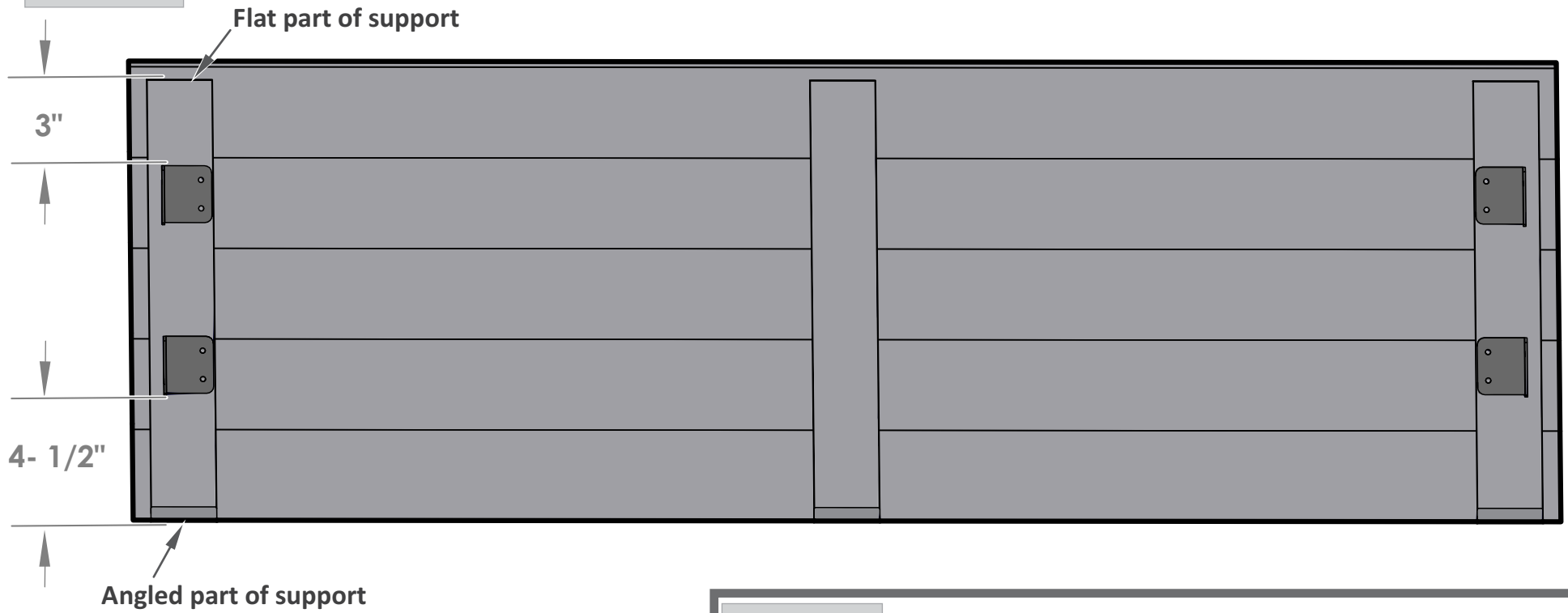

HARDWARE NEEDED (ACTUAL SIZE)

8X

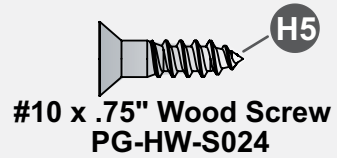

4X

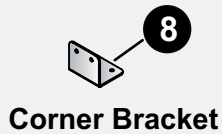

Repeat step **4X**

DETAIL A

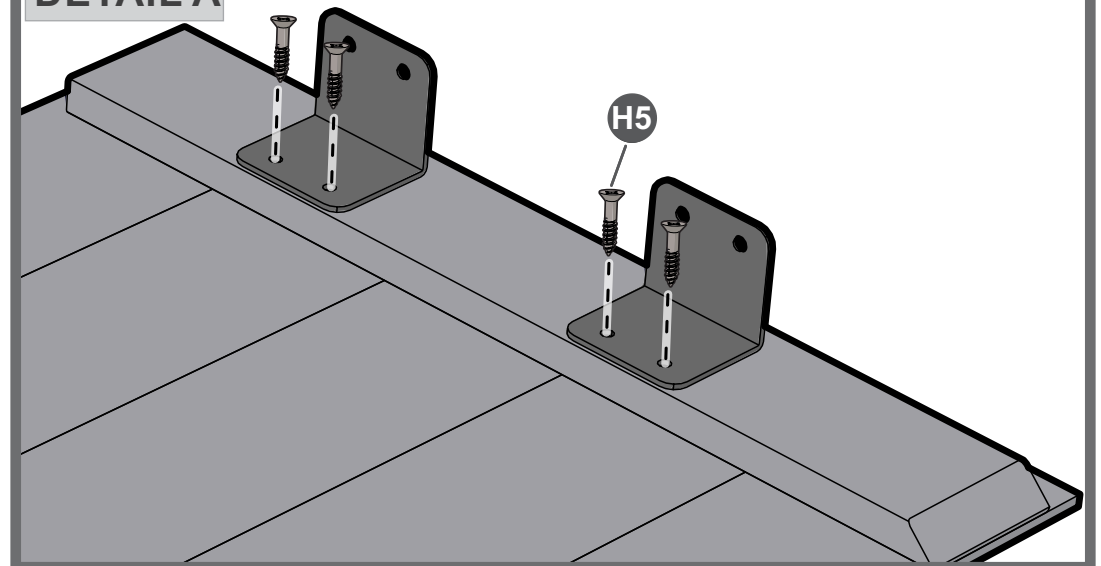

STEP 13

HARDWARE NEEDED (ACTUAL SIZE)

32X

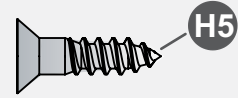

#10 x .75" Wood Screw
PG-HW-S024

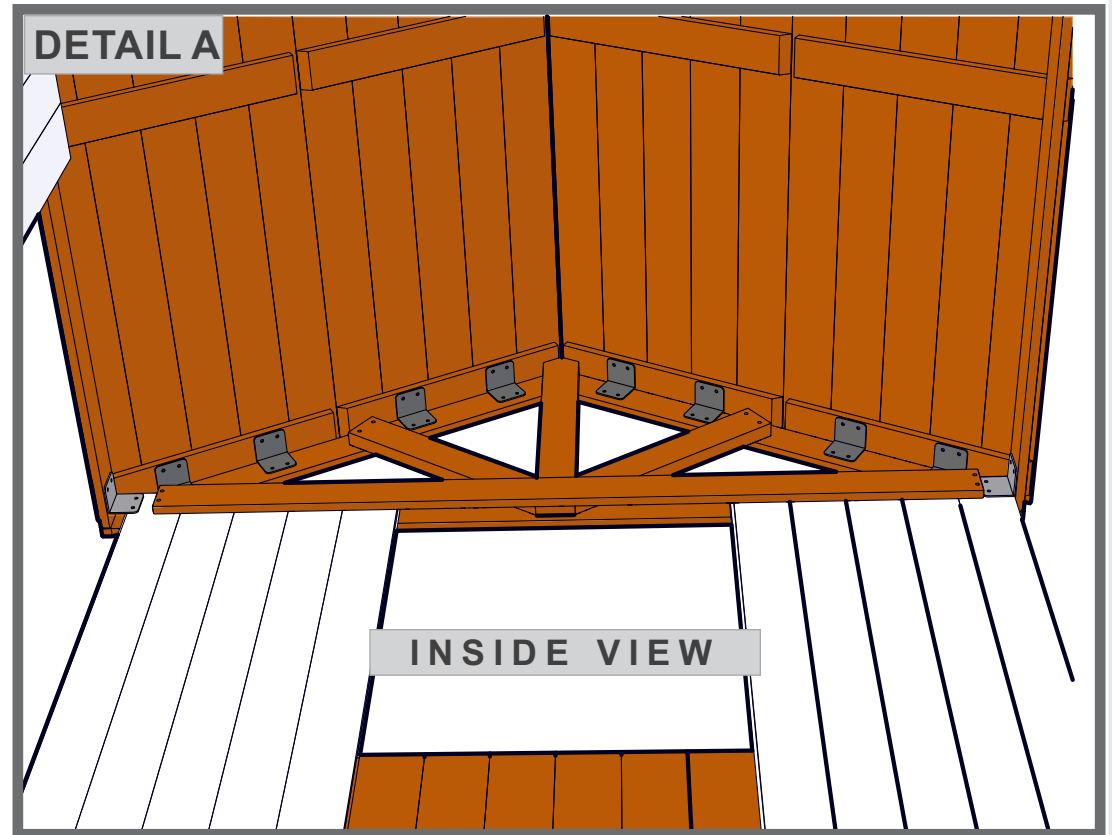
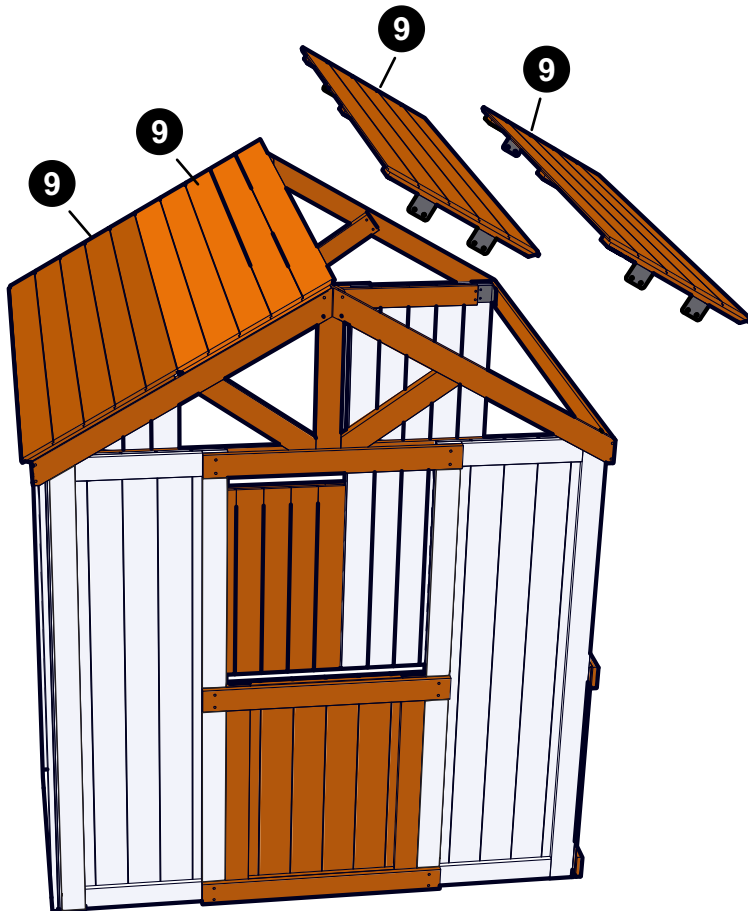

STEP 14

HARDWARE NEEDED (ACTUAL SIZE)

20X



DETAIL A

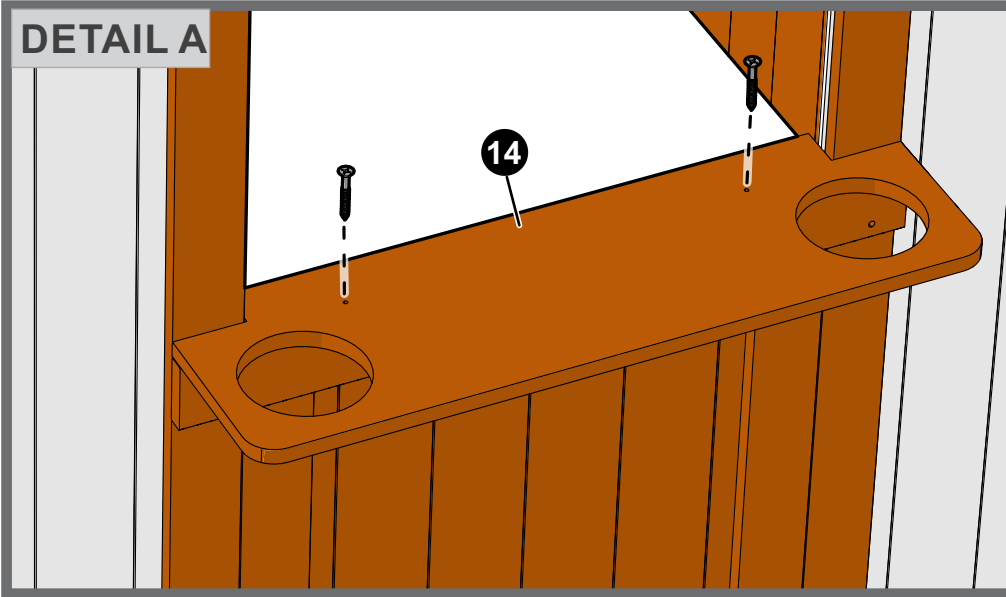

DETAIL B

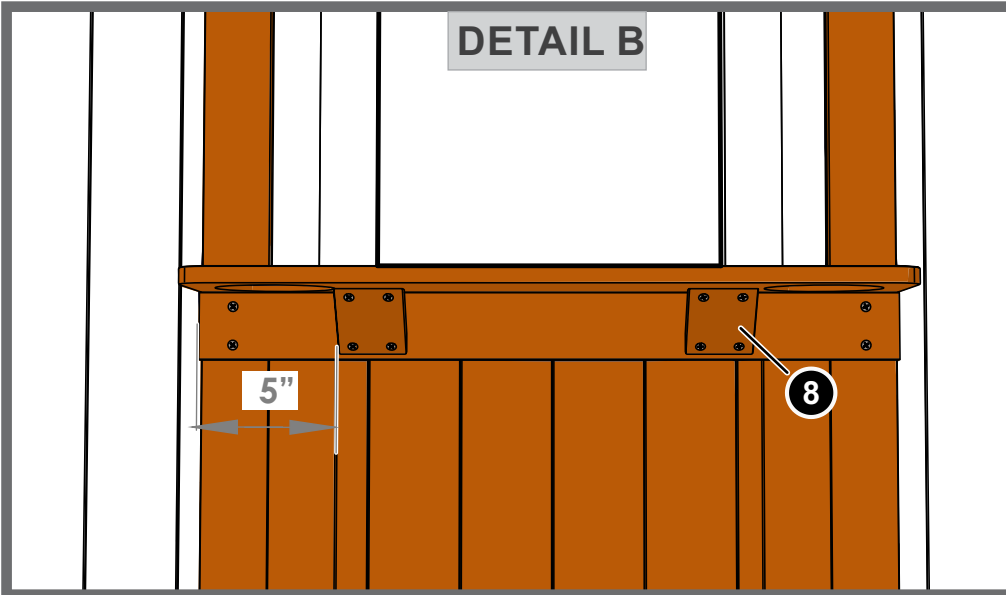

DETAIL C

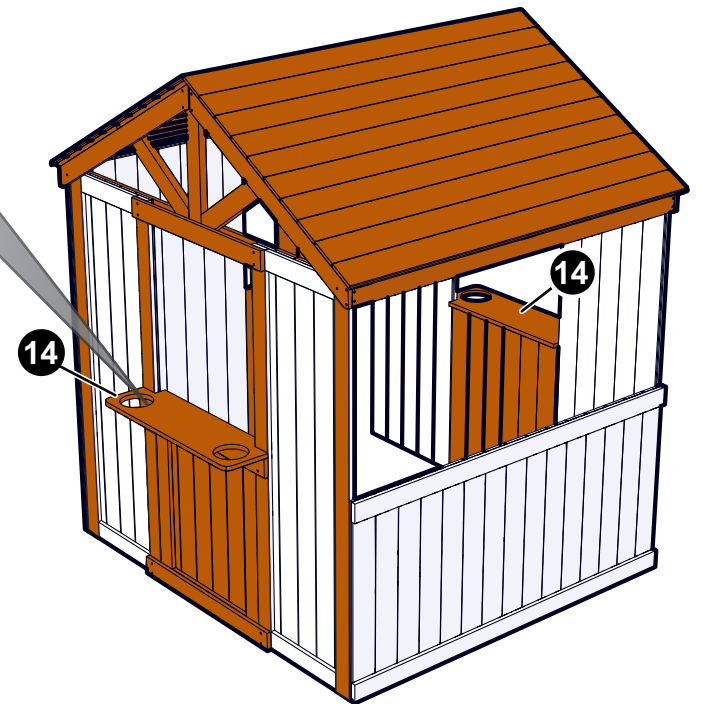
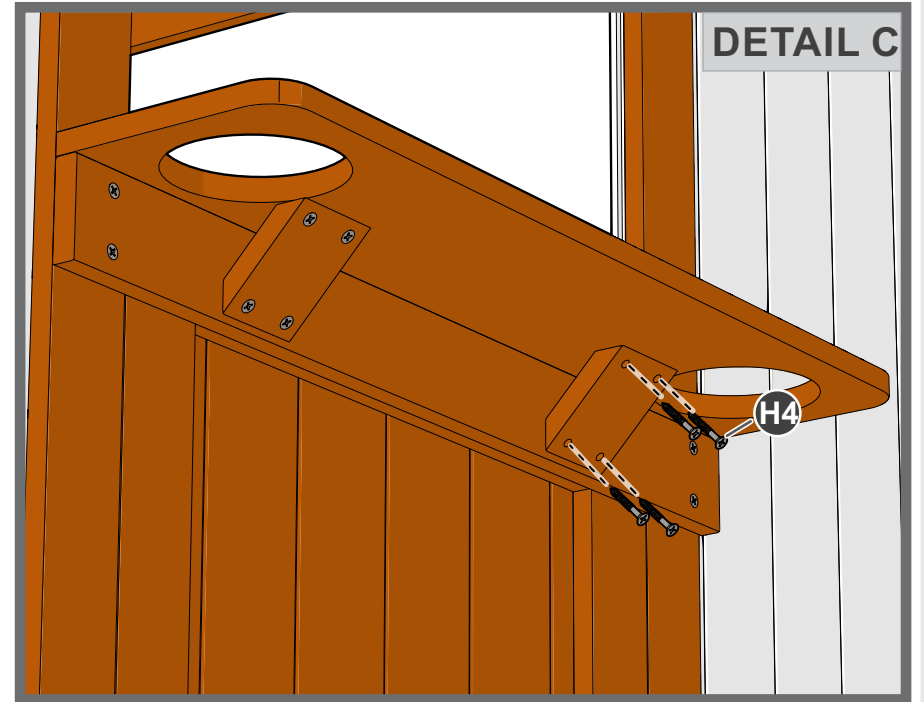

STEP 15

HARDWARE NEEDED (ACTUAL SIZE)

3X



DETAIL A

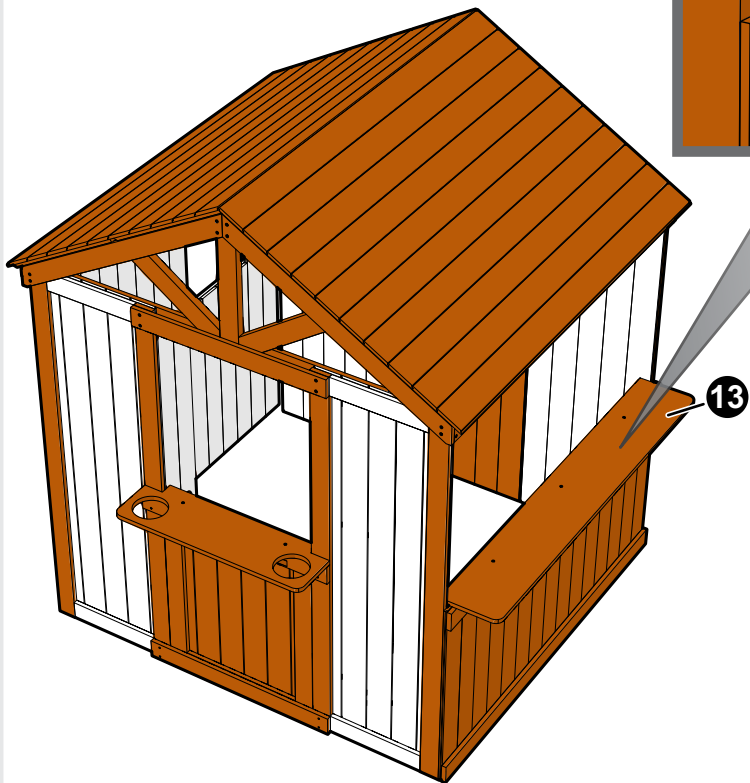
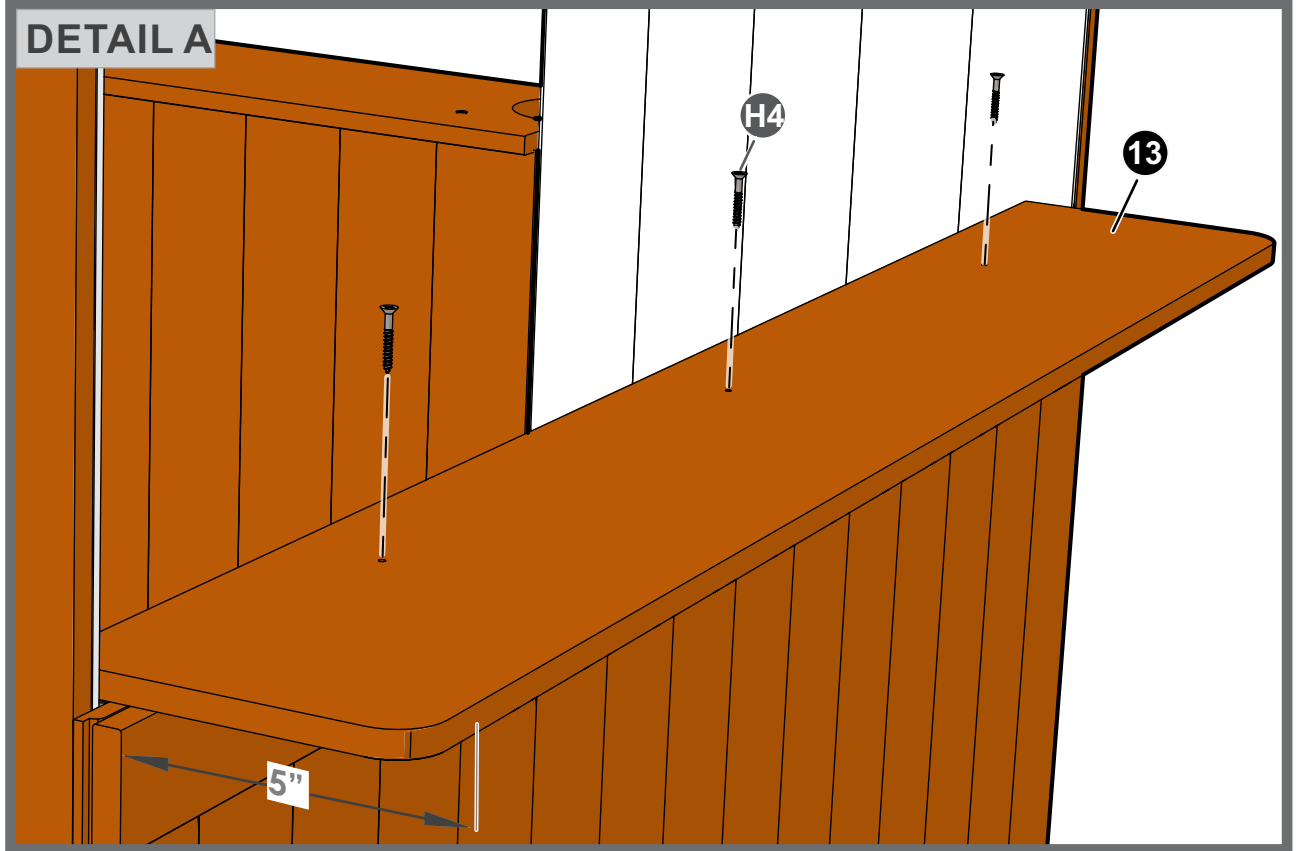

STEP 16

HARDWARE NEEDED (ACTUAL SIZE)

16X

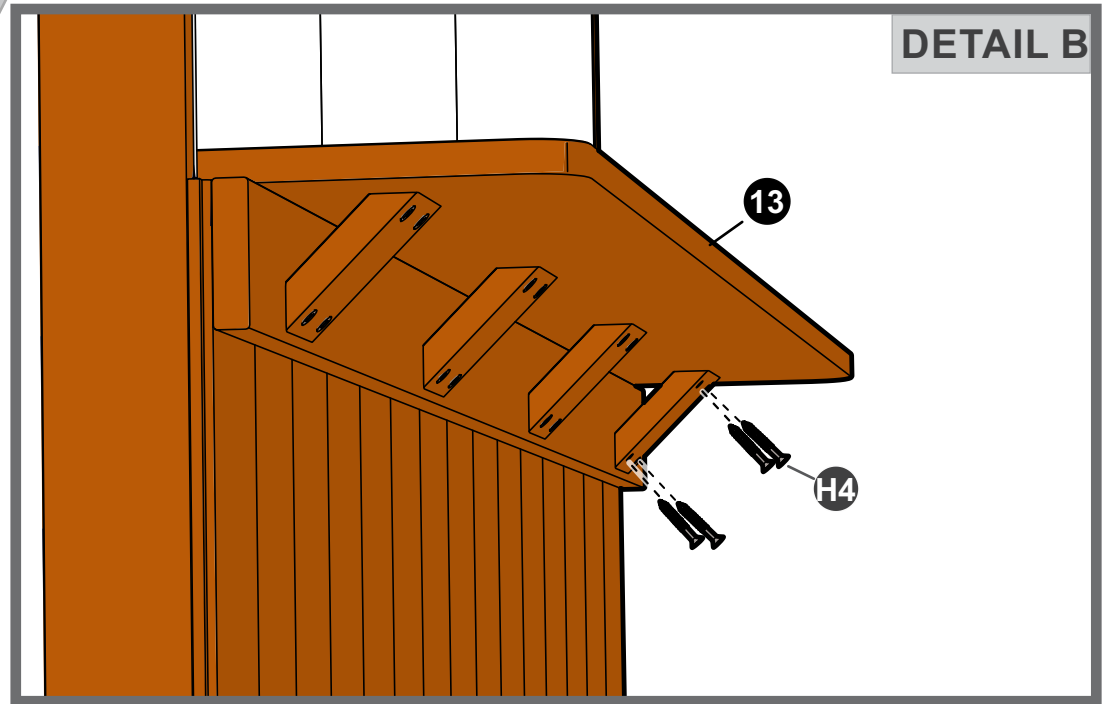
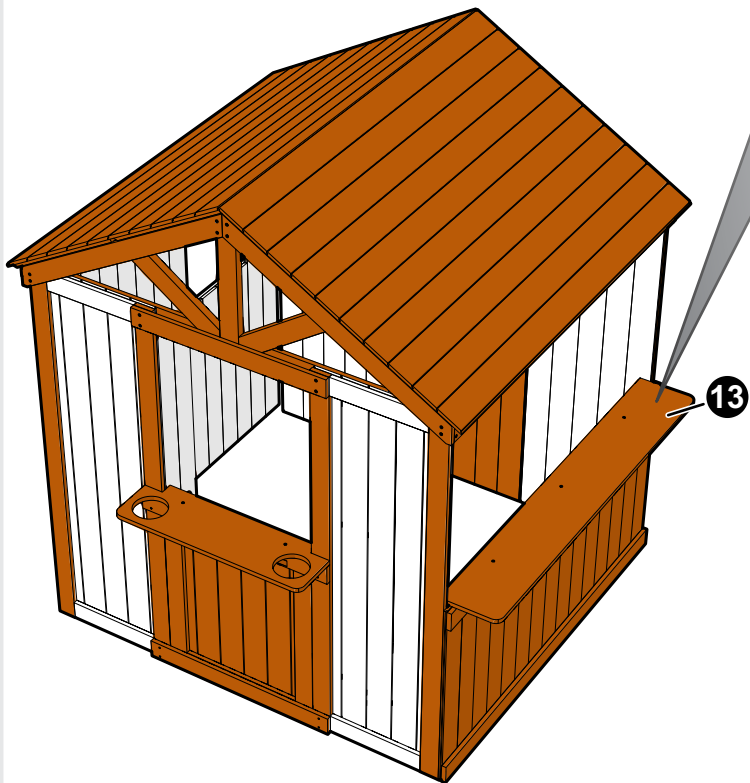
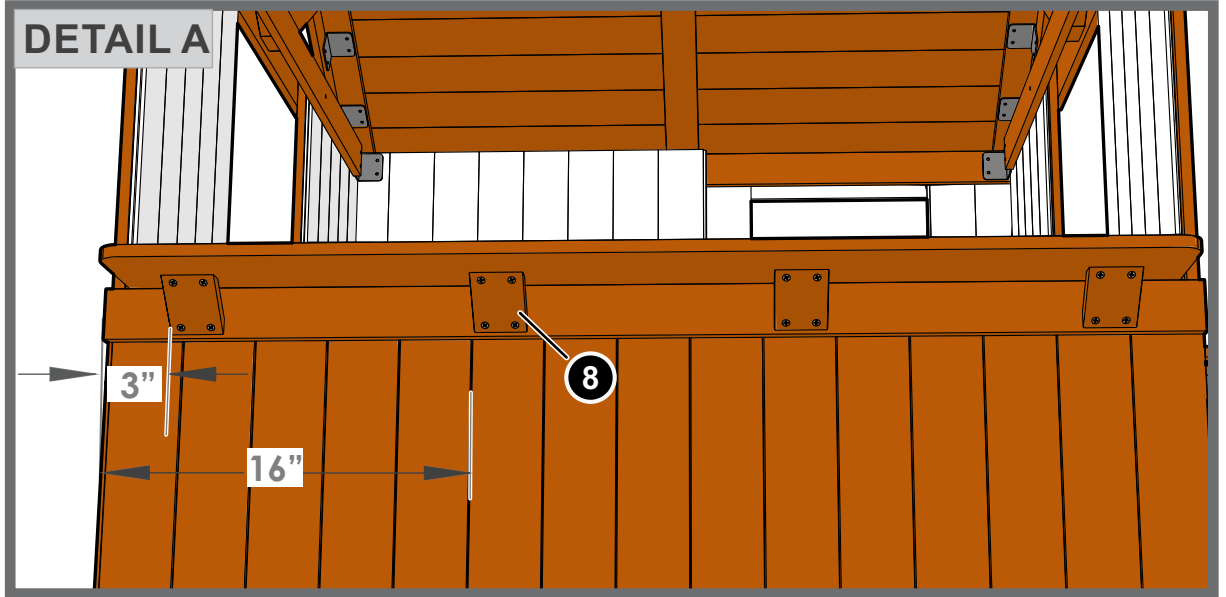
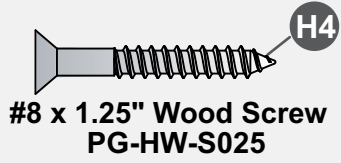

HARDWARE NEEDED (ACTUAL SIZE)

2X



SOCKET BUTTON HEAD CAP SCREW

2X



ROLLER

2X

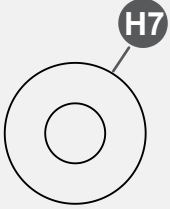

1/4" FLAT WASHER

2X

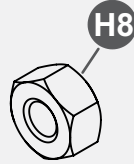

HEX NUT

2X

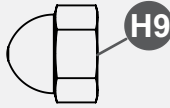

ACORN LOW CROWN NUT

STEP 17

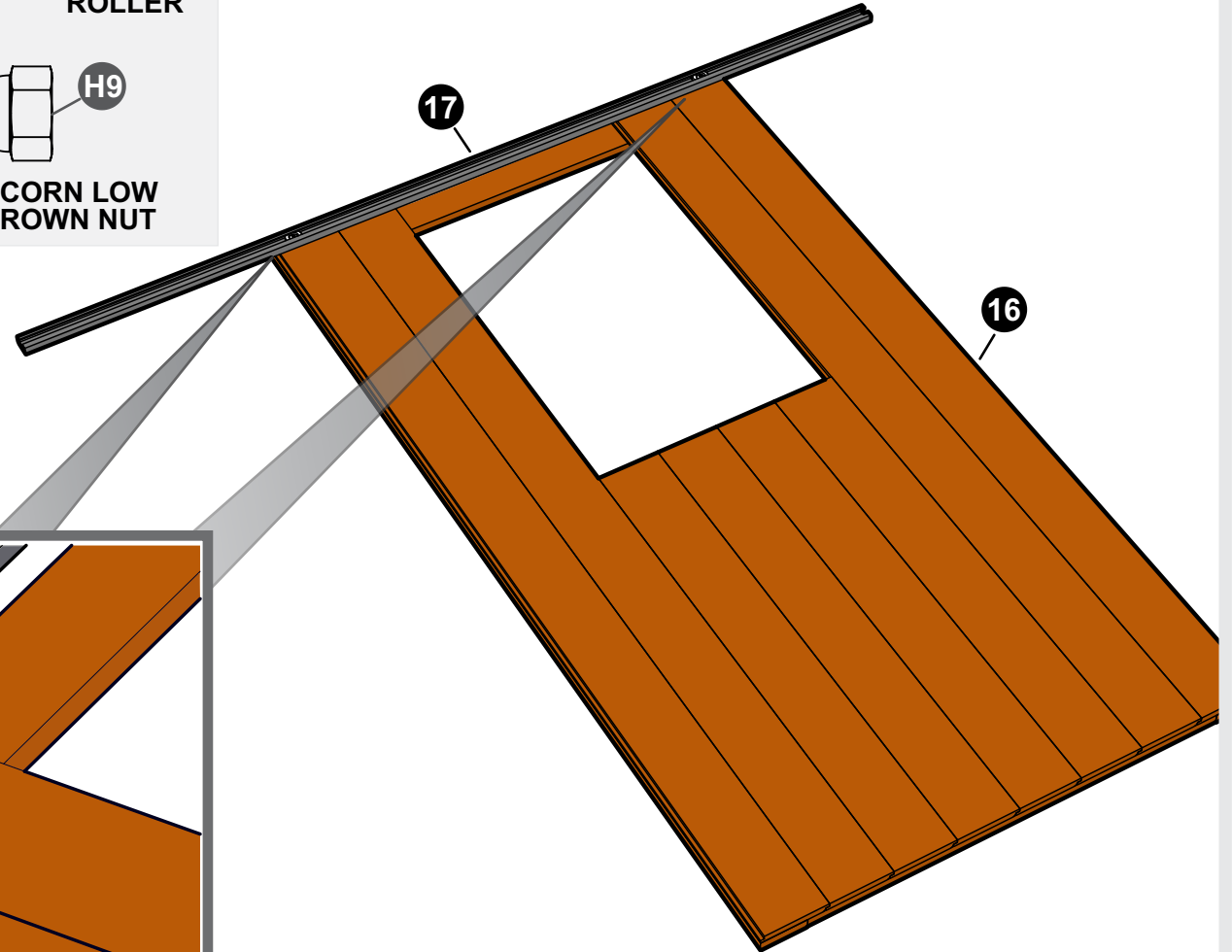

NOTICE
Do not overtighten. Roller should be free to move within rail.

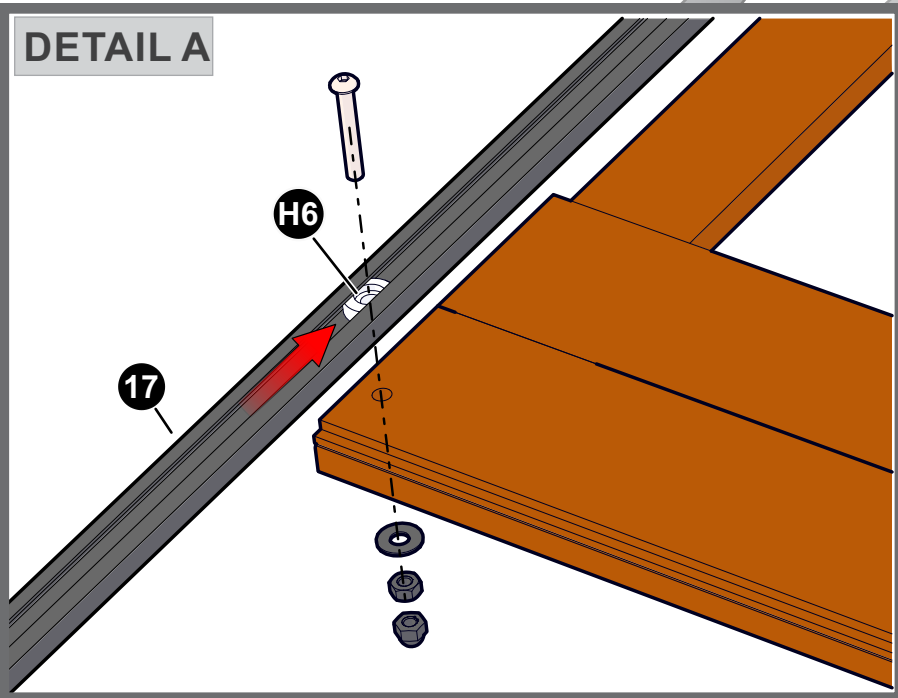

STEP 18

HARDWARE NEEDED (ACTUAL SIZE)

2X

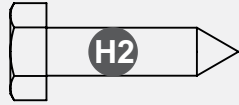

1/4" X 1 LAG SCREW

2X

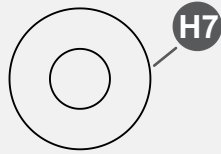

1/4" FLAT WASHER

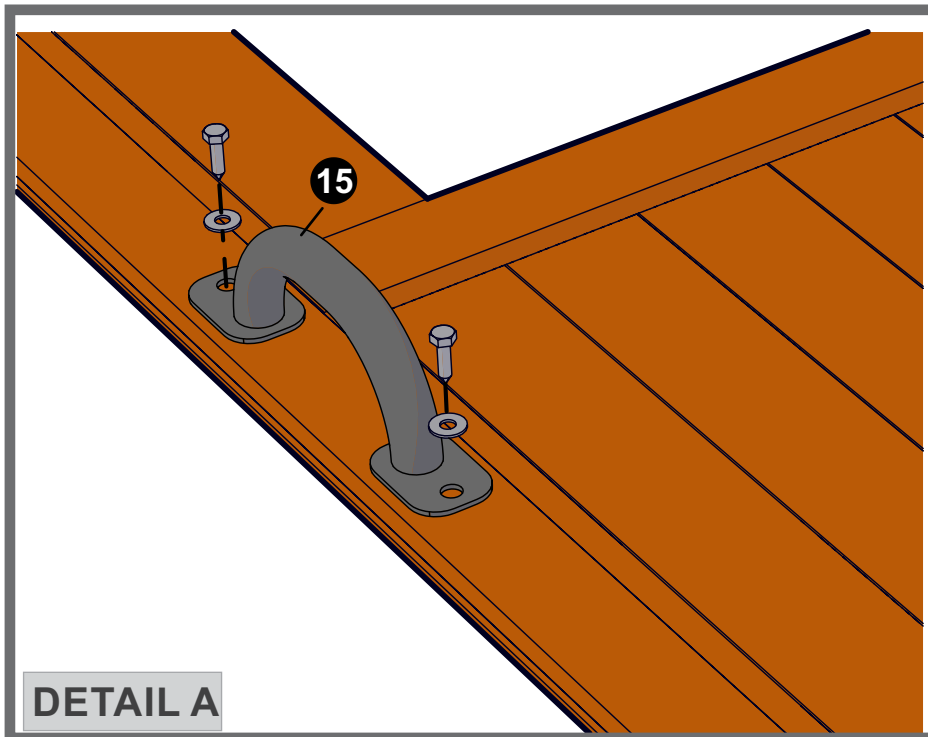
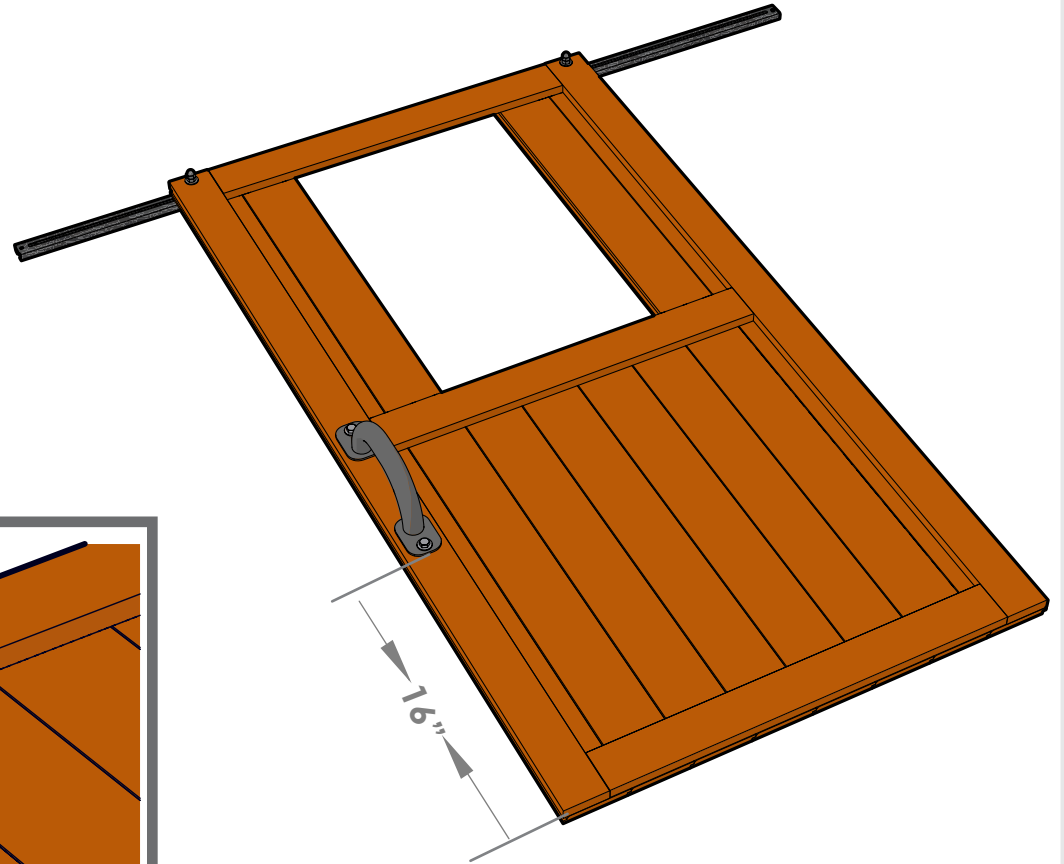

STEP 19

HARDWARE NEEDED (ACTUAL SIZE)

3X

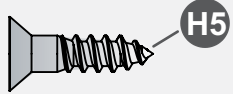

#10 x .75" Wood Screw
PG-HW-S024

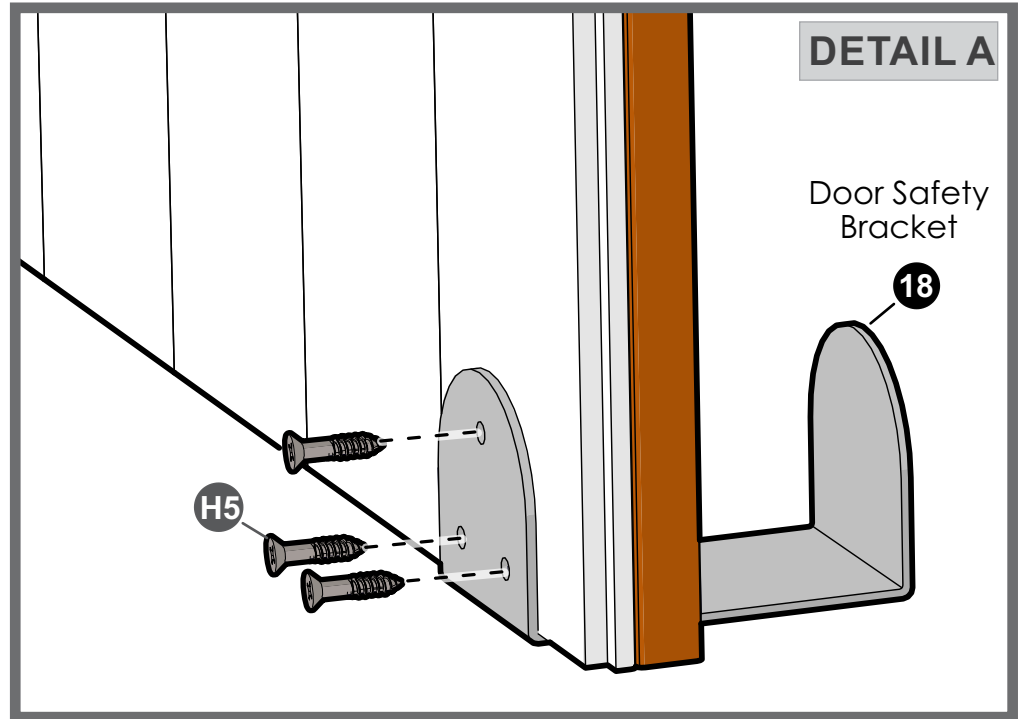
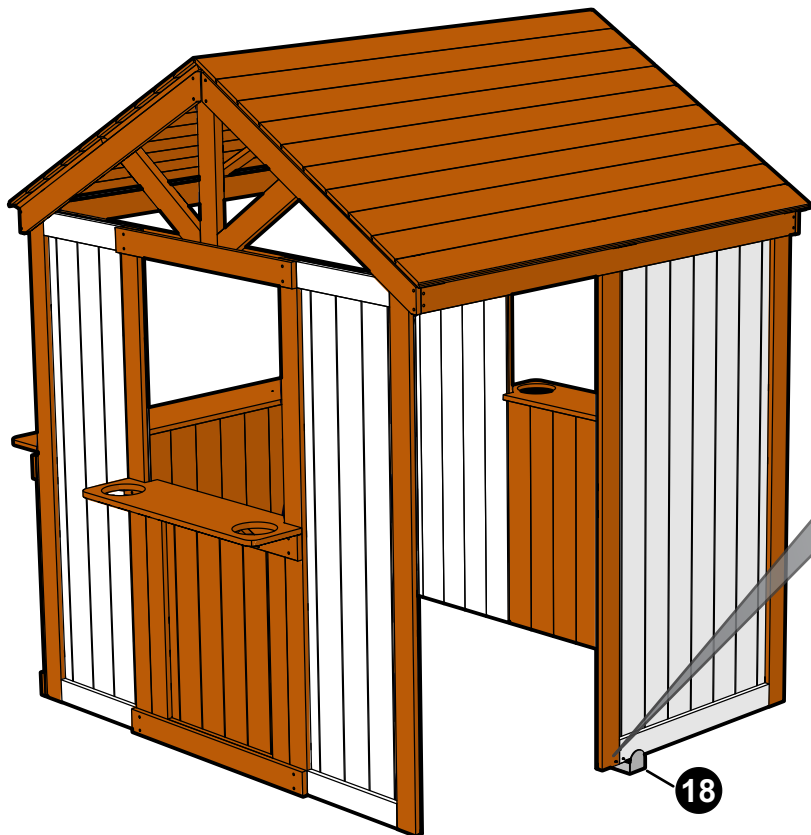

STEP 20

HARDWARE NEEDED (ACTUAL SIZE)

2X

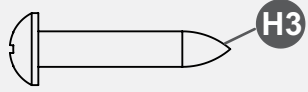

#10 X 1" Round Head Screw
PG-HW-S001

NOTICE

Position Rail (#17) so there is a minimum 1/8" gap between the bottom of the door and the door safety bracket.

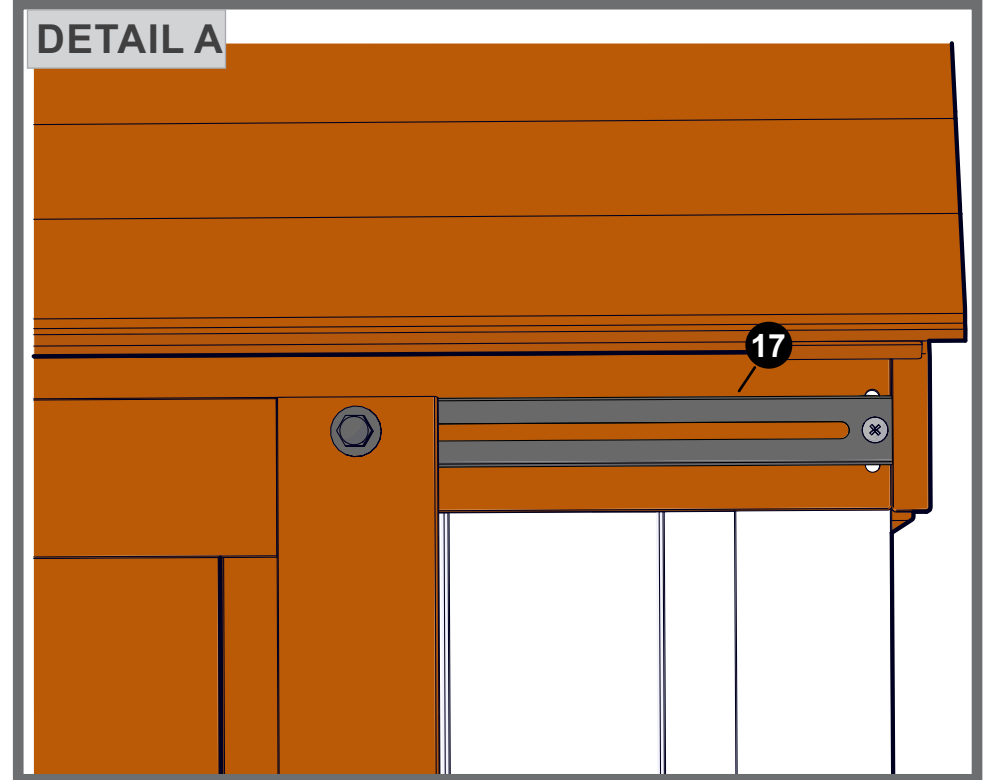
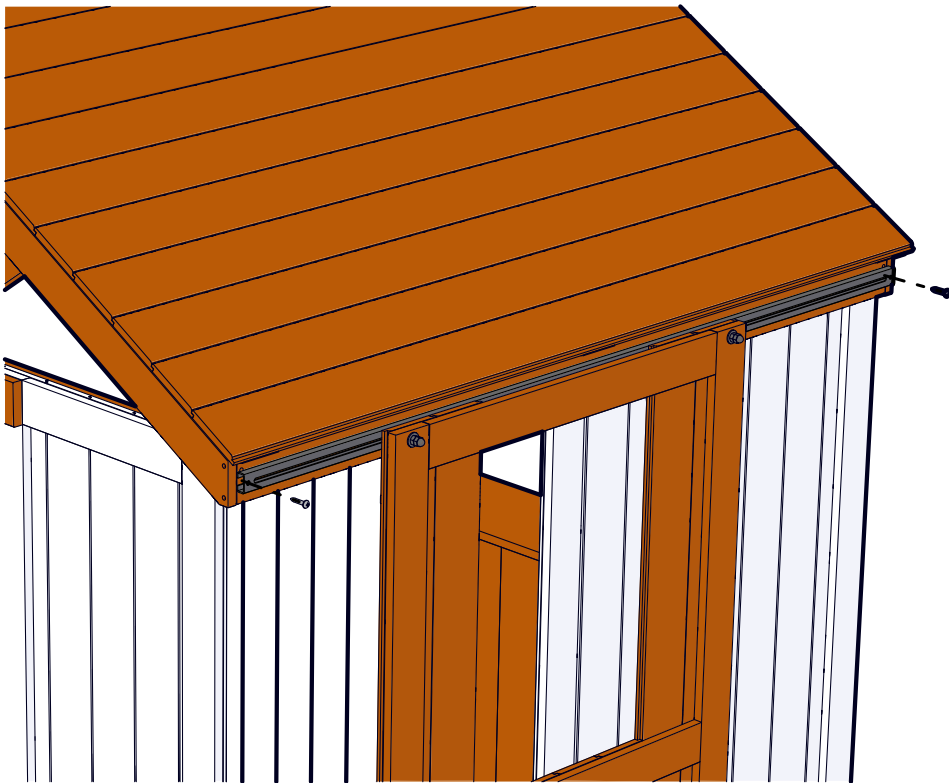

JACK & JUNE WARRANTY

One year after the original purchase date of our **Cedar** playsets, Jack & June warrants, to the original retail purchaser all wooden components against structural failure due to corrosion, wood rot, or insect infestation.

Seasonal checks, surface cracks, knotholes and knots, not resulting in structural failure, are natural characteristics of all wooden play equipment, are not covered under this warranty and will not affect the integrity of your playset.

Timber is a natural material which can absorb and release moisture. Although this product is designed to minimize this effect, in certain circumstances some movement or distortion is unavoidable. During dry hot weather timber may shrink and check - this is a normal process of weathering. After the first year of service it is advisable to clean and apply a non-toxic stain or sealant to the wood, safe for children's use.

Components covered under this **1 year** warranty will be replaced free of charge excluding freight and labor fees.

Non-residential use of the playset is prohibited and voids the warranty as the playsets are designed for residential use only.

Escalade Sports reserves the right to examine photographs and/or physical evidence of merchandise claimed to be defective, and to recover said merchandise, prior to disposition of warranty claims. Merchandise returned to our factory for examination or recovery must be shipped freight prepaid, unless a Return Authorization Number is issued.

This warranty program does not cover normal wear and tear, color fading, or damages resulting from misuse, abuse, vandalism, alteration, acts of God, or assembly and maintenance contrary to our instructions. Escalade Sports assumes no responsibility for incidental or consequential damages which may arise from the purchase or use of our equipment. Please supervise your children's play activity and maintain your play equipment periodically.

This warranty is expressly in lieu of all other warranties, expressed or implied, including warranties of merchantability or fitness for use. Jack & June does not assume or authorize any person to assume for us, any other liability in connection with the sale of our products.

Special Note: Jack & June reserves the right to make changes in materials, design, and pricing without notice. See your instruction manual for maintenance requirements. Your child's safety is your responsibility; therefore, you should inspect this equipment regularly for wear and safety.

For warranty service, contact:

Escalade Sports

P.O. Box 889

Evansville, IN 47706

1-800-GO-SWING

Or E-Mail us at: playgroundcs@escaladesports.com