

Assembly Guide



Bush
FURNITURE



If you're having any difficulty during assembly of this product, don't hesitate to call us at **1-800-950-4782.**

Our customer service experts are trained to provide step-by-step instruction and can easily replace any missing or damaged parts.

**Representatives are available Monday-Friday
from 8:30 a.m. to 7:30 p.m. (ET)**

32W 2 Door Storage Cabinet

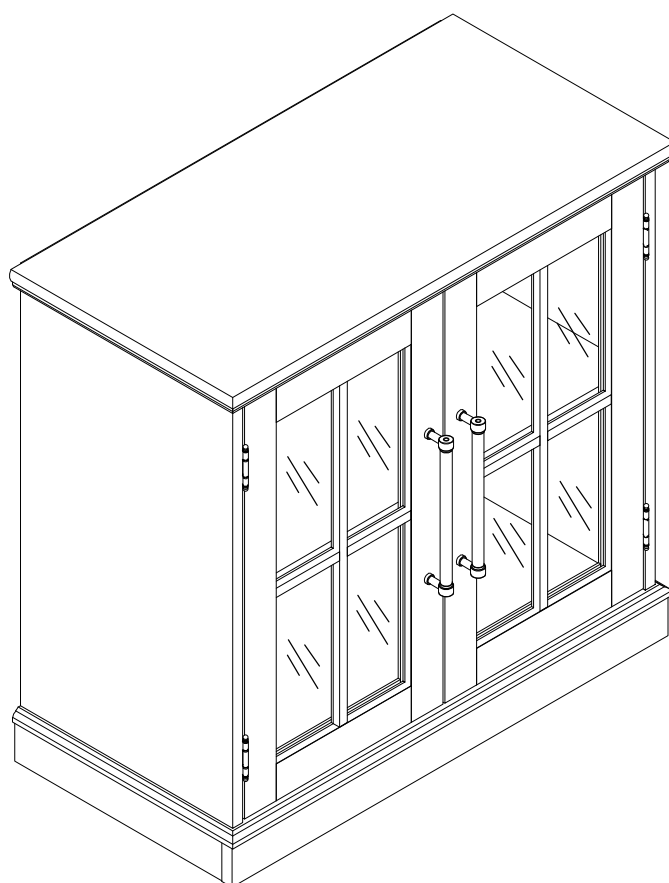

Lot Code #

Part Number A212571

Keep manual for future reference.

Bush[®]

FURNITURE

Thank you for purchasing this Bush Furniture product. We trust that you will be completely satisfied with your product for many years to come. Bush Furniture products are backed by a 1-year warranty and crafted with today's styles in mind for the way you work. **Do not return product to store — contact us first at 1-800-950-4782.**

Merci d'avoir acheté ce produit Bush Furniture. Nous sommes sûr que vous serez complètement satisfait de votre meuble pendant de nombreuses années. Les produits Bush Furniture sont garantis pendant 1 ans et sont conçus dans les styles actuels tout en gardant à l'esprit votre façon de travailler. **Ne renvoyez pas le produit au magasin, contactez-nous d'abord au 1-800-950-4782.**

Gracias por comprar este producto de Bush Furniture. Confiamos que usted estará completamente satisfecho con su mueble por muchos años. Los productos de Bush Furniture tienen 1 años de garantía y son diseñados con los estilos de hoy en mente para la manera que usted vive. **No devuelva el producto a la tienda, primero comuníquese con nosotros al 1-800-950-4782.**

CONTACT US

Monday – Friday
8:30 a.m. – 7:30 p.m. ET
(Except Holidays)

Bush Consumer Services
One Mason Drive, P.O. Box 460
Jamestown, NY 14701
ConsumerService@Bushindustries.com

1-800-950-4782 USA/CANADA
001-800-950-4782 MEXICO

Se habla español
Outside USA/CANADA/MEXICO
001-716-665-2510 Ext. 4514

IT'S AS EASY AS 1,2,3

Assembly tips:

1. Read the instructions and become familiar with the parts.
2. Ensure this carton contains all parts, fasteners and hardware.
3. To protect floors, assemble the furniture on the carton.
4. An assistant may be helpful.
5. Use of power tools is not recommended.

Conseils d'assemblage:

1. Lisez les instructions et familiarisez-vous avec les pièces.
2. Assurez-vous que le carton contient toutes les pièces, toutes les pièces de fixation et toute la quincaillerie.
3. Pour protéger vos sols, assemblez le meuble sur le carton.
4. Il peut être utile de vous faire aider.
5. L'utilisation d'outils électriques n'est pas recommandée.

Consejos de Ensamblaje:

1. Lea las instrucciones y familiarícese con las partes.
2. Asegúrese de que esta caja contenga todas las piezas, los sujetadores y el equipo.
3. Para proteger el piso, ensamble el mueble en el carton.
4. Un asistente puede serle útil.
5. El uso de herramientas eléctricas no se recomienda.



CONSUMER SERVICE

YOU CAN DEPEND ON

Questions? Operators are standing by at our TOLL-FREE help line to assist you with assembly; and, if necessary, to quickly replace damaged/missing parts. Assistance is available 5 days a week. Simply have your store receipt, instruction manual, and part number/description ready when you call our TOLL-FREE help line. It's that easy.

UN SERVICE CLIENTELE SUR LEQUEL VOUS POUVEZ COMPTER
Des questions? Des opérateurs sont prêts sur notre ligne d'assistance GRATUITE pour vous aider à l'assemblage et, si nécessaire, remplacer rapidement les pièces endommagées/manquantes. L'assistance est disponible 5 jours par semaine. Ayez simplement votre reçu de magasin, votre manuel d'instruction et le numéro de pièces/description à votre disposition lorsque vous appelez notre ligne d'assistance GRATUITE. C'est aussi simple que ça.

SERVICIO AL CONSUMIDOR CON EL QUE PUEDE CONTAR
¿Preguntas? Los operadores están listos para ayudarlo con el ensamblaje a través de una línea de ayuda GRATUITA, y en caso de ser necesario, reemplazar de inmediato las piezas dañadas o faltantes. La asistencia está disponible los 5 días de la semana. Solamente tenga listos su recibo de compra, manual de indicaciones y número/descripción de la pieza al momento de llamarnos a la línea de ayuda GRATUITA. Es así de sencillo.

www.bushfurniture.com

For best results, keep these tips in mind:

- ① We know you want to finish this assembly as quickly as possible, but trust us: you'll have a better experience if you take it one step at a time.
- ② Give yourself some room to work near where you want the fully assembled product.
- ③ If your floor isn't carpeted, assemble this product on the empty carton to avoid scratching.
- ④ Do you have a friend who owes you a favor? Some steps may go a little easier with a second set of hands.

DOs

- ✔ Use a #2 Phillips head screwdriver (or other handheld tools as indicated)
- ✔ Wear safety glasses at all times during assembly
- ✔ Carefully follow the instructions in this guide and complete all steps in order
- ✔ Give us a call if you're having trouble with a particularly tricky step

DON'Ts

- ✘ We know power tools are quick and easy, but you shouldn't use them when assembling this product (unless otherwise specified)
- ✘ Never move your furniture with items inside or resting on the surface
- ✘ Do not attempt to use this product before all steps have been completed

**Watch assembly videos right on your phone or computer!**

Some steps include QR codes that link to helpful videos. Watch out for the icon below! Simply open up your smartphone camera to scan the code.

(Users of older smartphones may need to install a QR Reader.)

SCAN HERE**FOR VIDEOS**

Or visit <https://bushfurniture.com/help-faq/#assembling>

IMPORTANT SAFETY INFORMATION



PLEASE READ WARNINGS

Improper use can cause safety hazards, or damage to your furniture and household items.

Warning	Do	Don't	Why it's important
Serious injury may occur.	<ul style="list-style-type: none">Assemble following all instructions using all indicated parts and hardware provided.Install every indicated nail and/or screw.Verify furniture is stable on it's own.Place heaviest items in the lower drawers or shelves.Remove items that might tempt kids to climb, such as toys and remote controls from the top and upper shelves of furniture.	<ul style="list-style-type: none">Do not move unit when loaded.Do not load with a television or other heavy equipment.Do not exceed the maximum load limits stated in the instructions.Do not allow children to stand, climb, or hang on furniture.	Improper assembly, use or loading can lead to product instability, tipover, or collapse.

Advertencia	Hacer	No	Por qué es importante
Pueden producirse lesiones graves.	<ul style="list-style-type: none">Realice el montaje siguiendo todas las instrucciones y utilizando todas las piezas indicadas y los herrajes suministrados.Instale todos los clavos y/o tornillos indicados.Compruebe que el mueble sea estable por sí mismo.Coloque los objetos más pesados en los cajones o estantes inferiores.Retire los objetos que puedan tentar a los niños a trepar, como juguetes y mandos a distancia, de los estantes superiores y superiores del mueble.	<ul style="list-style-type: none">No mueva la unidad cuando esté cargada.No cargue el mueble con un televisor u otro equipo pesado.No supere los límites máximos de carga indicados en las instrucciones.No permita que los niños se pongan de pie, trepen o se cuelguen de los muebles.	El montaje, uso o carga inadecuados pueden provocar inestabilidad, vuelco o colapso del producto.

IMPORTANT SAFETY INFORMATION



PLEASE READ WARNINGS

Improper use can cause safety hazards, or damage to your furniture and household items.

Avertissement	À faire	À ne pas faire	Pourquoi c'est important
Peut entraîner des blessures graves.	<ul style="list-style-type: none">• Assembler en suivant toutes les instructions et en utilisant toutes les pièces et la quincaillerie incluses.• Installer tous les clous et/ou toutes les vis.• Assurez-vous que le meuble soit stable par lui-même.• Placer les objets les plus lourds sur les tablettes ou dans les tiroirs du bas.• Retirer les objets qui pourraient inciter les enfants à grimper comme les jouets et les télécommandes des tablettes supérieures et du dessus du meuble.	<ul style="list-style-type: none">• Ne pas déplacer le meuble lorsqu'il est chargé.• Ne pas charger le meuble avec un téléviseur ou tout autre équipement lourd• Ne pas dépasser les limites de poids maximales indiquées dans les instructions.• Ne pas laisser les enfants se tenir sur les meubles, y grimper ou s'y suspendre.	Un assemblage, une utilisation ou un chargement incorrects peuvent entraîner l'instabilité, le basculement ou l'effondrement du produit.

IMPORTANT SAFETY INFORMATION



PLEASE READ WARNINGS

Improper use can cause safety hazards, or damage to your furniture and household items.

Caution	Do	Don't	Why it's important
Serious injury may occur.	<ul style="list-style-type: none">• Handle glass carefully during assembly.• Use proper eye and hand protection.	<ul style="list-style-type: none">• Do not exceed maximum load limits stated in the instructions.	<ul style="list-style-type: none">• Improper handling or loading may result in glass breakage.

Atención	Hacer	No	Por qué es importante
Pueden producirse lesiones graves.	<ul style="list-style-type: none">• Manipule el vidrio con cuidado durante el montaje.• Utilice protección adecuada para los ojos y las manos.	<ul style="list-style-type: none">• No supere los límites máximos de carga indicados en las instrucciones.	<ul style="list-style-type: none">• Una manipulación o carga inadecuada puede provocar la rotura del vidrio.

Attention	À faire	À ne pas faire	Pourquoi c'est important
Peut entraîner des blessures graves.	<ul style="list-style-type: none">• Manipuler le verre avec précaution pendant l'assemblage.• Utiliser une bonne protection pour les yeux et les mains.	<ul style="list-style-type: none">• Ne pas dépasser les limites de poids maximales indiquées dans les instructions.	<ul style="list-style-type: none">• Une manipulation ou un chargement inadéquats risquent de briser le verre.

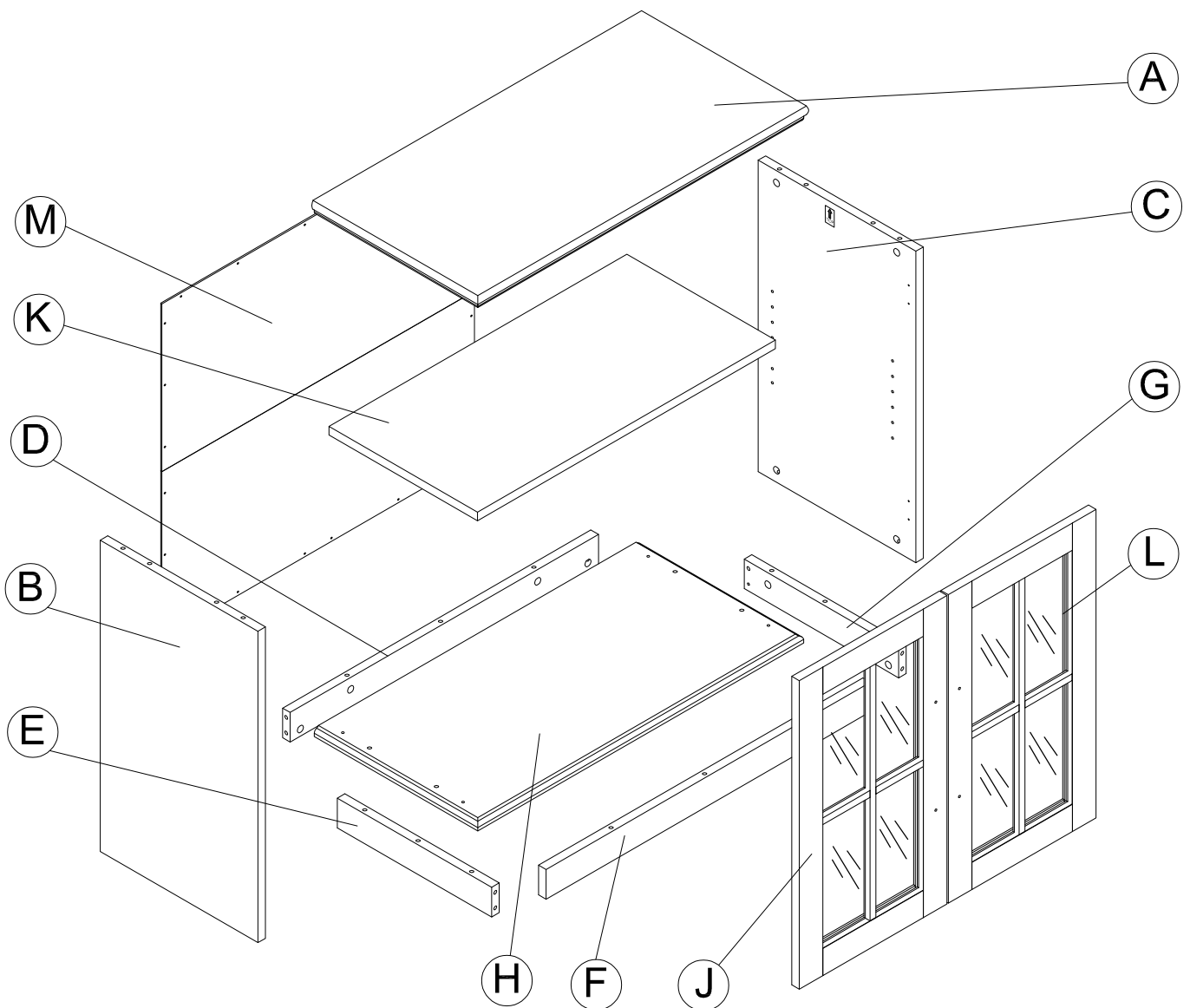
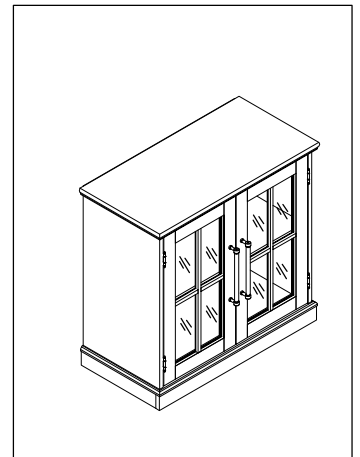

Have an assembly question or need a replacement part? Just call
1-800-950-4782, we are here to help.

Fasteners are shown actual size.

H181468

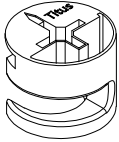

KD Cam

[20]

H72988

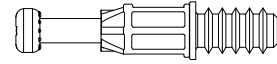

KD Bolt

[20]

H38169

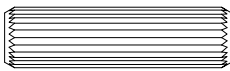

Wood Dowel
8 x 30mm

[16]

H211548

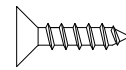

#8 x 5/8" BLACK

[16]

H160460

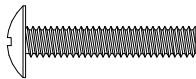

M4 x 22mm

[4]



#3 x 3/4"

[24]

H153243

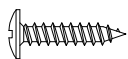

#5 x 9/16"

[2]

H157241

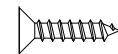

#5 x 1/2"

[4]

Have an assembly question or need a replacement part? Just call
1-800-950-4782, we are here to help.

Hardware not to scale.

H158707

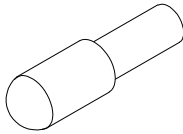

[4]

Shelf Pin

H215607

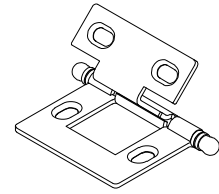

[4]

Hinge

H208051

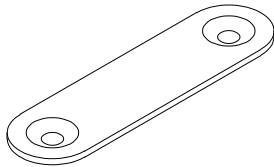

[2]

Strike Plate

H215605

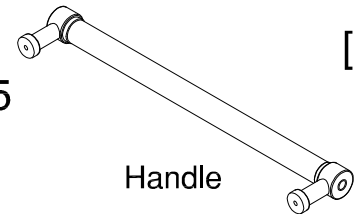

[2]

Handle

H211159

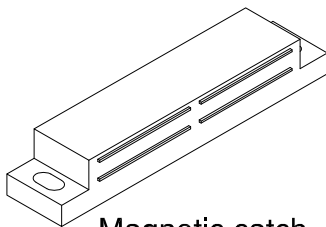

[1]

Magnetic catch



[8]

Cover Cap

Have an assembly question or need a replacement part? Just call
1-800-950-4782, we are here to help.

STEP 1

Prepare Panel

A212571

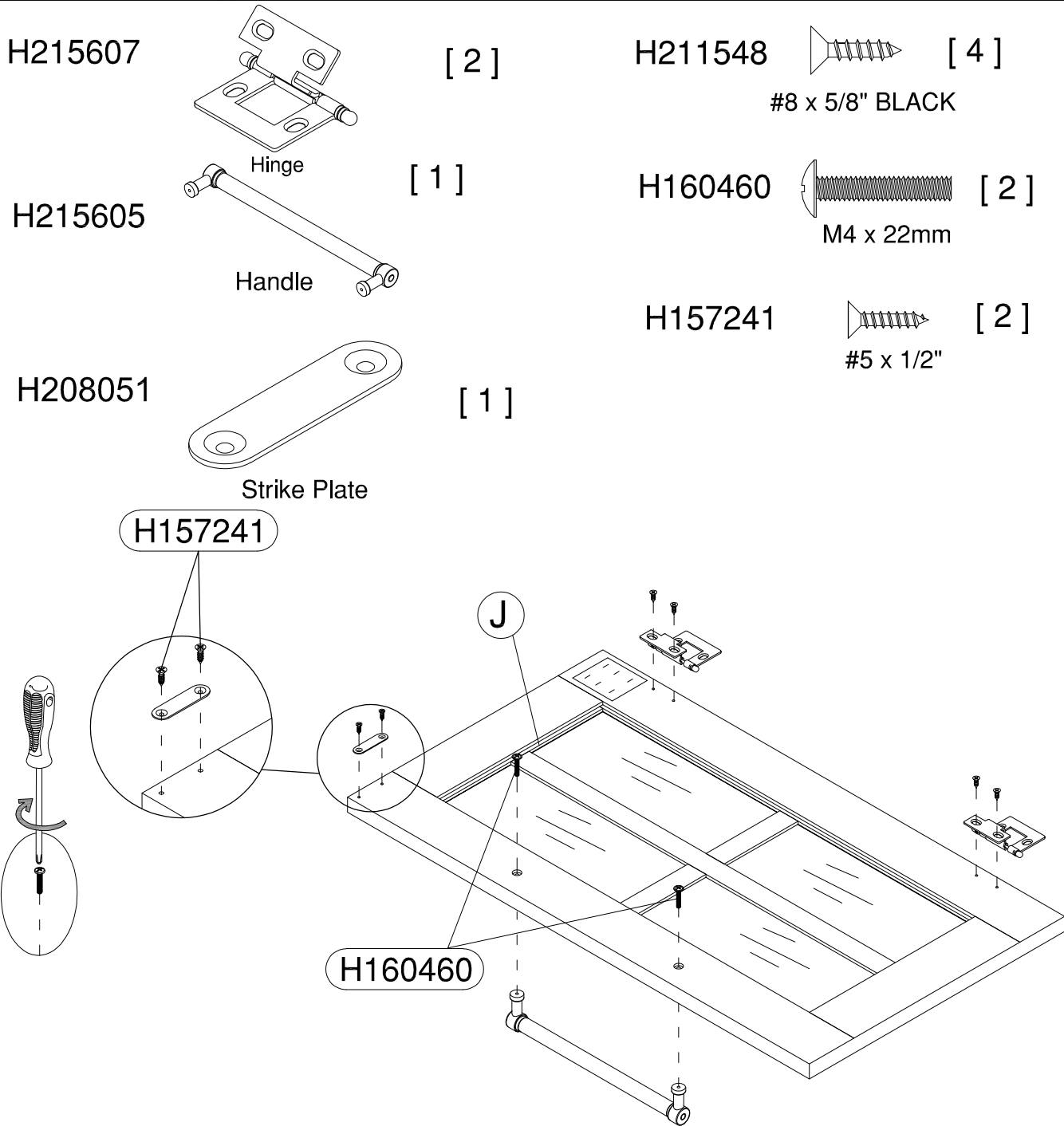

CAUTION



Risk of breaking glass. Handle glass carefully during assembly. Use eye and hand protection. Improper handling can result in cuts or lacerations.

Riesgo de romper el vidrio. Maneje el vidrio con cuidado al ensamblar esta unidad. Use protección para sus ojos y sus manos. El manejo inapropiado del vidrio puede causarle cortaduras o laceraciones.

Risque de bris de verre. Faites attention lors de la manipulation du verre pendant l'assemblage. Utilisez des protections pour les yeux et les mains. Une mauvaise manipulation peut provoquer des coupures ou des lacerations.

Have an assembly question or need a replacement part? Just call
1-800-950-4782, we are here to help.

STEP 2

Prepare Panel

A212571

- H215607 [2] H211548 [4]
#8 x 5/8" BLACK
 - H215605 [1] H160460 [2]
M4 x 22mm
 - H208051 [1] H157241 [2]
#5 x 1/2"
- Hinge
- Handle
- Strike Plate

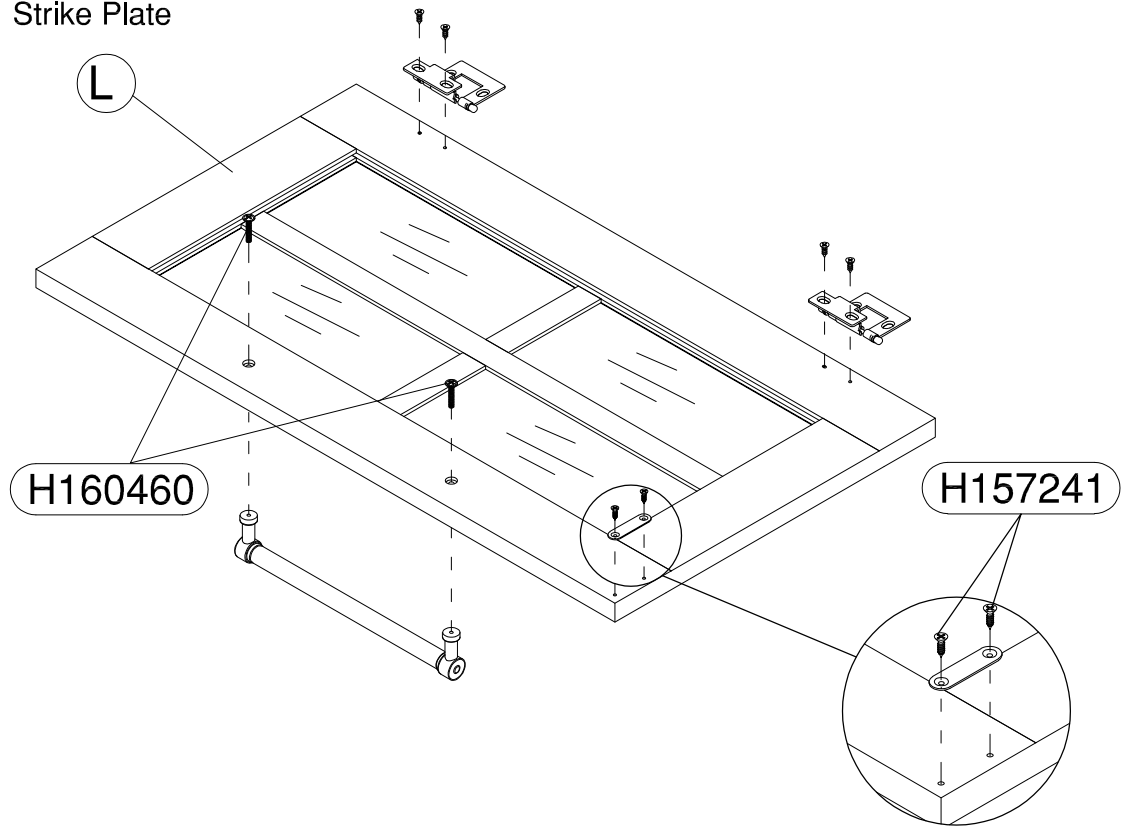
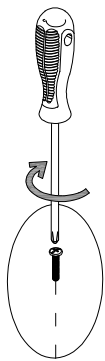

CAUTION



Risk of breaking glass. Handle glass carefully during assembly. Use eye and hand protection. Improper handling can result in cuts or lacerations.

Riesgo de romper el vidrio. Maneje el vidrio con cuidado al ensamblar esta unidad. Use protección para sus ojos y sus manos. El manejo inapropiado del vidrio puede causarle cortaduras o laceraciones.

Risque de bris de verre. Faites attention lors de la manipulation du verre pendant l'assemblage. Utilisez des protections pour les yeux et les mains. Une mauvaise manipulation peut provoquer des coupures ou des lacerations.

Have an assembly question or need a replacement part? Just call **1-800-950-4782**, we are here to help.

STEP 3

Prepare Panels

A212571

H38169

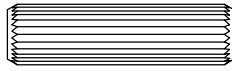

[8]

Wood Dowel
8 x 30mm

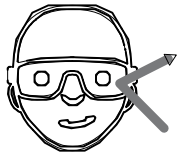

Safety glasses
Gafas de seguridad
Lunettes de protection

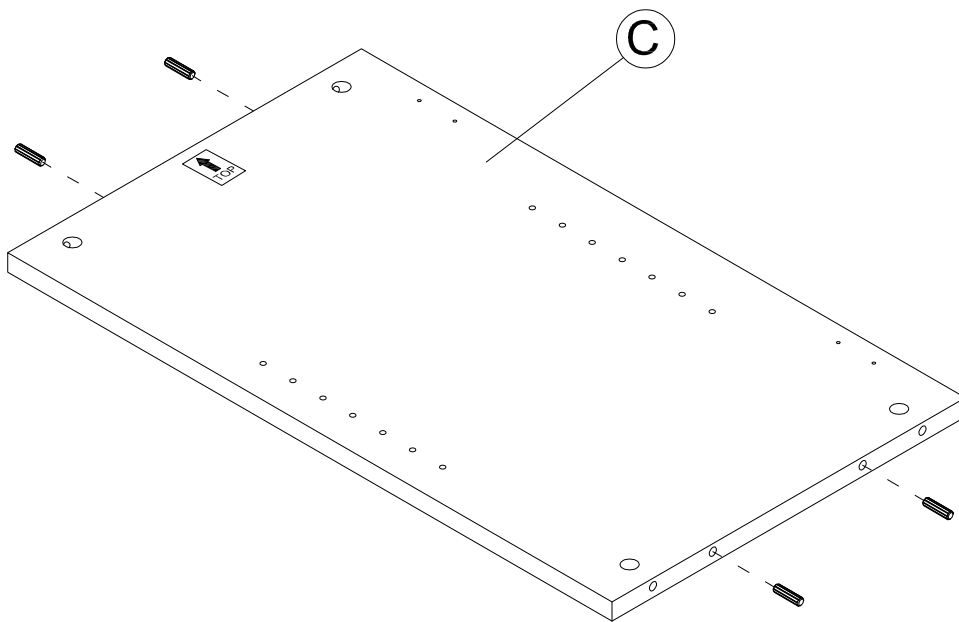
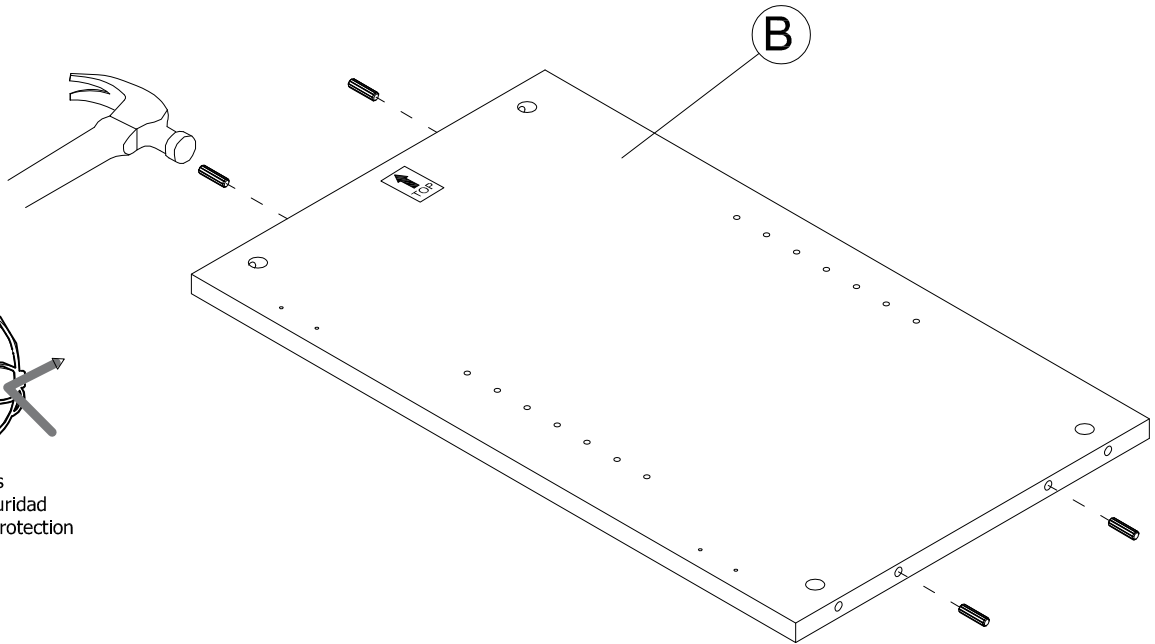

Have an assembly question or need a replacement part? Just call
1-800-950-4782, we are here to help.

STEP 4

Prepare Panel

A212571

H72988

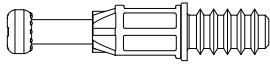

[8]

KD Bolt

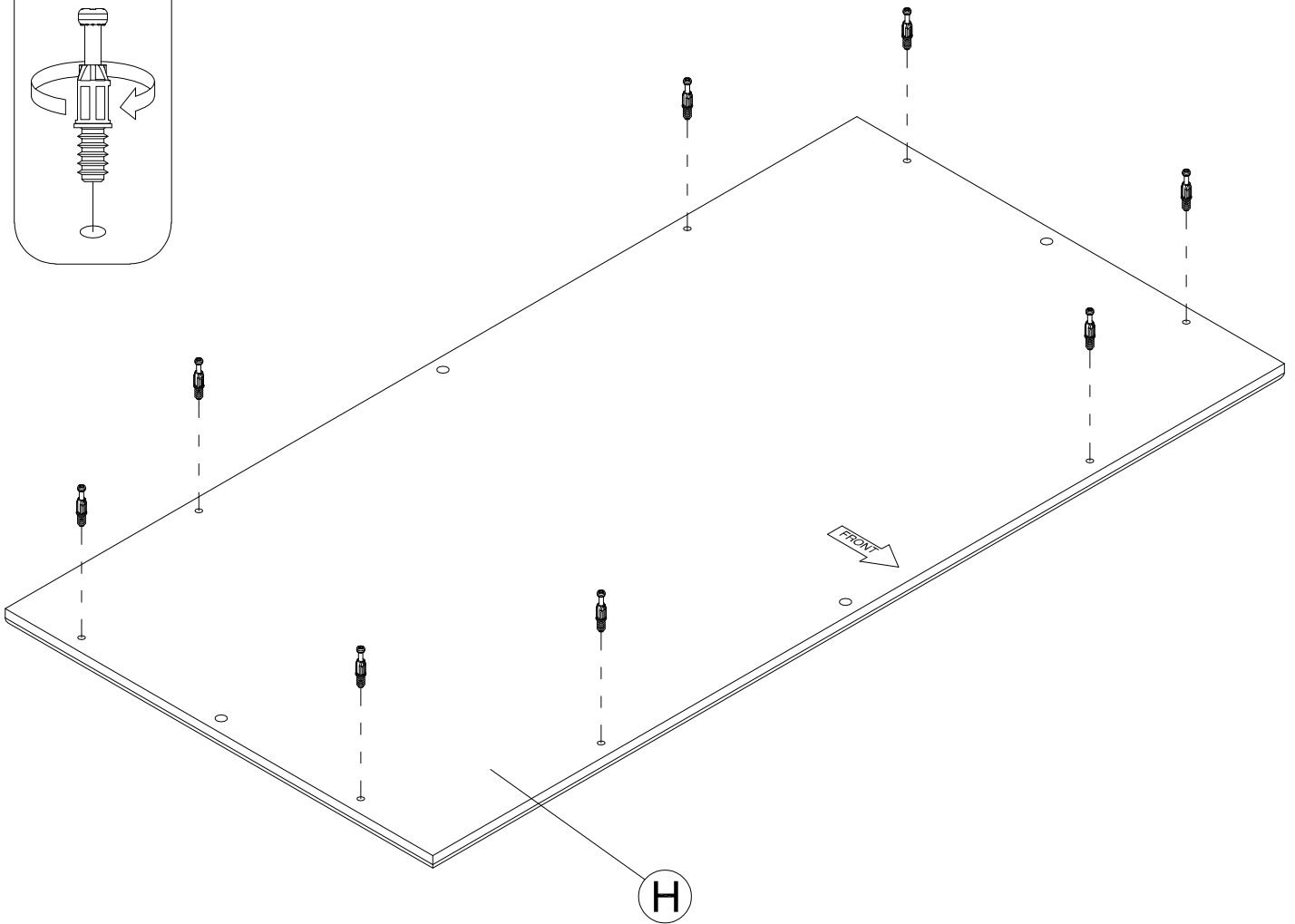
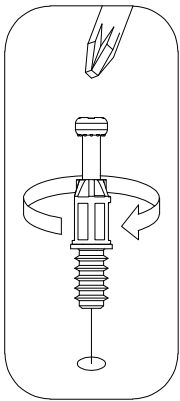

Have an assembly question or need a replacement part? Just call
1-800-950-4782, we are here to help.

STEP 5

Prepare Panels

A212571

H72988

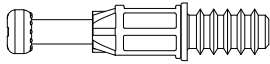

[4]

KD Bolt

H38169

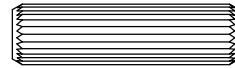

[8]

Wood Dowel
8 x 30mm

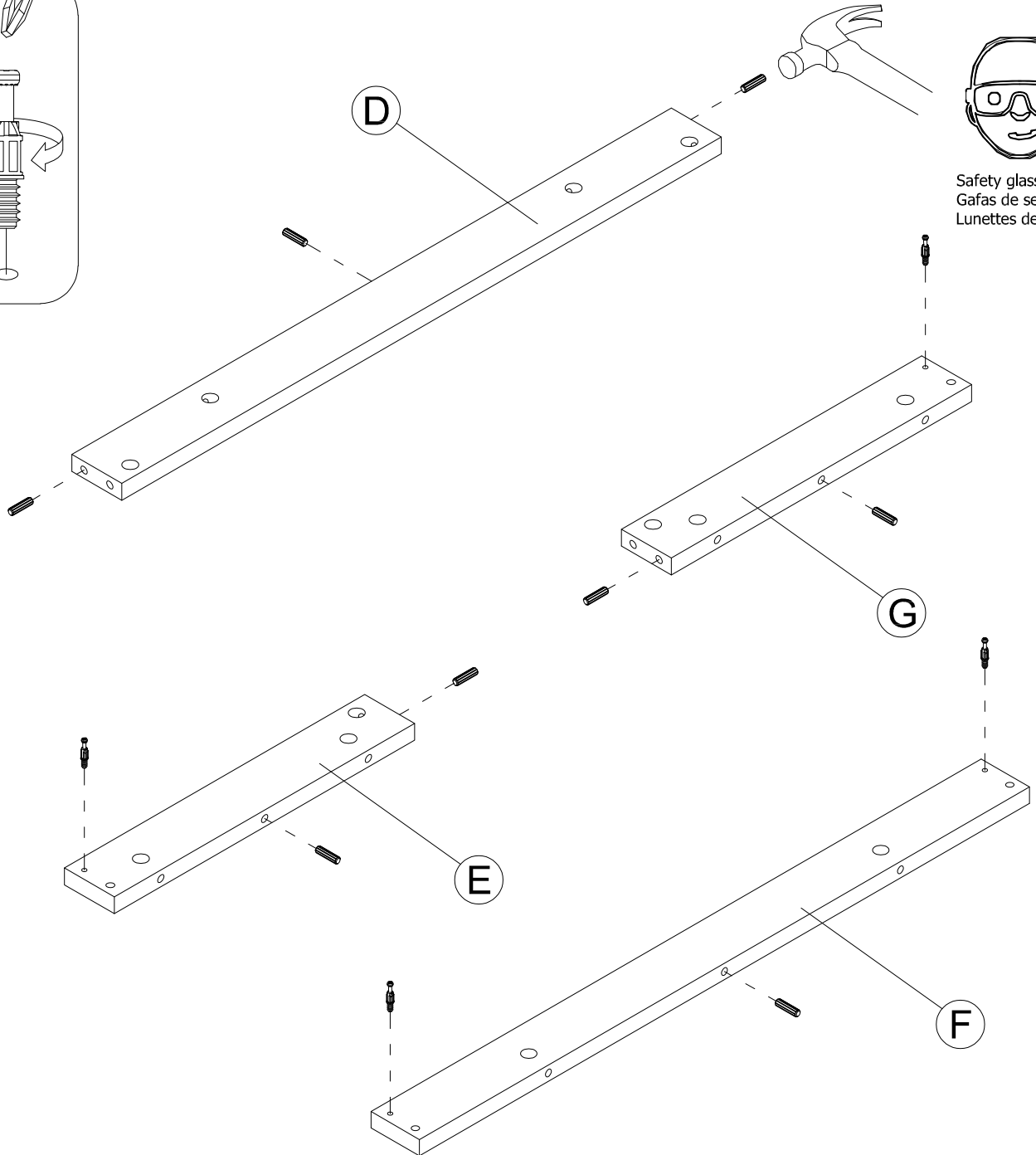
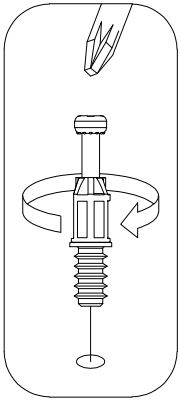

Safety glasses
Gafas de seguridad
Lunettes de protection

Have an assembly question or need a replacement part? Just call
1-800-950-4782, we are here to help.

STEP 6

Assemble Panels

A212571

Scan QR Code to Watch Video on:



How to Tighten KD Cams



H181468

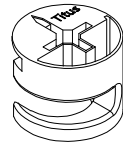

[2]

KD Cam

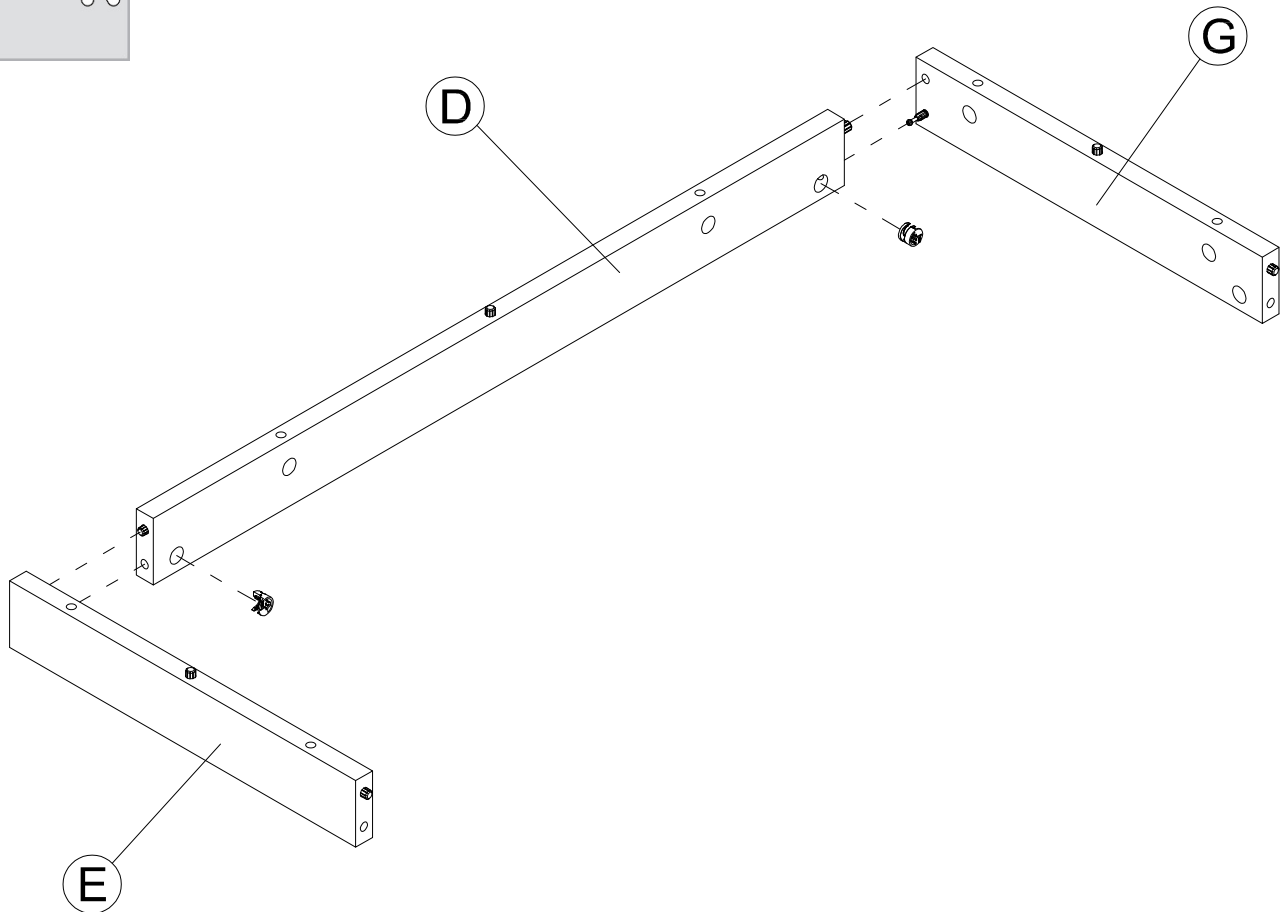
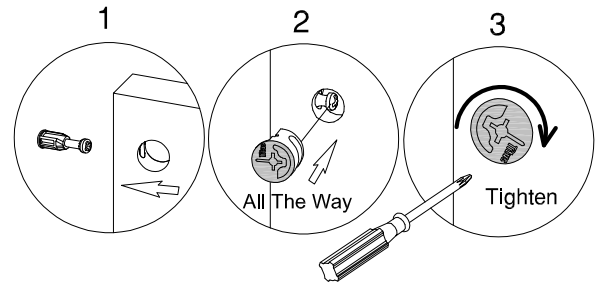

Have an assembly question or need a replacement part? Just call **1-800-950-4782**, we are here to help.

STEP 7

Assemble Panels

A212571

Scan QR Code to Watch Video on:



How to Tighten KD Cams

H181468

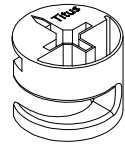

[2]

KD Cam

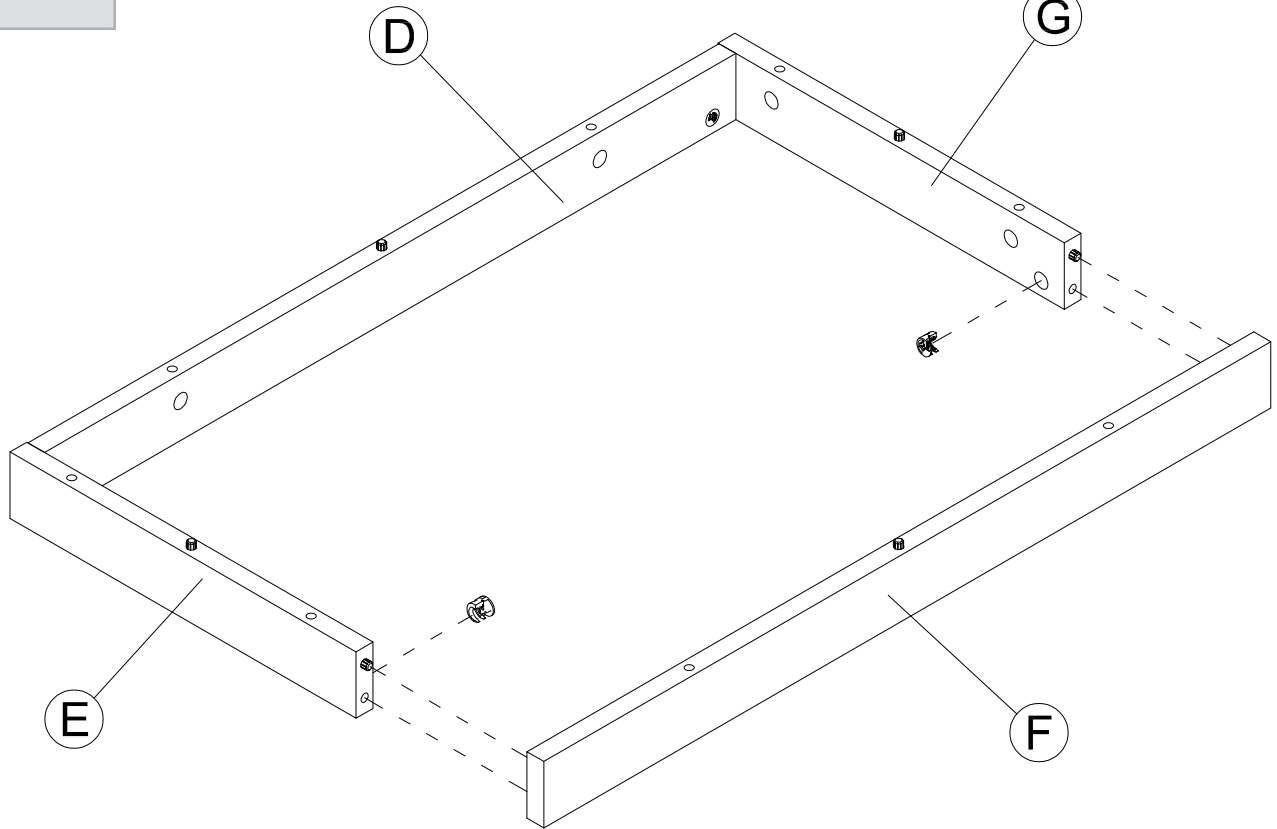
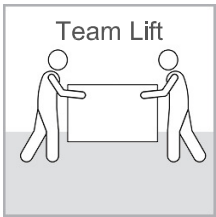
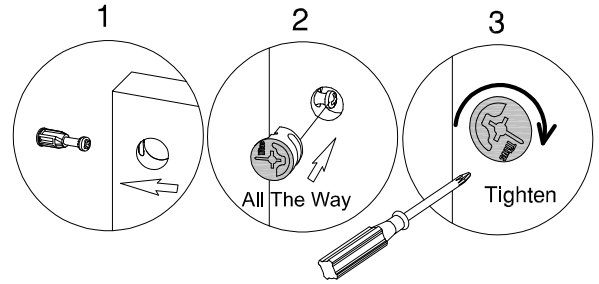

Have an assembly question or need a replacement part? Just call **1-800-950-4782**, we are here to help.

STEP 8

Assemble Panels

A212571

Scan QR Code to Watch Video on:



How to Tighten KD Cams



H181468

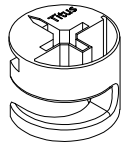

[8]

KD Cam

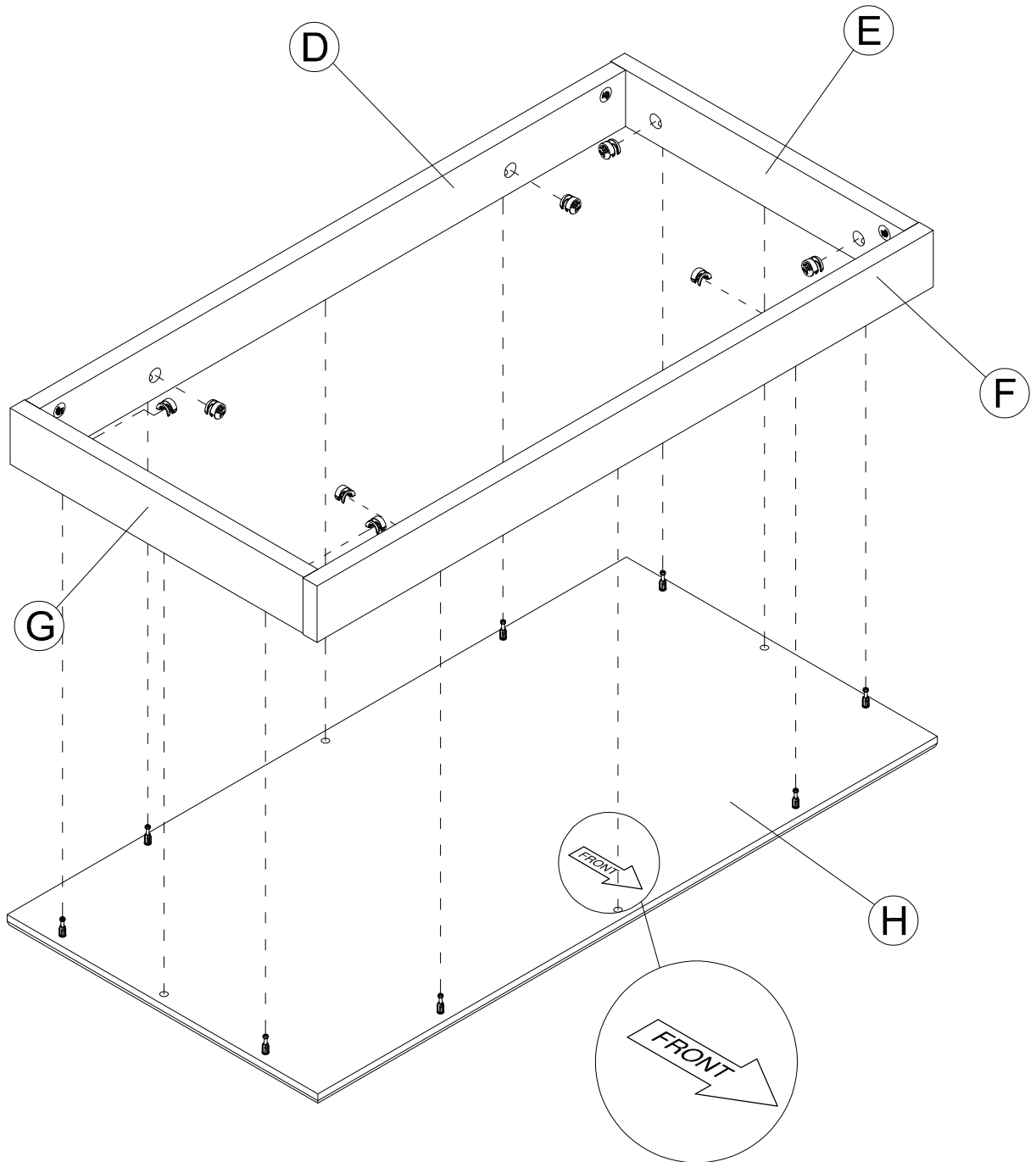
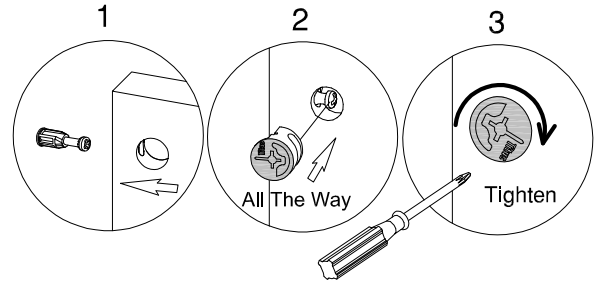

Have an assembly question or need a replacement part? Just call **1-800-950-4782**, we are here to help.

H72988

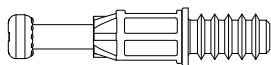

[4]

KD Bolt

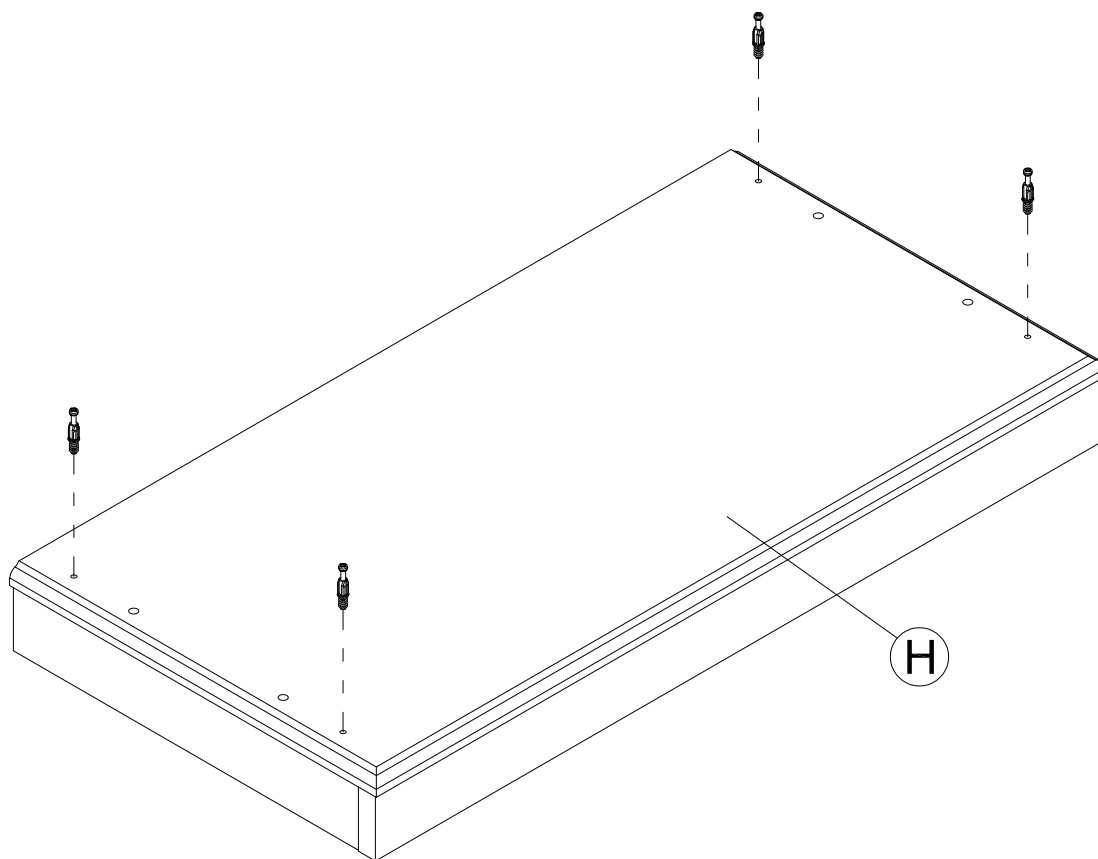
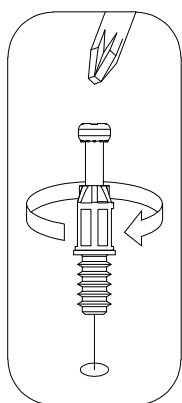

Have an assembly question or need a replacement part? Just call
1-800-950-4782, we are here to help.

STEP 10

Assemble Panels

A212571

Scan QR Code to Watch Video on:



How to Tighten KD Cams

H181468

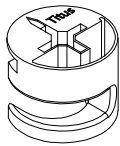

[4]

KD Cam

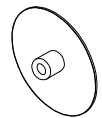

[4]

Cover Cap

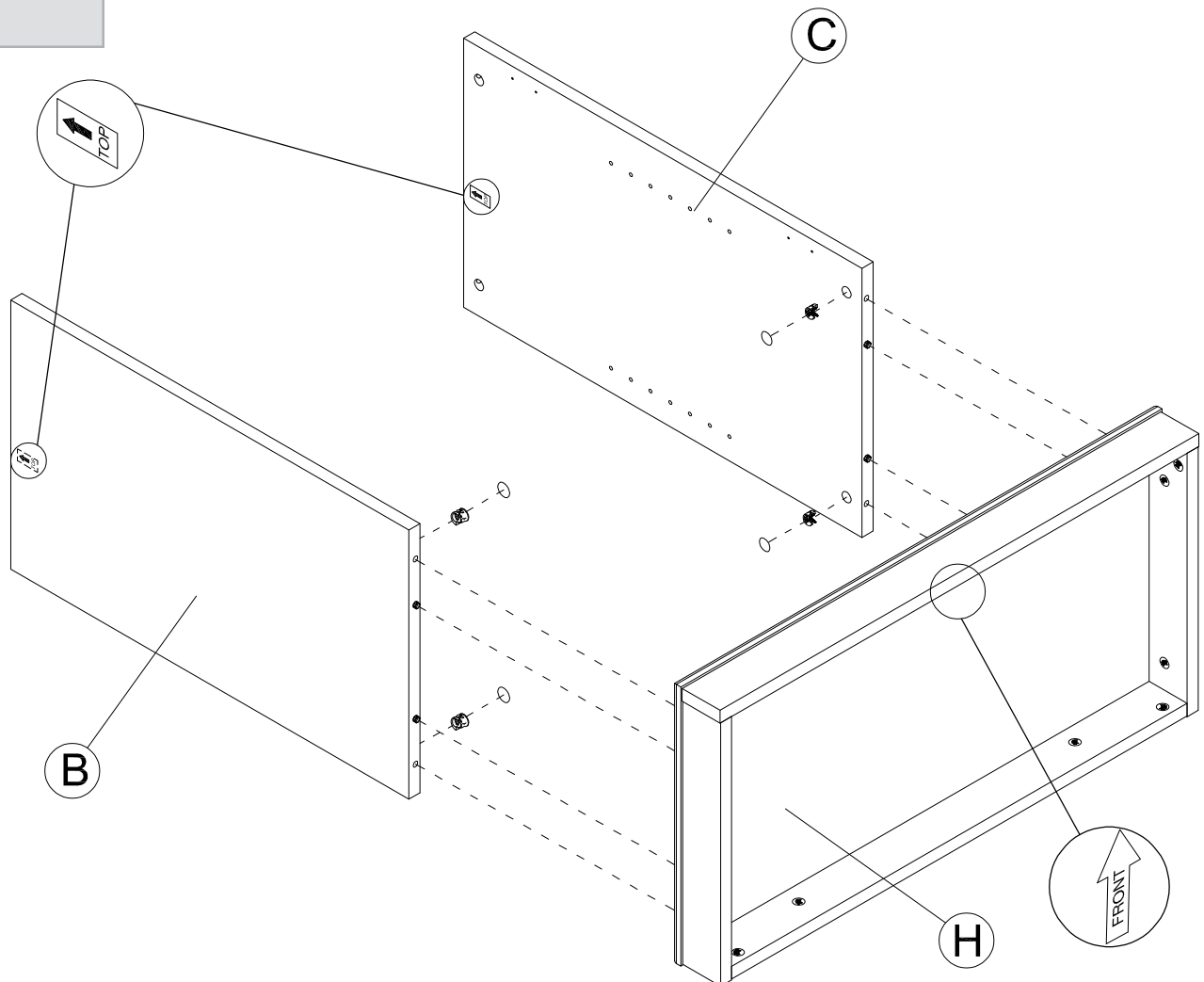
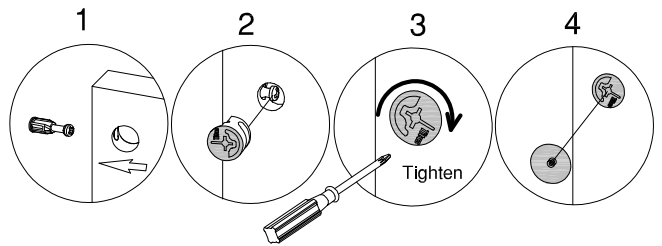

Have an assembly question or need a replacement part? Just call **1-800-950-4782**, we are here to help.

STEP 11

Prepare Panel

A212571

H72988 [4]

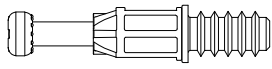

KD Bolt

H153243 [2]

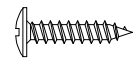

#5 x 9/16"

H211159

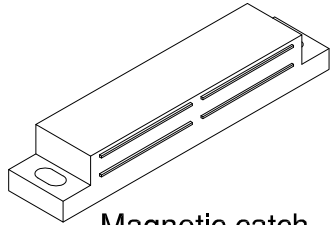

[1]

Magnetic catch

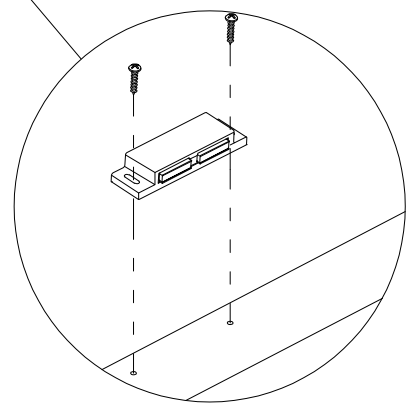
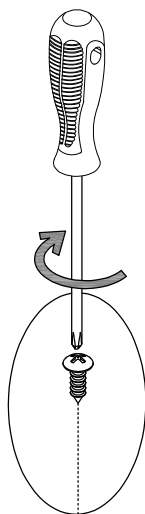
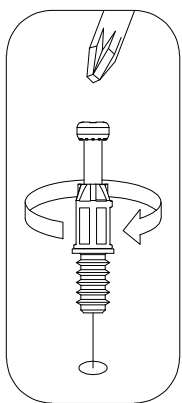
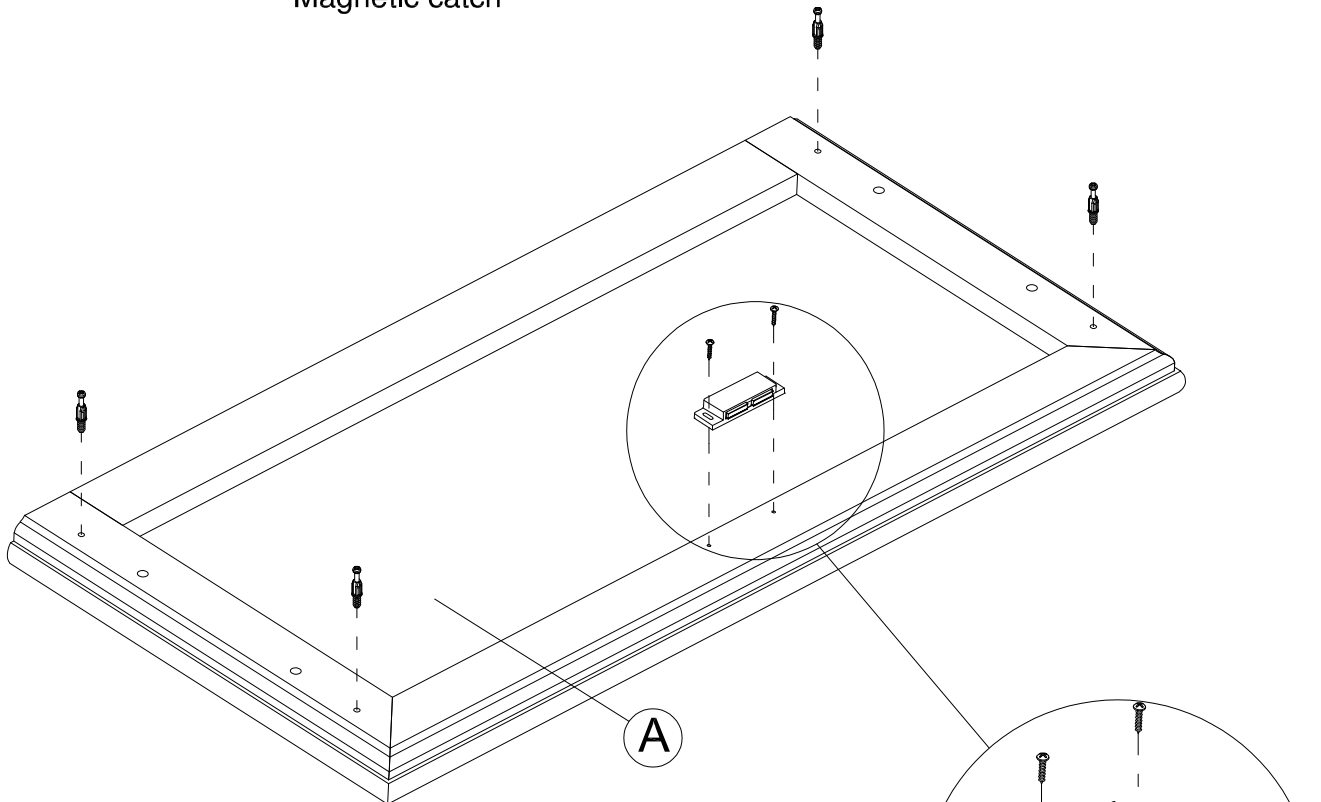

Have an assembly question or need a replacement part? Just call **1-800-950-4782**, we are here to help.

STEP 12

Assemble Panels

A212571

Scan QR Code to Watch Video on:



How to Tighten KD Cams



H181468

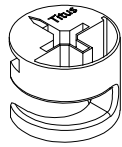

[4]

KD Cam

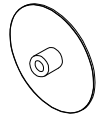

[4]

Cover Cap

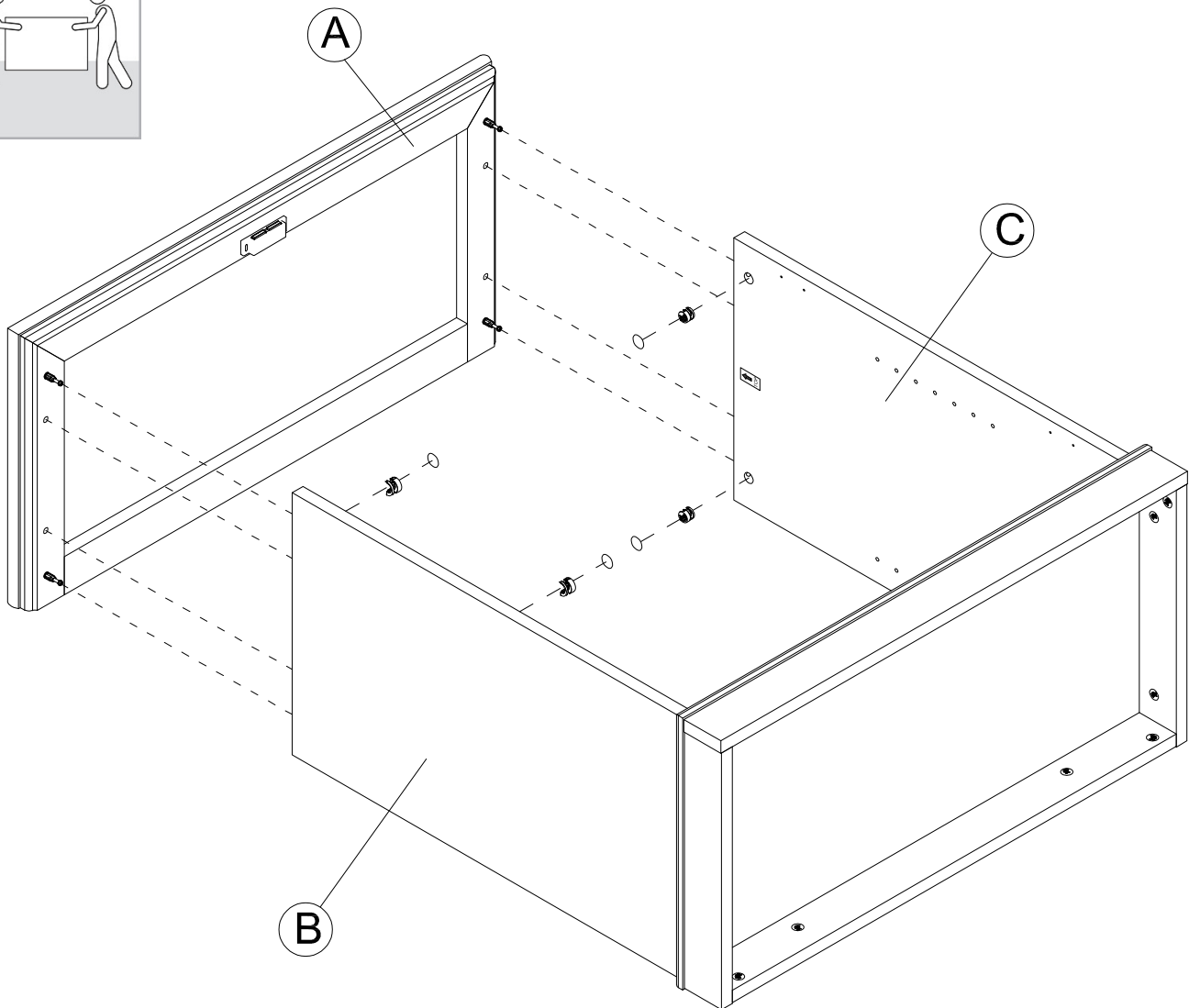
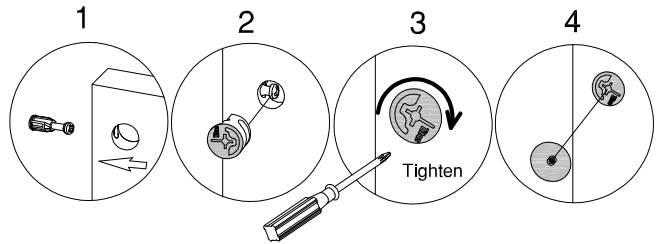

Have an assembly question or need a replacement part? Just call **1-800-950-4782**, we are here to help.

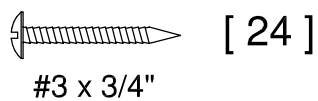

Center the back panel so that the back panel does not stick out past the edge of the unit.

Centrez le panneau arrière de manière à ce qu'il ne reste pas au-delà du bord de l'appareil.
Centre el panel posterior de modo que el panel posterior no se pegue más allá del borde de la unidad.

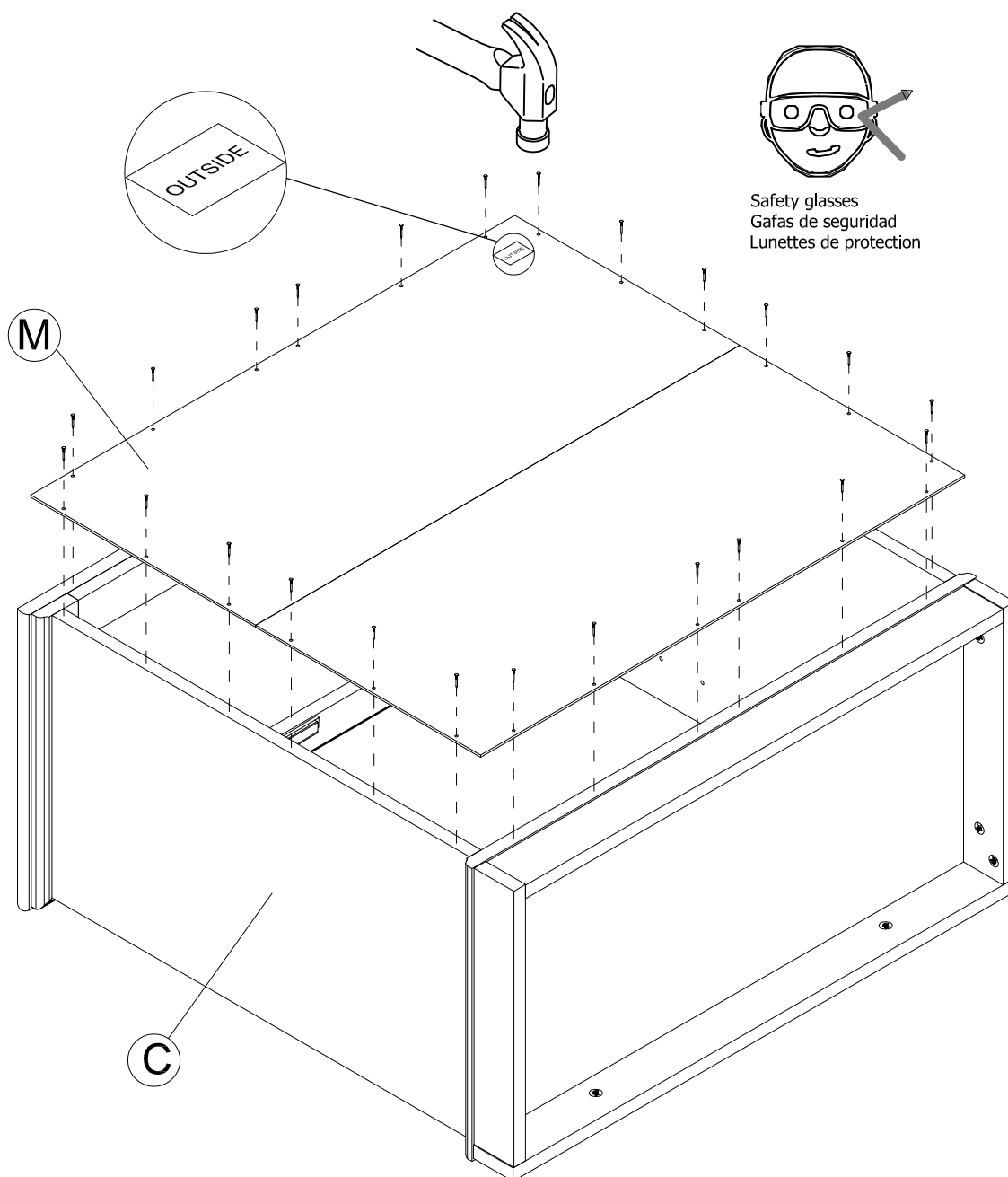

Have an assembly question or need a replacement part? Just call
1-800-950-4782, we are here to help.

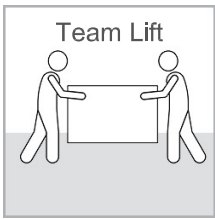

H158707

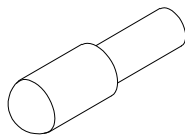

[4]

Shelf Pin

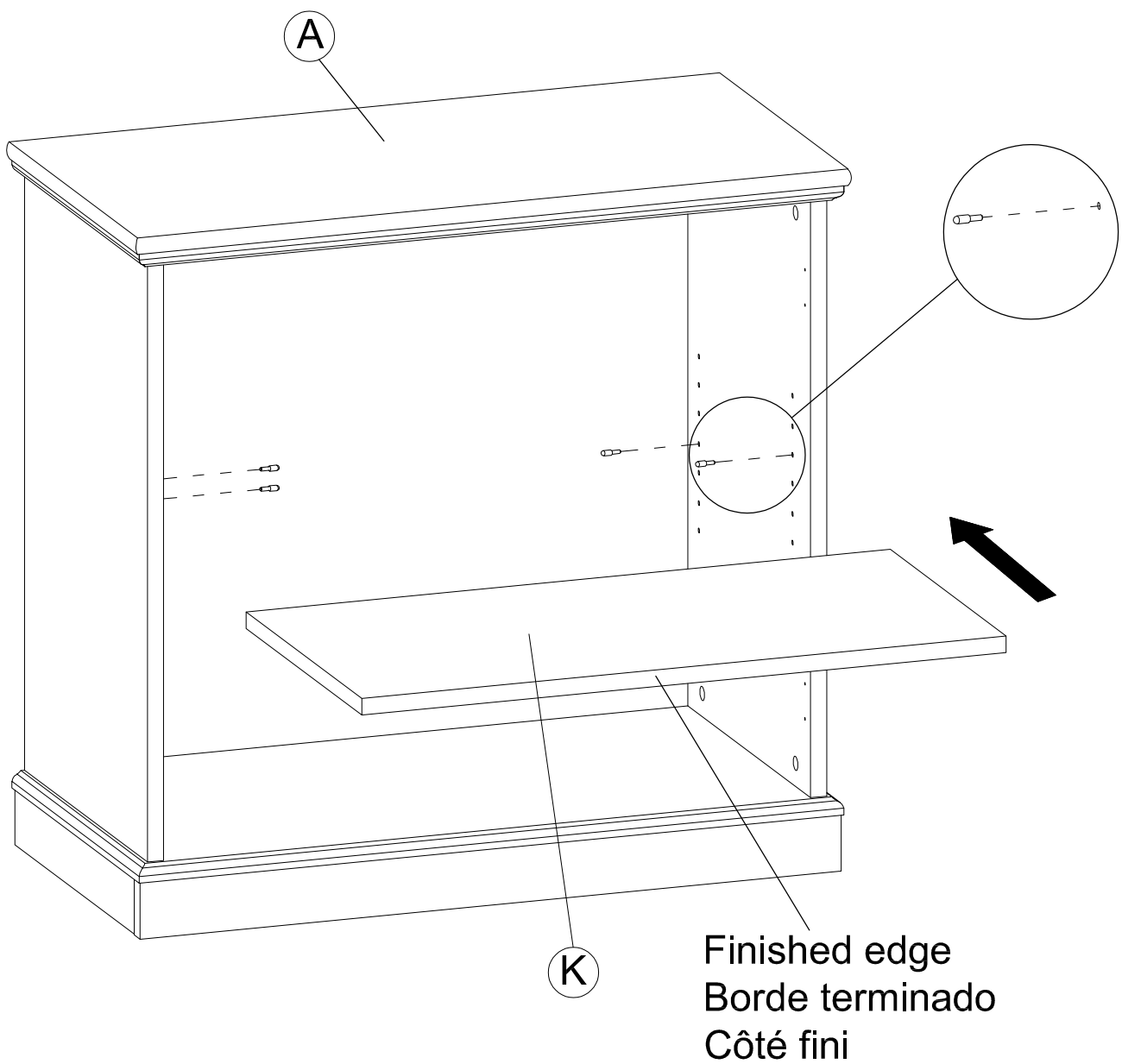

Have an assembly question or need a replacement part? Just call
1-800-950-4782, we are here to help.

STEP 15

Attach Doors

A212571

Scan QR Code to Watch Video on:



How to Adjust Door Hinges

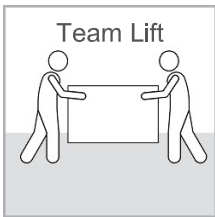

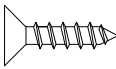
H211548  [8]
#8 x 5/8" BLACK

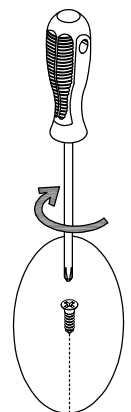
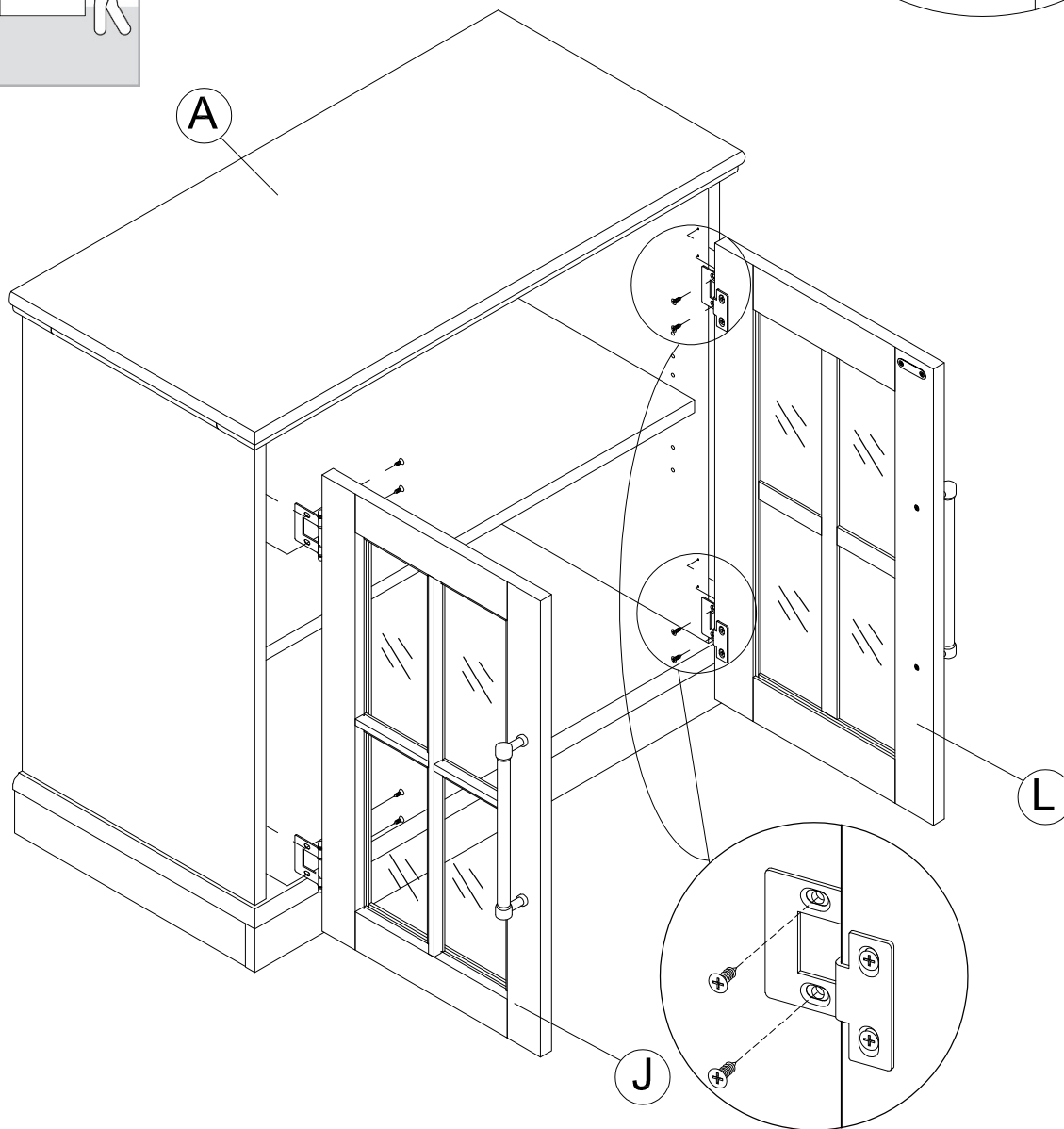
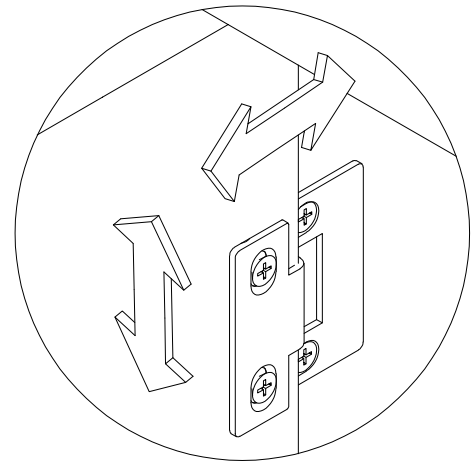

Have an assembly question or need a replacement part? Just call
1-800-950-4782, we are here to help.

Scan QR Code to
Watch Video on:



How to Clean
the Surface

**Gently clean surfaces with
a damp sponge eraser.**

MAXIMUM WEIGHT: 200 LBS (90.72 KG)
PESO MÁXIMO: 200 LIBRAS (90.72 KILOGRAMO)
POIDS MAXIMUM: 200 LIVRES (90.72 KILOGRAMME)

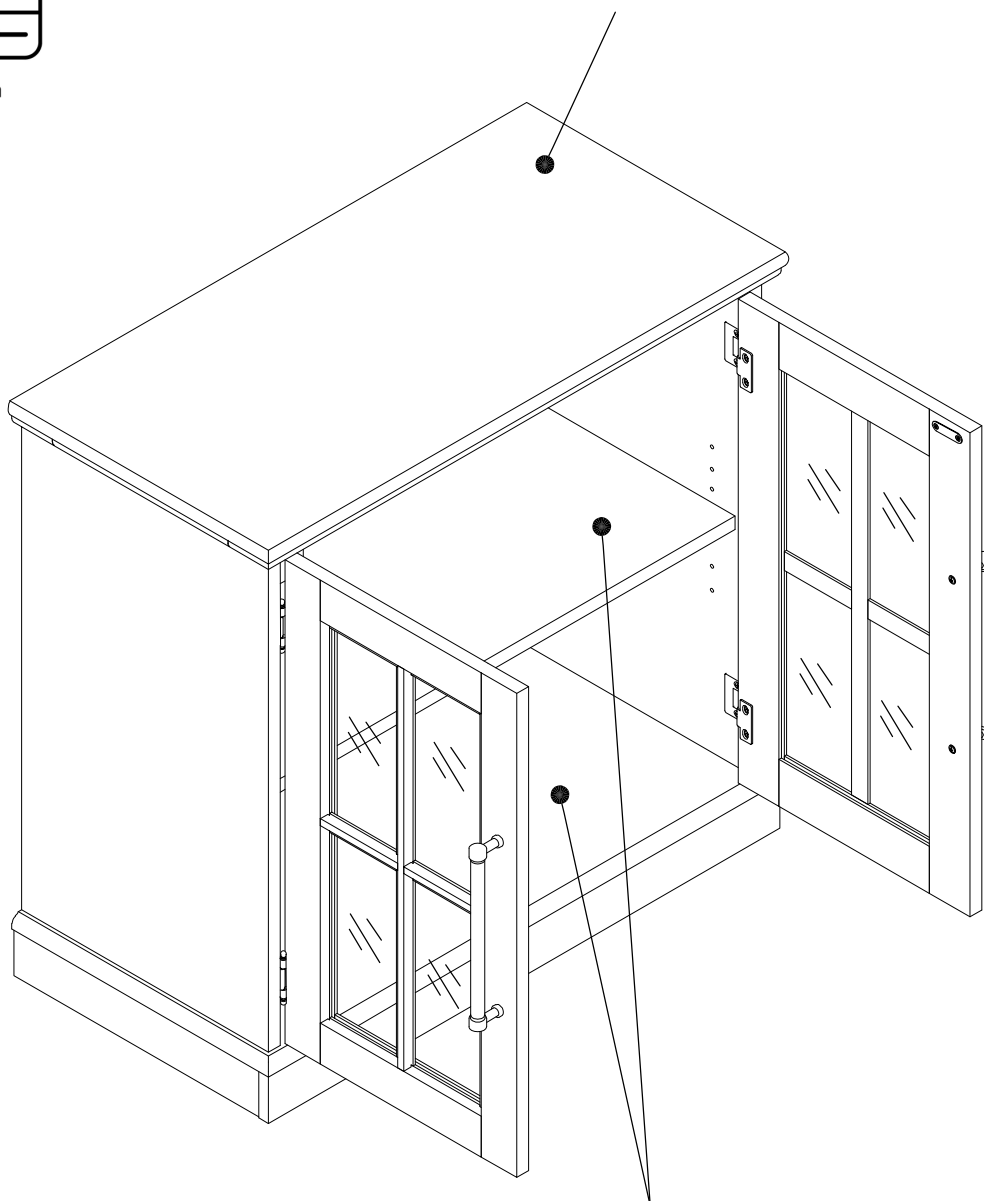

MAXIMUM WEIGHT: 50 LBS (22.68 KG)
PESO MÁXIMO: 50 LIBRAS (22.68 KILOGRAMO)
POIDS MAXIMUM: 50 LIVRES (22.68 KILOGRAMME)

**Congratulations! You are all done. If you have
any questions or concerns, please call.**

Have an assembly question or need a replacement part? Just call
1-800-950-4782, we are here to help.

WBV132WAS

A	[1]	S211334
B	[1]	W211335
C	[1]	W211336
D	[1]	W211337
E	[1]	W211338
F	[1]	W211339
G	[1]	W211340
H	[1]	W211341
J	[1]	S211342
K	[1]	W211343
L	[1]	S211556
M	[1]	W212595

H186067  [24]

#3 x 3/4" NICKEL

H192368  [8]

Cover Cap

WBV132V2R

A	[1]	S211345
B	[1]	W211346
C	[1]	W211347
D	[1]	W211348
E	[1]	W211349
F	[1]	W211350
G	[1]	W211351
H	[1]	W211352
J	[1]	S211353
K	[1]	W211354
L	[1]	S211567
M	[1]	W212596

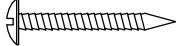
H34174  [24]
#3 x 3/4"

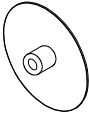
H160399  [8]
Cover Cap

WARRANTY INFORMATION/INFORMATIONS POUR LA GARANTIE/INFORMACIÓN DE GARANTÍA

BUSH FURNITURE'S WRITTEN WARRANTY TO YOU

In order to provide you with timely assistance, please thoroughly inspect your furniture for missing or defective parts immediately after opening the carton. To receive replacement or missing parts under this warranty, call our Consumer Service Department TOLL-FREE at 1-800-950-4782. Please have the Model, Part, and Lot Numbers found in the instruction manual available for your reference. You will also need your sales receipt or other proof of purchase. Replacement part(s) will be shipped to you at no charge with Bush Industries assuming all shipping and handling charges.

This Bush Furniture product is warranted to the original purchaser at the time of purchase and for a period of one year thereafter.

We warrant to you, the original purchaser, that our furniture and all its parts and components are free of defects in material or workmanship. "Defects," as used in this warranty, is defined as any imperfection which impairs the use of the furniture product.

Our warranty is expressly limited to the replacement of furniture parts and components. For one year after the date of purchase, Bush will replace any parts that are defective in material or workmanship.

This warranty applies under conditions of normal use. Our Bush Furniture products are not intended for outdoor use. This warranty does not cover: 1) defects caused by improper assembly or disassembly; 2) defects occurring after purchase due to product modification, intentional damage, accident, misuse, abuse, negligence or exposure to the elements; and 3) labor or assembly costs. 4) batteries are not included.

IMPLIED WARRANTIES, INCLUDING THE WARRANTY OF MERCHANTABILITY, SHALL NOT EXTEND BEYOND THE DURATION OF THE WRITTEN WARRANTY STATED ABOVE, AND IN NO EVENT SHALL BUSH BE LIABLE FOR INCIDENTAL OR CONSEQUENTIAL DAMAGES RESULTING FROM USE OF THE PRODUCT. Some states do not allow a limitation on how long an implied warranty lasts or the exclusion or limitation of incidental or consequential damages, so the above limitation and exclusion may not apply to you.

This warranty gives you specific legal rights. You may also have other rights that may vary from state to state.

VOTRE GARANTIE BUSH FURNITURE

Afin de vous assister rapidement, veuillez inspecter votre mobilier en détail immédiatement après l'ouverture du carton en cas de pièces manquantes ou défectueuses. Pour recevoir une pièce de rechange ou manquante couverte par cette garantie, appelez notre département de service clientèle GRATUITEMENT au 1-800-950-4782. Veuillez tenir à disposition les numéros de modèle, de pièce et de lot qui se trouvent dans le manuel d'instruction pour votre référence. Vous aurez également besoin de votre reçu ou d'une autre preuve d'achat. La (les) pièce(s) de rechange vous sera (seront) envoyée(s) sans frais, Bush Industries se chargeant de tous les frais d'expédition.

Tout le produit Bush Furniture est garanti à l'acheteur original à partir de la date d'achat pour une période d'un an.

Nous vous garantissons, à vous l'acheteur original, que notre mobilier et toutes ses pièces et composants sont sans défaut de matériau ou de fabrication. Le terme "défauts" utilisé dans cette garantie, est défini comme étant toutes les imperfections qui compromettent l'utilisation du meuble.

Notre garantie est expressément limitée au remplacement des pièces et des composants du mobilier. Pendant un an après la date d'achat, Bush remplacera toute pièce défectueuse dans le matériau ou sa fabrication.

Cette garantie d'applique sous des conditions d'utilisation normale. Nos produits ne sont pas destinés à être utilisés en plein air. Cette garantie ne couvre pas: 1) les défauts causés par un mauvais assemblage ou démontage, 2) les défauts ayant lieu après l'achat et dus à la modification du produit, des dommages intentionnels, des accidents, une mauvaise utilisation, un mauvais traitement, la négligence ou l'exposition aux éléments, et 3) les frais de main d'œuvre ou d'assemblage. 4) les piles ne sont pas incluses.

LES GARANTIES TACITES, Y COMPRIS LA GARANTIE DE QUALITE MARCHANDE, NE S'ETENDRONT PAS AU-DELA DE LA DUREE ECRITE CITEE CI-DESSUS, ET BUSH NE SERA EN AUCUN CAS RESPONSABLE DES DOMMAGES ACCESSOIRES OU INDIRECTS RESULTANT DE L'UTILISATION DU PRODUIT. Certains états ne permettent pas d'appliquer une limite à la durée de la garantie tacite, ni une exclusion ou limitation des dommages accessoires ou indirects; dans ce cas les limitations ou exclusion ci-dessus peuvent ne pas s'appliquer à vous.

Cette garantie vous donne des droits légaux spécifiques. Il se peut que vous ayez également d'autres droits qui peuvent varier d'un état à l'autre.

GARANTIA ESCRITA DE BUSH FURNITURE PARA USTED

Para brindarle asistencia oportuna, por favor, verifique detalladamente que a su mueble no le falte o tenga piezas defectuosas inmediatamente después de abrir la caja. Para recibir un reemplazo o la parte faltante bajo esta garantía, llame a nuestro Departamento de Servicio al Consumidor GRATIS al 1-800-950-4782. Sírvase traer los números de modelo, parte y lote que se encuentran en el manual de instrucciones disponible para su referencia. Además, necesitará el recibo de su compra u otra prueba de compra. La(s) pieza(s) de reemplazo le será(n) enviada(s) sin recargo por Bush Industries asumiendo los gastos de envío y manipuleo.

Todo mueble de Bush Furniture es garantizado al comprador original al momento de la compra y por un periodo de uno año en adelante.

Le garantizamos a usted, el comprador original, que nuestros muebles sus partes y componentes están libres de defectos en materiales o trabajo. "Defectos", según se usa en esta garantía, se define como una imperfección que perjudica el uso del producto mobiliario.

Nuestra garantía se limita expresamente al reemplazo de partes y componentes mobiliarios. Durante uno año después de la fecha de compra, Bush reemplazará cualquier parte defectuosa en material o trabajo.

Esta garantía se aplica bajo condiciones de uso normal. Nuestros productos de Bush Furniture no son para uso en exteriores. Esta garantía no cubre: 1) defectos causados por un ensamblaje o desensamblaje inadecuado; 2) defectos que ocurran después de la compra debido a modificación del producto, daño intencional, accidente, mal uso, abuso, negligencia o exposición a los elementos; y 3) costos de trabajo o ensamblaje. 4) las baterías no están incluidas.

LAS GARANTÍAS IMPLICADAS, INCLUYENDO LA GARANTÍA DE COMERCIABILIDAD, NO SE EXTENDERÁN MÁS ALLÁ DE LA DURACIÓN DE LA GARANTÍA ESCRITA MENCIONADA, Y EN NINGÚN CASO BUSH SERÁ RESPONSABLE POR DAÑOS INCIDENTALES O CONSIGUIENTES COMO RESULTADO DEL USO DEL PRODUCTO. Algunos estados no permiten una limitación sobre el tiempo de duración de la garantía implicada o la exclusión o limitación de daños incidentales o consiguientes, de manera que la limitación y exclusión mencionadas pueden no aplicarse para usted.

Esta garantía le otorga derechos legales específicos. Puede también tener otros derechos que pueden variar según los estados.

1-Year
Manufacturer's
Warranty

Register your product online:

Scan the QR Code or go to
[https://bushfurniture.com/
activate-warranty/](https://bushfurniture.com/activate-warranty/)



Assembly tips & how to videos:

Scan the QR Code to access our video
guides [https://bushfurniture.com/
help-faq/#assembling](https://bushfurniture.com/help-faq/#assembling)

