

PRODUCT SPECIFICATIONS

Quartz Classic® 25" x 18-1/2" x 5-1/2" Single Bowl Undermount ADA Sink with Perfect Drain®. Sink is molded with up to 80% natural quartz and high performance acrylic resins that are non-porous providing superior heat, scratch, fade and stain resistance. Naturally sound deadening and Rear Center drain placement.

Installation Type:	Undermount
Material:	Quartz
Special Features:	Perfect Drain
Finish:	Black (BK), Greystone (GS), Mocha (MC), White (WH)
Number of Bowls:	1
Sink Dimensions:	25" x 18-1/2" x 6-7/8"
Bowl 1 Dimensions:	22-5/16" x 16-7/16" x 5-1/2"
Drain Size:	3-5/8" (92mm)
Drain Location:	Rear Center
Minimum Cabinet Size:	30"
Mounting Hardware:	Part # 54300404 included
Template Included:	Yes
Cutout Template #:	0000001437

Template is available for download at [elkay.com](#). CAD software will be required to open the template.

Perfect Drain: Seamlessly molded collar eliminates the gap between a traditional drain and the sink for a more sanitary and gap free installation. Select garbage disposers can be installed on either sink bowl for user convenience. Please see our Garbage Disposer Compatibility Guide.

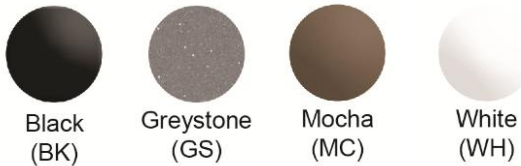

Included with Product: One LKPDQ1CR Perfect Drain and strainer.

A Century of Tradition and Quality. For more than 100 years, Elkay has been making innovative products and providing exceptional customer care. We take pride in offering plumbing products that make life easier, inspire change and leave the world a better place.



Product Compliance: CSA B45.5/IAPMO Z124
Accessory: ASME A112.18.2/CSA B125.2



Sinks are listed by IAPMO® as meeting the applicable requirements of the Uniform Plumbing Code®, International Plumbing Code®, and National Plumbing Code of Canada.

Complies with ADA & ICC A117.1 accessibility requirements when installed according to the requirements outlined in these standards.

- [Clean and Care Manual \(PDF\)](#)
- [Installation Instructions \(PDF\) - 1000005238](#)
- [Installation Instructions \(PDF\) - 1000004396](#)
- [Installation Instructions \(PDF\) - 1000003889 perfect-drain](#)
- [Installation Instructions \(PDF\) - Garbage Disposer Compatibility Guide](#)
- [Warranty \(PDF\)](#)

PART: _____ QTY: _____

PROJECT: _____

CONTACT: _____

DATE: _____

NOTES: _____

APPROVAL: _____

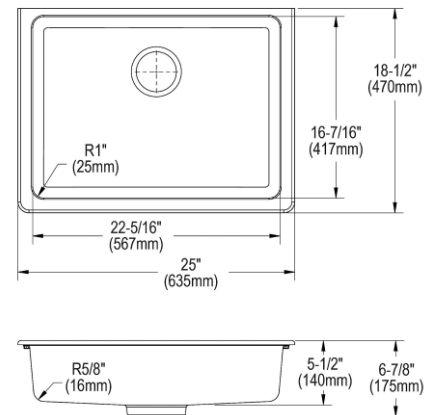

In keeping with our policy of continuing product improvement, Elkay reserves the right to change product specifications without notice. Please visit [elkay.com](#) for the most current version of Elkay product specification sheets. This specification describes an Elkay product with design, quality, and functional benefits to the user. When making a comparison of other producers' offerings, be certain these features are not overlooked. Latest version of the spec sheet available: https://www.elkayfiles.com/spec-sheets/ELGUAD2519PD_spec.pdf

Installation Profile:

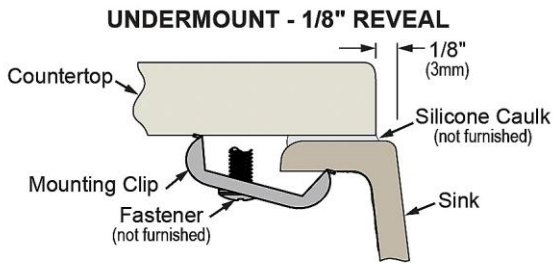

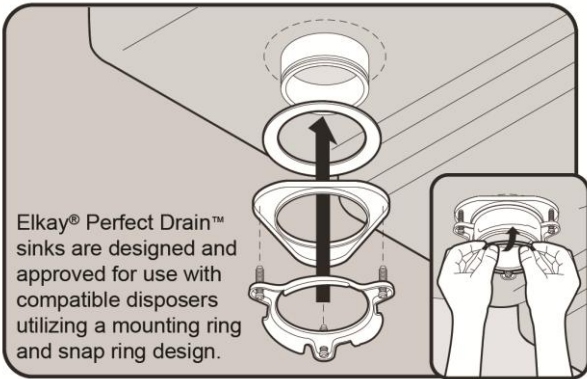
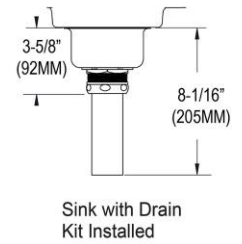

Designed to affix to the underside of any solid surface countertop.



Elkay® Perfect Drain™ sinks are designed and approved for use with compatible disposers utilizing a mounting ring and snap ring design.

Optional Accessories		
LKCBEG2217HW	Hardwood 23-1/4" x 17-3/8" x 1" Cutting Board Spec Sheet (PDF)	
LKPDO1LS	Perfect Drain® Fitting Type 304 Stainless Steel Body and Strainer Lustrous Steel Spec Sheet (PDF)	
LKPDQS	Quartz Perfect Drain® 3-1/2" Removable Polymer Basket Strainer and Rubber Stopper Spec Sheet (PDF)	
LKPDQD1	Quartz Perfect Drain® 3-1/2" Polymer Disposer Flange with Removable Basket Strainer and Rubber Stopper Spec Sheet (PDF)	
LKGT1042	Elkay Gourmet Single Hole Bar Faucet Pull-out Spray and Lever Handle Spec Sheet (PDF)	

In keeping with our policy of continuing product improvement, Elkay reserves the right to change product specifications without notice. Please visit elkay.com for the most current version of Elkay product specification sheets. This specification describes an Elkay product with design, quality, and functional benefits to the user. When making a comparison of other producers' offerings, be certain these features are not overlooked. Latest version of the spec sheet available: https://www.elkayfiles.com/spec-sheets/ELGUAD2519PD_spec.pdf

<p>LKQD35</p>	<p>Polymer 3-1/2" Disposer Flange with Removable Basket Strainer and Rubber Stopper Spec Sheet (PDF)</p>	
<p>LKQS35</p>	<p>Polymer 3-1/2" Drain Fitting with Removable Basket Strainer and Rubber Stopper Spec Sheet (PDF)</p>	

In keeping with our policy of continuing product improvement, Elkay reserves the right to change product specifications without notice. Please visit elkay.com for the most current version of Elkay product specification sheets. This specification describes an Elkay product with design, quality, and functional benefits to the user. When making a comparison of other producers' offerings, be certain these features are not overlooked. Latest version of the spec sheet available: https://www.elkayfiles.com/spec-sheets/ELGUAD2519PD_spec.pdf