



BCPA12

USER MANUAL

BLUETOOTH® | 340 WATTS | SINGLE-DIN
MP3-COMPATIBLE DIGITAL MEDIA AM/FM RECEIVER
Apple CarPlay® Android Auto™ (Wired)
FEATURING 12" (305 mm) CAPACITIVE TOUCHSCREEN
AND MULTICOLOR ILLUMINATION OPTIONS





Thank you for choosing BOSS Audio Systems!

Sign up for BOSS Audio Systems News and Promos by visiting us on the web at www.bossaudio.com.

Be part of our community! Join us by signing up on the web at www.bossinsiders.com

<i>IMPORTANT! Complete the information below and keep for your records.</i>	
Model	
Serial Number	
Date of Purchase	
<i>Note: Serial number is located on the packaging and the top of the product chassis.</i>	

Table of Contents

Important Information	4
About this Manual.....	4
Operation Warnings	4
Installation Warnings	5
Notice	5
Basic Operation	6
What Comes in the Box	6
Control Panel.....	7
Unit Installation.....	8
Use and Care for the Touchscreen.....	11
First Time Setup	12
Home Menu Description	13
FM/AM Radio	14
Radio Home Screen	14
Tune to a Radio Station	14
Auto Store Radio Stations	14
Preset a Radio Station	14
Search via Frequency Input	14
FM Local and Distant.....	14
FM Stereo and Mono.....	14

Apple CarPlay	15
Apple CarPlay Introduction	15
Connect your iPhone	15
Arrange your CarPlay Apps.....	16
Disable CarPlay Apps	16

Android Auto	17
Android Auto Introduction	17
Connect your Android Device	17

Bluetooth	18
First Time Connection.....	18
Audio Streaming.....	18
Make a Call.....	19
Operation During a Call	19
Sync Phonebook and History.....	19
Search a Contact.....	19
Browse Call History	19
View Connection Status.....	19
Voice Assistant (Push-To-Talk)	19

USB	20
USB Playback.....	20
Audio/Video/Photo Play Switching	20
Audio Playback.....	20
Video Playback	20
Photo Playback.....	20

Other External Devices	21
Audio/Video Input	21
Playback.....	21
Audio Input.....	21
Video Input	21
Manual Camera Trigger.....	21
Automatic Camera Trigger	21

Sound Settings	22
Sound Mode and Equalizer Setting	22
Volume Balance Setting	22
Crossover Frequency Setting	22
Time Alignment Setting.....	22

Table of Contents

General Settings 23

System Tone and Shutdown Delay	23
Set Date and Time Manually.....	23
Set Date and Time Automatically	23
Language Setting.....	23
Steering Wheel Control Retention	23

Audio Settings 24

Loudness and Sound Effect Setting	24
Startup Volume Setting.....	24
Initial Volume Setting for Other Sources	24
Customization of a Source Volume.....	24

Display Settings 25

Wallpaper Setting.....	25
Screen Setting	25
Automatic Dimming Control	25
Panel Button Light Setting	25

Bluetooth Settings 25

Radio Settings 26

Radio Region Selecting	26
RDS/RBDS Activation	26
RDS/RBDS Information Display	26
RDS/RBDS Traffic Announcement	26
RDS/RBDS Alternative Frequency.....	26

Camera Settings 26

Camera Trigger Control.....	26
Parking Assist Guidelines Setting.....	27

System Information 27

Firmware Version Information	27
Firmware Update	27
Resetting the Unit.....	27

Connections 28

Power and SWC Wiring.....	28
Speaker Wiring	29
Parking Brake Wiring	30
AV/Radio.....	31
Mic/Camera/CarPlay/Android Auto.....	32
Hands-Free Mic Installation	33

Troubleshooting 34

Specifications 35

Important Information

About this Manual

To understand how to properly use your new BOSS Audio Systems product, it is recommended to read this user manual in its entirety, and keep it in a safe place for future reference.

This manual uses illustrations to show you how to use this product safely and alert you to potential dangers resulting from improper connections and operation. It is important to fully understand the meaning of each one of these illustrations in order to use this manual and system properly.



The **WARNING** illustration denotes very important instructions. Failure to follow them can result in damage to equipment, serious injury or death.



The **CAUTION** illustration denotes important instructions. Failure to follow them can result in injury or material property damage.



The **IMPORTANT NOTE** illustration denotes important instructions for product features and limitations. Failure to follow them will result in product misuse and/or unexpected behavior.

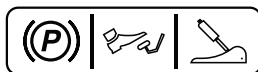

The **PARKING BRAKE** illustration denotes features that can only be used with vehicle not in motion and parking brake engaged. Failure to follow them will result in product misuse and/or unexpected behavior.

Operation Warnings



OPERATION OF THIS PRODUCT WHILE DRIVING IS DANGEROUS.

Users should come to a complete stop and in a safe location before using any feature that requires extended periods of time.

PAY ATTENTION TO ROAD CONDITIONS.

Avoid operating product under dangerous road conditions and abide by regulations over information contained on the map display. Follow traffic restrictions and circumstances while driving.

OPERATE AT SAFE VOLUME LEVELS.

Excessive volume levels may obstruct sounds such as emergency vehicle sirens or road warning signals; can be dangerous and may result in an accident. Listening at high volume levels can also cause hearing damage.

DO NOT WATCH VIDEO WHILE DRIVING.

Watching video content may distract the driver from looking ahead of the vehicle and can potentially cause an accident.

Important Information

Installation Warnings

CERTIFIED PROFESSIONAL INSTALLATION.

Installation and service repair of this product by anyone without professional training and experience in consumer electronics and mobile vehicle accessories may be dangerous and result in electric shock, injury or other hazards.

DISCONNECT BATTERY.

To avoid potential shorts in the electrical system, be sure to disconnect the **NEGATIVE (-)** terminal cable before beginning this product installation. Failure to do so may result in electric shock, fire, damage to product and/or property damage.

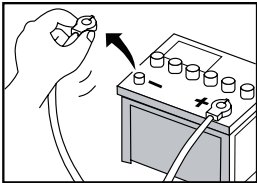

DO NOT DISASSEMBLE OR ALTER PRODUCT.

Disassembly of product may result in an accident, fire or electric shock.

REPLACE FUSE WITH THE CORRECT RATING.

Failure to do so may result in fire or property damage.

PARKING BRAKE INSTALLATION WIRING.

Installing this product incorrectly may enable the user to watch video while driving. This may cause distraction, preventing the driver to focus on the road and potentially cause an accident. The driver and passengers can be severely injured.



Notice



Apple CarPlay is a trademark of Apple Inc.

iPhone® is a trademark of Apple Inc., registered in the U.S. and other countries.

Use of the Apple CarPlay logo means that this user interface meets Apple performance standards.

Apple is not responsible for the operation of this device or its compliance with safety and regulatory standards.

BOSS Audio Systems is not affiliated with Apple Inc.



Android Auto is a trademark of Google LLC.



The Bluetooth® word mark and logos are registered trademarks owned by Bluetooth SIG, Inc. and any use of such marks by BOSS Audio Systems are under license. Other trademarks and trade names are those of their respective owners.

Basic Operation

What Comes in the Box

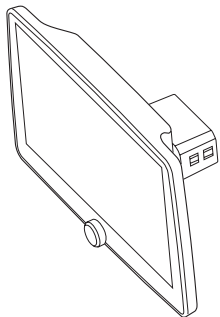

Display

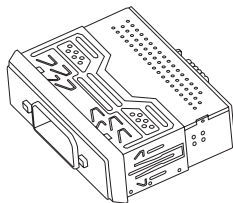

Main Unit

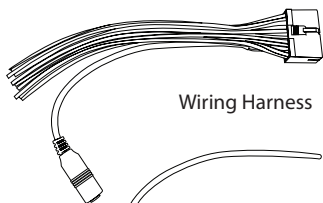

Wiring Harness

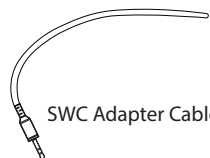

SWC Adapter Cable

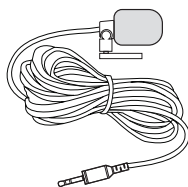

Microphone with 3.5mm Plug
and Sticky Base

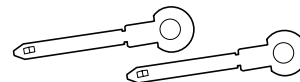

2x Release Keys

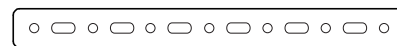

1x Mounting Strap



1x Hex Bolt



1x Hex Nut



2x Plain Washers



1x Tapping Screw



1x Spring Washer



1x Rubber Grommet

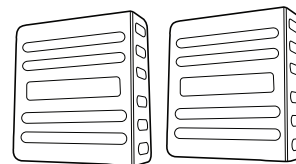

2x Side Brackets



8x Screws

Basic Operation

Control Panel

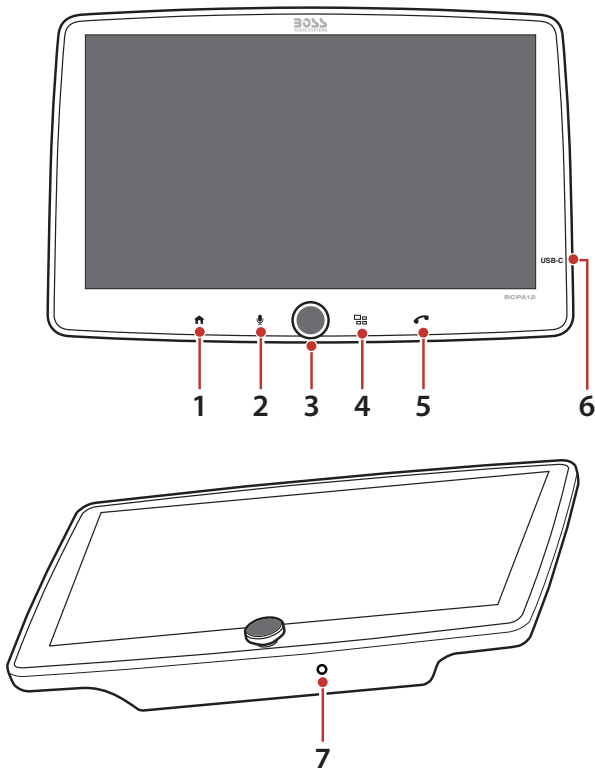

1 Home button

- Touch to switch between the home menu and the last selected source.
- When powered on, touch and hold to turn the screen off.

2 Voice assistant (Push-To-Talk)

Touch to activate voice assistant.

Enable Apple CarPlay, Android Auto or Bluetooth connection to use voice assistant.

3 Power/Mute button

- Press to power on the unit; press and hold to power off the unit.
- Rotate to adjust volume.
- Press to mute or restore the volume when powered on.

4 Mode button

Touch to select a source (Radio, USB, CarPlay/Android Auto, Bluetooth, AUX/AV input).

5 Phone button

Touch to answer a phone call, or dial a Bluetooth phone call.

6 USB-C port (1.5A charging port)

Audio, video or picture input from a USB flash drive.

If needed, use a USB-C adapter (not included) to fit your USB flash drive into the USB-C port.

7 Reset button

Use a needle or pin to press the button. Reset the unit if the unit fails to function normally.

TIP:

When the unit is powered off, touch the screen to turn on or off time/date display.

Basic Operation

Unit Installation



WARNING

See the section "Installation Warnings". (P.5)

Single DIN Opening Installation

This section explains the installation if your vehicle has a single DIN opening (2" x 7").

1. Remove the trim plate from the front panel.
Use a screwdriver to pry open the trim plate.
2. Remove the mounting sleeve from the unit.
Insert the two supplied release keys into the locking tabs on both sides of the unit, then pull the mounting sleeve off.

Then secure the mounting sleeve into the dash opening. Bend the tabs on the mounting sleeve to lock the sleeve into place.

3. Insert the unit into the dash opening/
mounting sleeve.
4. Secure the supplied metal strap to the rear of the unit to provide extra fastening (if your car does not have a rear bracket to fix the unit).
Use the supplied hex bolt, hex nut (a), spring washer (b), plain washer (c), tapping screw to fix the metal strap.
Replace the trim plate after the installation.

Before you mount the unit into the dash, complete the wiring connection (P. 28 to 33).

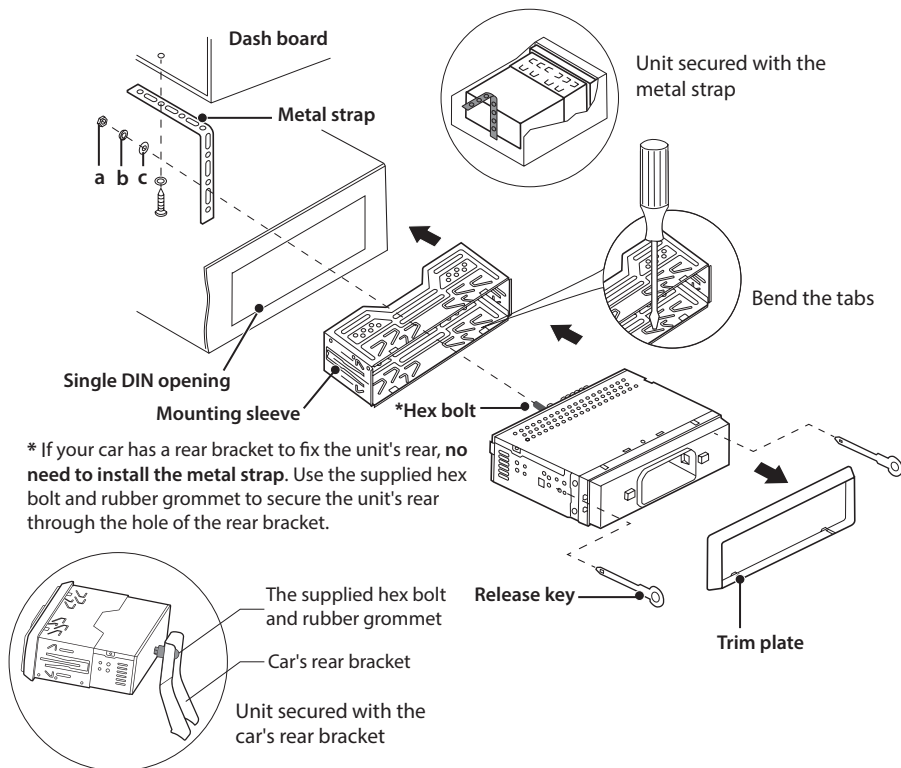

Basic Operation

Unit Installation

Double DIN Opening Installation

This section explains the installation if your vehicle has a double DIN opening (4" x 7").

1. Remove the trim plate and the mounting sleeve from the unit, as described in the section "Single DIN Opening Installation".
2. Using two supplied side brackets and screws, fasten the unit to the double DIN opening. Replace the trim plate after the installation.

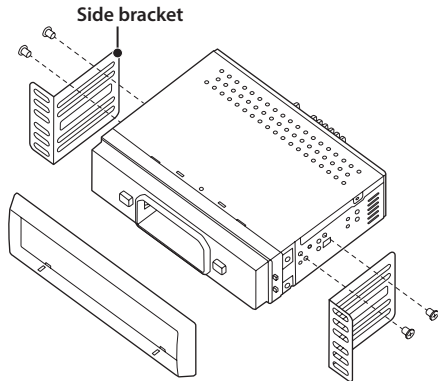

Attach the Display

As illustrated below, insert the supplied display into the head unit until it clicks.

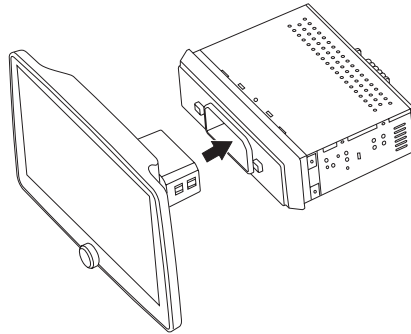

Detach the Display

As illustrated below, hold down two release buttons simultaneously to unlock the display then pull the display out.

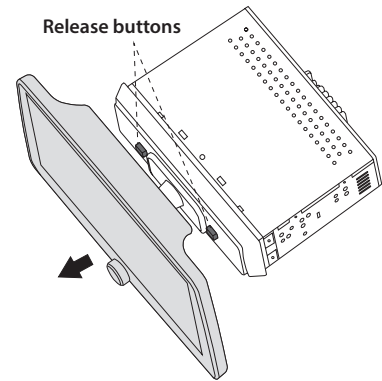

Basic Operation

Unit Installation

Adjust positioning of the Display

When attaching the display to the unit, you can adjust the display angle so that your view is clear and it does not impair your driving.

Tilt the Display Up and Down

The display can be vertically tilted by 25 degrees.

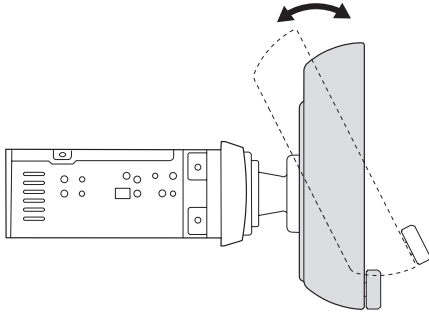

Tilt the Display Left and Right

The display can be horizontally tilted by 15 degrees.

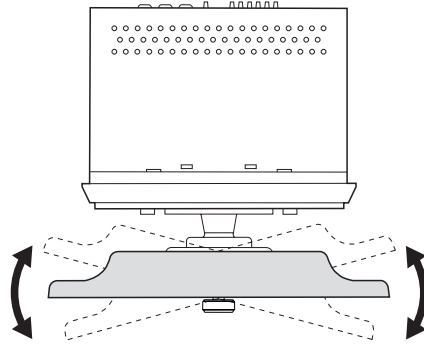

Adjust the Display Height

Hold the display then slide it up or down to adjust the height.

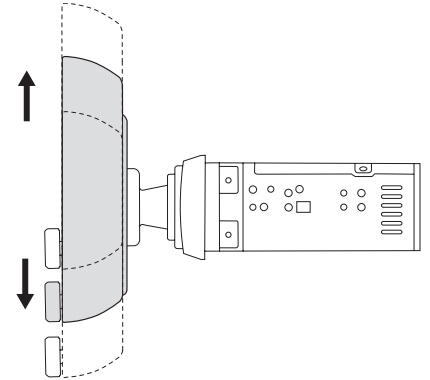

Basic Operation

Use and Care for the Touchscreen

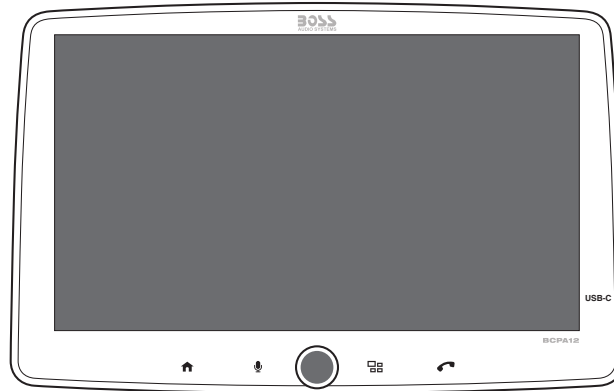

Use

This head unit utilizes a Capacitive Touchscreen, the same type that is used on high-end mobile devices. It should be used for and cared for like that type of device. As with all capacitive type technology, if your fingers are wet or sweaty, it will not function properly.

Do not allow any sharp objects to come in contact with the screen.

Care and Cleaning

To clean the screen, use a dry or slightly damp micro fiber type cloth to clean. Do not use ammonia, window cleaner, or any other type of household chemicals to clean the screen. Abrasives should never be used.

Best to clean the screen when the unit is powered off, cool and not in direct sunlight.

Basic Operation

First Time Setup

When you turn on the unit for the first time or reset the unit, the initial setup page will appear.

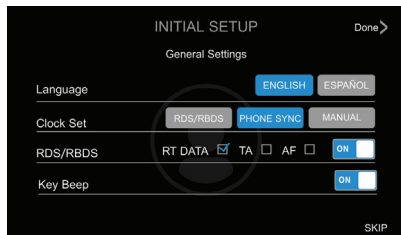

Set Language

[Language]: Select English or Spanish as a display language for menu.

You can set language later. From the home menu, select **[SETTINGS]** > **[General]** > **[Language]**.

Set Clock

[RDS/RBDS]: Automatically set date and time from RDS/RBDS broadcast.

[PHONE SYNC]: Automatically set date and time from Apple CarPlay.

[MANUAL]: Set date and time manually.

Set date and time manually

Select **[MANUAL]** to access time, date and time zone settings.

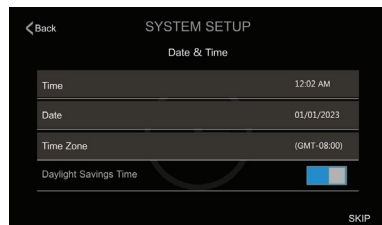

[Time]: Access time setting screen. Swipe up and down to set hours, minutes, and AM/PM or 24 hour format respectively.

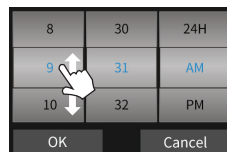

[Date]: Access date setting screen. Swipe up and down to set year, month, and day respectively.

[Time Zone]: Select a time zone in your current location.

[Daylight Savings Time]: Enable to adjust daylight saving time automatically.

You can set date and time later. From the home menu, select **[SETTINGS]** > **[General]** > **[Date & Time]**.

Set RDS/RBDS Radio

The RDS/RBDS (Radio Broadcast Data System) enables FM stations to send additional information when broadcasting radio.

[RT DATA]: Enable/disable display of RDS/RBDS information (i.e. station name, program type or other dynamic/static message).

[TA]: Enable/disable traffic announcement (TA).

[AF]: Enable/disable switching to alternative frequency (AF) for the same tuning program.

When enabled, the unit will automatically locate the same tuning program on other stations and select the strongest signal of those being broadcast.

[ON]/[OFF]: Enable/disable RDS/RBDS features.

You can set RDS/RBDS later. From the home menu, select **[SETTINGS]** > **[Radio]** > **[RDS/RBDS]**.

Enable/Disable System Tone

[Key Beep]: When disabled, sound will not be made when touching a button or option on the screen.

Basic Operation

Home Menu Description

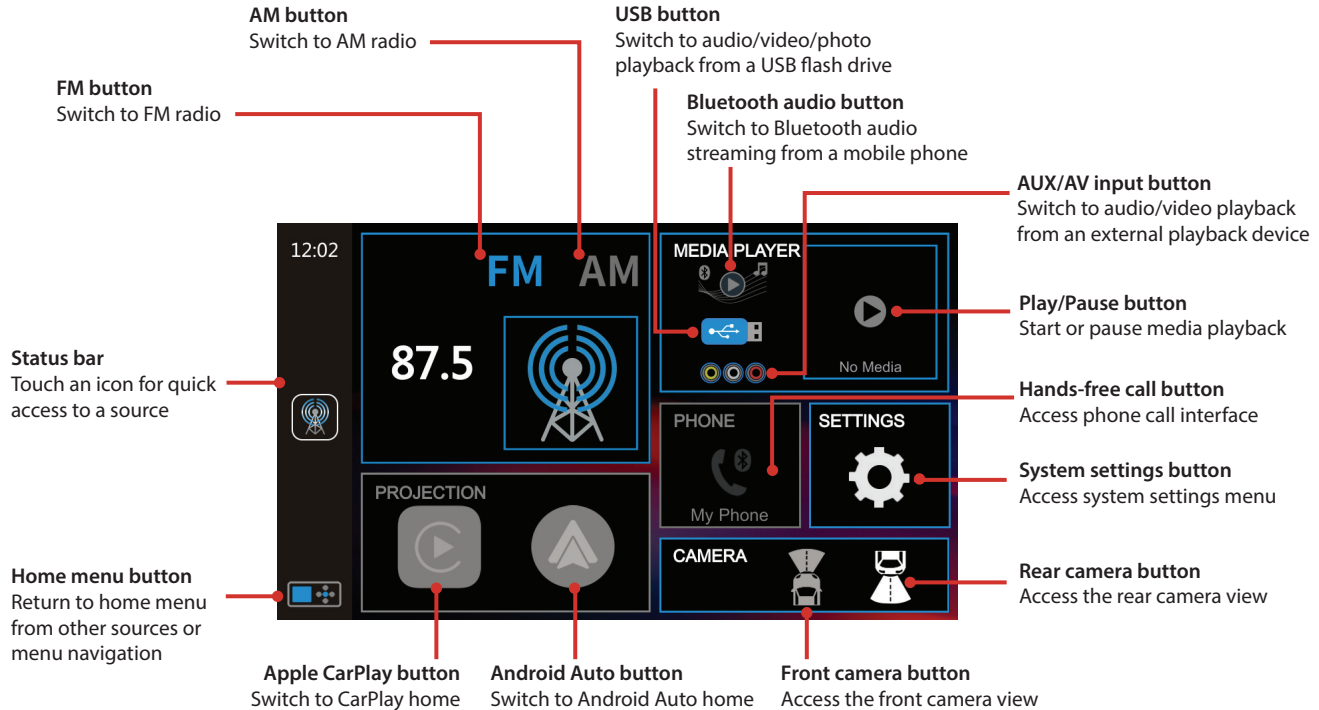

FM/AM Radio

Using FM/AM

Radio Home Screen

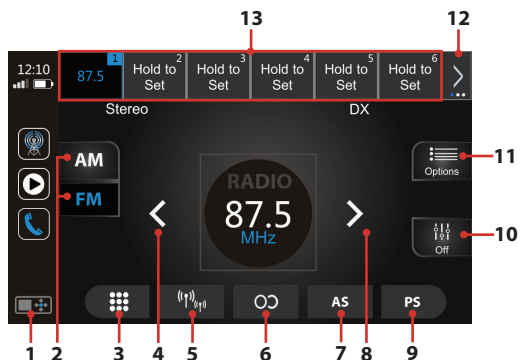

- 1 Return to the home menu.
- 2 Switch between AM and FM.
- 3 Search for a radio station by frequency input.
- 4 Touch to tune to a station in auto seek mode. Touch and hold to switch between auto and manual seek mode.
- 5 Switch between local and distant station reception (only applicable to FM).
- 6 Switch between Stereo and Mono reception (only applicable to FM).
- 7 AS (Auto Scan): Search and store FM or AM stations.

- 8 Touch to tune to a station in auto seek mode. Touch and hold to switch between auto and manual seek mode.
- 9 PS (Preset Scan): Preview each stored station for five seconds. Touch the button again to stop the scan.
- 10 Select a preset sound mode.
- 11 Access radio settings (e.g. RDS/RBDS options). (P.26)
- 12 Access more stored stations.
- 13 Select a preset station. Touch and hold to save the current station as a preset.

Tune to a Radio Station

In auto seek mode, touch briefly < or > to tune to a station.

Touch and hold < or > to switch between auto and manual seek mode.

To fine tune a station, in manual seek mode, touch < or > to change frequencies in steps.

Auto Store Radio Stations

Touch [AS] on the display. Up to 18 FM or 12 AM stations will be stored.

Preset a Radio Station

Touch and hold a preset number in the top bar of the display. The current station will be stored as a preset.

Search via Frequency Input

Touch  to display a numeric keypad. Input a station frequency to find your station.

FM Local and Distant

Touch  to select local or distant station reception. "LOC" display indicates local reception, "DX" display for distant reception.

Select "DX" when most FM stations are weak (e.g. in the countryside). Stations with both strong and weak signals will be received.

Select "LOC" when most FM stations are strong enough (e.g. in urban areas). Only the stations with strong signal will be received.

FM Stereo and Mono

Touch  to select Stereo or Mono reception.

When FM signal is weak, select Mono to improve sound quality (stereo will be lost).

Apple CarPlay

Using CarPlay

Apple CarPlay Introduction

CarPlay provides a smarter, safer way to use your iPhone while driving. The apps on your iPhone can be loaded and displayed on the screen of this unit. Thus, you can navigate, call, control you music and so more with hands-free control on your mobile phone.

For more details about Apple CarPlay, visit <http://www.apple.com/ios/carplay>.

Compatible iPhones

CarPlay works with iPhone 5 and all the way up to the most recent versions.

IMPORTANT NOTE

When CarPlay is enabled, hands-free calls and streaming through Bluetooth is not available through Bluetooth.

You can make hands-free calls and streaming through the CarPlay app.

Connect your iPhone

USB cable connection will enable CarPlay feature. iPhone pairing is not needed.

1. Connect your iPhone to the "Apple CarPlay" USB port, using an Apple-certified lightning cable with factory length or shorter (not included). (P.32)

The apps from the iPhone will be loaded onto the unit.

Touch the **Apple CarPlay** icon on the unit's home menu to access the loaded apps for navigation, phone and music, etc.



- 1 **Menu bar:** Touch an app icon for quick access.
- 2 **CarPlay home button:** Return to the CarPlay home screen.
- 3 **Unit's home button:** Exit the CarPlay screen and return to the unit's home menu.
- 4 Apps loaded from the iPhone.

Use Voice Assistant

Touch  on the unit's front panel to activate voice assistant, then speak your command.

Make sure the supplied external microphone is connected to the unit. (P.32)

Switch to CarPlay from Other Source

Touch once or more  on the unit's front panel.

Change Menu Bar Position

For driving seat convenience, you can change the menu bar from the left side to the right side of the screen and vice versa.

1. From the unit's home menu, select [SETTINGS] > [General] > [Right Hand Drive].
2. Enable or disable the option to change the position of the menu bar. Restart the unit to make the change effective.



For your safety, park your vehicle in a safe place and engage the parking brake when you make any setup which requires extended time.

Apple CarPlay

Using CarPlay

Arrange your CarPlay Apps

You can add, remove, or arrange the order of the apps on the CarPlay screen of the unit.

1. On your iPhone, go to **Settings > General > CarPlay**, select this unit's name from the device list (shown below). Then select **Customize** to access CarPlay apps.

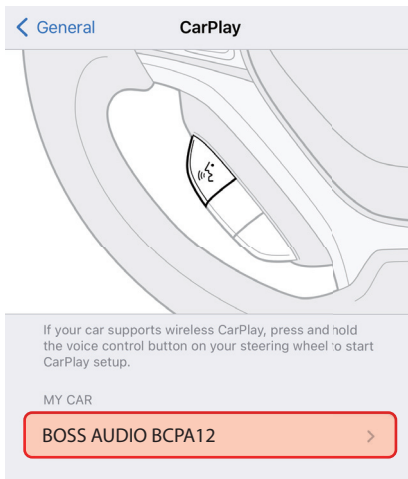

2. Touch and drag an app (☰) to change the order of the app.

Touch **−** or **+** to remove and add apps,

Only apps with **−** or **+** can be removed from CarPlay or added in CarPlay.

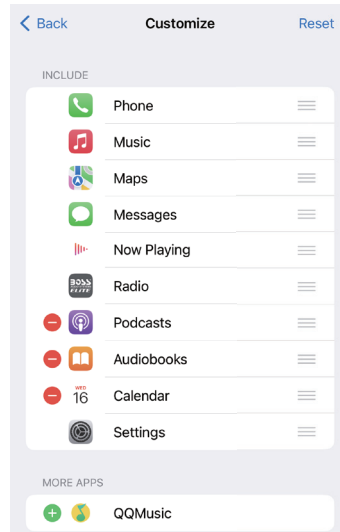

Disable CarPlay Apps

You can disable all CarPlay apps to restrict CarPlay use on this unit.

On your iPhone, go to **Settings > Screen Time > Contents & Privacy Restrictions > Allowed Apps > CarPlay**.

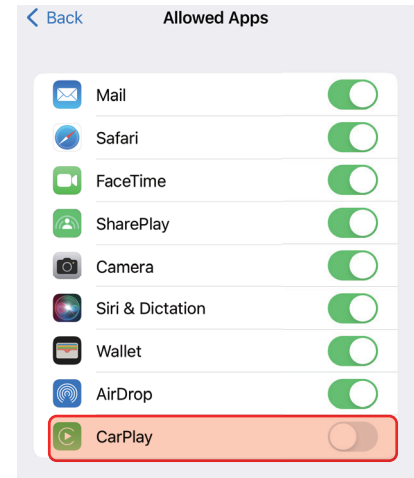

Android Auto

Using Android Auto

Android Auto Introduction

Android Auto allows the apps on your Android phone to be loaded and displayed on the screen of this unit. Thus, you can navigate, call, control you music and so more with hands-free control on your mobile phone.

For more details about Android Auto, visit <http://www.android.com/auto>.

Compatible Android Phones

Android Auto works with phones running Android 6.0 and later.

Android Auto App

- Phones with Android 9.0 and earlier needs Android Auto app downloaded from Google Play Store.
- Phones with Android 10 and above do not need to download Android Auto app.

IMPORTANT NOTE

When Android Auto is enabled, hands-free calls and streaming through Bluetooth is disabled.

You can make hands-free calls and streaming through the Android Auto app.

Connect your Android Device

USB cable connection will enable Android Auto feature. Bluetooth pairing is automatically between the unit and your phone.

1. Connect your Android phone to the "Android Auto" USB port, using a certified cable with factory length or shorter (not included). (P.32)

The apps from the Android device will be loaded onto the unit.

Touch the **Android Auto** icon on the unit's home menu to access the loaded apps for navigation, phone and music, etc.



- 1 **Menu bar:** Touch an app icon for quick access.
- 2 **Android Auto Home button:** Return to the Android Auto home screen.
- 3 **Unit's Home button:** Exit the Android Auto screen and return to the unit's home menu.
- 4 **Apps loaded from the Android Phone.**

Use Voice Assistant

Touch  on the unit's front panel to activate voice assistant, then speak your command.

Make sure the supplied external microphone is connected to the unit. (P.32)

Switch to Android Auto from Other Source

Touch once or more  on the unit's front panel.



For your safety, park your vehicle in a safe place and engage the parking brake when you make any setup which requires extended time.

Bluetooth

Connection

IMPORTANT NOTE

Bluetooth on the unit is enabled only when CarPlay or Android Auto is not connected. Make sure your CarPlay or Android Auto is disconnected for Bluetooth use.

Compatibility with all mobile devices is not guaranteed.

First Time Connection

When you connect your Bluetooth device to this unit for the first time, pair the device via either of the options below.

Make sure Bluetooth on your device is enabled.

Option 1

On your mobile device, go to **Settings** > **Bluetooth**, and select this unit's name (**BOSS AUDIO BCPA12**) to pair.

Option 2

From the unit's home menu, touch .

The Bluetooth interface is displayed.

Touch **[Device]** tab, then **[Scan]** to search for available Bluetooth devices, and select your Bluetooth device name to pair.



IMPORTANT NOTE

When prompted during pairing, select **"Allow"** on your mobile phone so that your phonebook and call history can be downloaded and displayed on the screen of this unit.

Bluetooth Reconnection

After your mobile device is paired with the unit, the two will automatically reconnect each time they are turned on.



For your safety, park your vehicle in a safe place and engage the parking brake when you make any setup which requires extended time.

Streaming





Audio Streaming

Before you can stream audio from your mobile device to this unit, make sure Bluetooth connection is made.

1. From the home menu, touch .

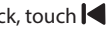
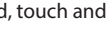
The music from the device plays automatically.

Playback Control

- To play or pause, touch .
- To skip to the previous or next track, touch .
- To search fast backward or forward, touch and hold .
- To select a repeat mode, touch .
- To turn on or off shuffle play, touch .
- To select a preset sound mode, touch .

IMPORTANT NOTE

For best performance, your mobile device volume should be set to maximum.

All volume adjustment should be controlled from the unit.

Bluetooth

Handsfree Call

Make a Call

From the home menu, touch .

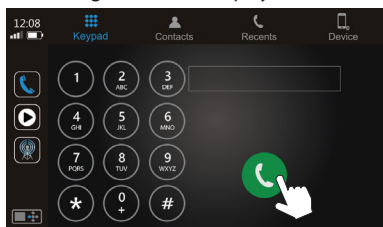

The calling interface is displayed.





3 options to dial a Bluetooth call

- Input a phone number on the virtual keypad, and touch .
- Touch **[Contacts]** tab to access your contact list, then touch a contact.
- Touch **[Recents]** tab to access your call history, then touch a number.

Operation During a Call

- To end a call, touch .
- To mute a call, touch .

- To use a keypad during a call, touch .
- To switch to private mode, touch . The call will move to your mobile device.
- To return to hands-free mode, touch . The call will move back to the unit.

Sync Phonebook and History

Touch **[Contacts]** or **[Recents]** tab, then **[Download]**.

The phonebook and call history from your mobile phone will be displayed on the unit.

Search a Contact

Touch **[Contacts]** tab, then **[Search]**. The alphanumeric keypad is displayed. Enter a contact name for search.

Browse Call History

Touch **[Recents]** tab to display the call history.

Outgoing call



Incoming call



Missed call



Voice Assistant (Push-To-Talk)

View Connection Status

Touch **[Device]** tab to display the paired devices.

- A check mark indicates the currently connected device.
- To connect a paired device, simply touch the paired device name.
- To delete a paired device from the memory, touch .

Voice Assistant (Push-To-Talk)

You can access smartphone voice assistant through the unit.

Before you Start

- Enable Bluetooth connection between your smartphone and the unit, or enable Apple CarPlay/Android Auto.
- Make sure the hands-free microphone is connected to the Microphone Input of the unit for audio input. (P.32)

Touch  on the unit's front panel to activate voice assistant, then speak your command.

USB

USB Playback

You can play audio, video and photos stored on a USB flash drive. Make sure your USB flash drive is connected to the front USB-C port or rear USB-A port.

From the home menu, touch .

Music from the device plays automatically.

If there are audio, video and photo files in the USB, audio files will play first.

Audio/Video/Photo Play Switching

1. In the playback interface, touch . The file browser bar is displayed.



2. Touch [Music], [Video], or [Image] tab to select an audio, video or picture file to play.





IMPORTANT NOTE

Video and photo cannot not be viewed while driving. The vehicle must be stationary and the parking brake applied to enable viewing.

To activate viewing, also make sure the parking brake wire on the unit is properly connected to your vehicle. (P.30)

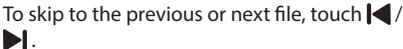
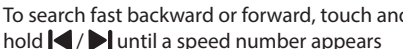

Audio Playback

In the audio playback interface, playback control is displayed.

- To play or pause, touch .
- To skip to the previous or next file, touch .
- To search fast backward or forward, touch and hold  until a speed number appears then touch repeatedly to select a search speed.
- To select a repeat mode, touch .
- To turn on or off shuffle play, touch .
- To search for a file, touch  then enter a number on the virtual numeric keypad.

Video Playback

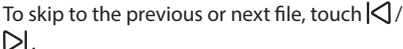
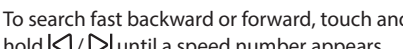
In the video playback interface, touch the screen to display playback control.

- To play or pause, touch .
- To skip to the previous or next file, touch .
- To search fast backward or forward, touch and hold  until a speed number appears then touch repeatedly to select a search speed.
- To select a repeat mode, touch .

Video Settings







During video playback, touch  to access the Brightness / Contrast / Color settings.

Photo Playback

In the photo playback interface, touch the screen to display playback control.

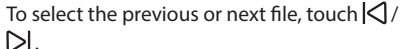
- To play or pause, touch .
- To select the previous or next file, touch .
- To select a repeat mode, touch .
- To enlarge the picture, touch  then drag the magnifying slider.
- To rotate the picture, touch .

WARNING

Watching video or photo while driving is against Federal, State, and Local laws.

Do not use features of this unit if it cannot be operated safely and legally in your location.

Other External Devices

Audio/Video Input

Playback

From the home menu, touch .

Audio or video input screen is displayed.

Audio Input

You can listen to an audio device (e.g. a mobile phone or MP3 player) through this unit.

Audio Cable Connection

Connect the RCA inputs ("L-IN" and "R-IN") on the unit's back to the audio output on your device. (P.31)

If your device does not have an RCA, use the following audio cable (not included).

- For a device with 3.5mm headphone jack, use a 3.5mm to RCA audio cable.
- For a device with USB-C port, use a USB-C to RCA audio cable.
- For an iPhone, use a lightning to RCA audio cable.

Video Input

You can play video from a playback device (e.g. a CD/DVD, ect.).

AV Cable Connection

Using audio/video cables (not included), connect the RCA inputs ("L-IN", "R-IN" and "V-IN") on the unit's back to the RCA outputs (yellow/white/red) on your playback device. (P.31)

IMPORTANT NOTE

Use the controls on the external device for playback control.

Video cannot be viewed while driving. The vehicle must be stationary and the parking brake applied to enable viewing.

WARNING

Never rely solely on the backup camera; always check your surroundings before backing up.



Images may appear reversed if your camera is not properly installed or set up.

Do not use features of this unit if it cannot be operated safely and legally in your location.

Camera

Make sure front/rear camera connection is correctly made. (P.32)

Manual Camera Trigger

From the home menu, touch the rear camera icon () or the front camera icon () to display the camera view.

Note: If the camera icon is grayed out, enable the camera input. From the home menu, touch [SETTINGS] > [Camera].

On the camera view screen, touch the camera icon to switch between front and rear camera view.

Automatic Camera Trigger

When the vehicle is put into reverse gear, the rear camera view will turn on automatically. The front camera view is not accessible when reversing.

IMPORTANT NOTE

For automatic rear camera trigger, make sure the purple/white wire (labeled "REVERSE INPUT") from the supplied wire harness is connected to the reverse light. (P.28)

Sound Settings

Set Sound Effects

From the home menu, touch [SETTINGS] > [Audio] > [EQ] to access sound settings.

Sound Mode and Equalizer Setting



To select a preset sound mode (Jazz, HipHop, Pop, Rock or R&B), touch ◀ or ▶.

To customize equalizer setting, touch ◀ or ▶ until [Custom] appears then swipe up or down each frequency bar to adjust decibel output.

Volume Balance Setting

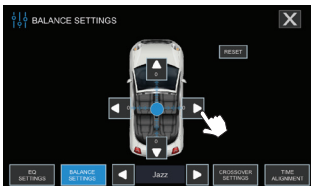

Touch ▲ or ▼ to adjust front and rear volume balance until the sound has a satisfying depth.

Touch ◀ or ▶ to adjust right and left volume balance until you are pleased with the sound and a suitable balance is found.

Crossover Frequency Setting



[HIGH PASS]: Adjust High Pass Filter (HPF) for main audio (radio and media play). Only the frequencies above the one you set will be received to reproduce sound.

[LOW PASS]: Adjust Low Pass Filter (LPF) for main audio (radio and media play). Only the frequencies below the one you set will be received to reproduce sound.

[HPF SLOPE]: Set a high pass filter slope in decibels. An HPF slope determines the rate that attenuates the frequencies below the set one.

[LPF SLOPE]: Set a low pass filter slope in decibels. A LPF slope determines the rate that attenuates the frequencies above the set one.

[SUB Filter]: Adjust the cutoff frequency for the subwoofer. Only the frequencies below the one you set will be received to reproduce sound.

[SUB Level]: Adjust volume output for the subwoofer.

Time Alignment Setting

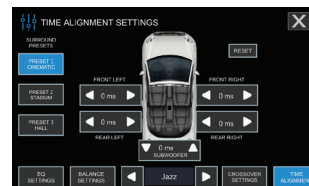

Adjust sound delay time so that sound from all the speakers arrives at the listener simultaneously.

1. Touch a preset button for settings as a listening position. Total three presets can be stored as different listening positions.
2. Touch ◀ or ▶ to set delay time for front and rear speakers, and touch ▲ or ▼ for the subwoofer.

Experiment with different time values to find the optimal settings for you.

To clear the set values, touch [RESET].

System Settings

General Settings

From the home menu, touch [SETTINGS] > [General] to access general settings.

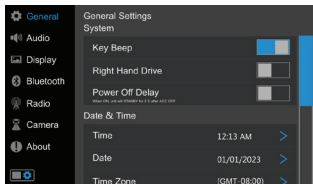

System Tone and Shutdown Delay

[Key Beep]: Enable or disable touch sound.

[Right Hand Drive]: Change the Apple CarPlay menu bar from the left side to the right side of the screen and vice versa. Restart your vehicle to make the change effective.

[Power Off Delay]: Enable to keep the unit on for three seconds after accessory power or vehicle is turned off.

Enable shutdown delay if the unit restarts during vehicle's crank to start.

Set Date and Time Manually

[Time]: Touch to access time setting screen. Swipe the time field up and down to set hours, minutes, and 12/24 hour format respectively.

[Date]: Touch to access date setting screen. Swipe the date field up and down to set year, month, and day respectively.

[Time Zone]: Select a time zone in your current location.

[Daylight Savings Time]: Enable to adjust Daylight Saving automatically.

Set Date and Time Automatically

[Projection Clock Sync]: Enable to automatically set date and time from Apple CarPlay.

[Set Automatically by RDS/RBDS]: Enable to set date and time from RDS/RBDS radio broadcast.

Language Setting

Select English or Spanish as display language for menu.

Steering Wheel Control Retention

The unit allows you to retain your steering wheel controls through connection to a third-party SWC adapter, or to your steering wheel control. (P.28)

[SWC Fixed Settings]: Select this option if your vehicle needs a third-party SWC adapter (not included).

Follow the instructions of your SWC adapter to program the unit's audio and video functions on your steering wheel controls.

[SWC Learning Setup]: Select this option to access function programming if your vehicle does not need a third-party SWC adapter for SWC connection

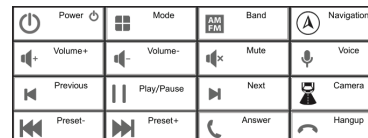

Select a control function from the mapping tool above, then press a steering wheel control in your vehicle. After you complete all function mapping, touch [Confirm].

IMPORTANT NOTE

Not all OEM steering wheel controls may be supported.

System Settings

Audio Settings

From the home menu, touch [SETTINGS] > [Audio] to access audio settings.

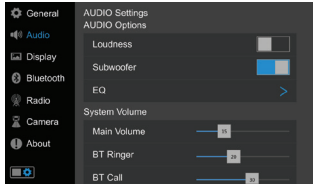

Loudness and Sound Effect Setting

[**Loudness**]: Enable to boost output of low and high frequencies.

[**Subwoofer**]: Enable or disable subwoofer output.

[**EQ**]: Touch to access the following sound effects settings. (P.22)

- Sound Mode and Equalizer
- Volume Balance
- Crossover Frequency
- Time Alignment

Startup Volume Setting

[**Main Volume**]: Set a desired volume for main audio (radio and media play) when the unit starts up with main audio.

1. Adjust the slider to set a new volume value.
2. Startup volume will be the set volume if the set volume is less than the last shutdown volume (as main audio).
Startup volume will be the last shutdown volume if the set volume is greater than the last shutdown volume (as main audio).

Initial Volume Setting for Other Sources

You can set desired initial volumes for the following sources.

- [**BT Ringer**]: Bluetooth ringtone volume.
 - [**BT Call**]: Bluetooth call volume.
 - [**Navigation**]: Navigation volume.
 - [**Voice**]: Voice assistant volume.
1. Adjust the respective volume slider to set a new volume value.

2. Initial volume will be the set volume if the set volume is less than the last used volume.
Initial volume will be the last used volume if the set volume is greater than the last used volume.

Customization of a Source Volume

You can increase or decrease one of the following source volumes, without affecting volume of other sources:

- [**Radio**]: Adjust radio volume alone.
- [**USB**]: Adjust USB playback volume alone.
- [**BT Audio**]: Adjust Bluetooth streaming volume alone.
- [**AV IN**]: Adjust audio input volume alone.
- [**Apple CarPlay**]: Adjust CarPlay volume alone.
- [**Android Auto**]: Adjust Android Auto volume alone.

System Settings

Display Settings

From the home menu, touch [SETTINGS] > [Display] to access display settings.

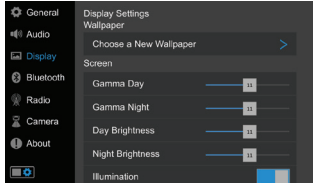

Wallpaper Setting

[Choose a New Wallpaper]: Change a wallpaper for home, radio, or media playback screen.

Screen Setting

[Gamma Day]: Change the differences between dark and light area. Applicable when your vehicle light is turned off.

[Gamma Night]: Change the differences between dark and light area. Applicable when your vehicle light is turned on.

[Day Brightness]: Adjust screen brightness. Applicable when your vehicle light is turned off.

[Night Brightness]: Adjust screen brightness. Applicable when your vehicle light is turned on.

Automatic Dimming Control

[Auto Dimming Control]: When enabled and the vehicle light is turned on, the screen brightness and panel button lights will automatically dim.

IMPORTANT NOTE

To enable night detection and auto dimming, make sure the illumination input wire (Orange) from the supplied wire harness is connected to your vehicle's parking light. (P.28)

Panel Button Light Setting

[Preset Color]: Select one of six colors for panel button lights. Make sure [Animation Effect] option is disabled to make the feature active.

[Animation Effect]: Enable to automatically cycle the panel button lights through six different colors.

Bluetooth Setting

Make sure CarPlay or Android Auto is not connected to enable unit's Bluetooth.

From the home menu, touch [SETTINGS] > [Bluetooth] to access Bluetooth settings.

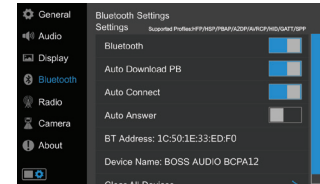

[Bluetooth]: Enable or disable Bluetooth function.

[Auto Download PB]: Enable to download the phonebook from the connected mobile phone.

[Auto Connect]: Enable to automatically connect the paired Bluetooth device.

[Auto Answer]: Enable to automatically answer an incoming call.

[BT Address]: Show the unit's Bluetooth address.

[Device Name]: Show the unit's Bluetooth name.

[Clear All Devices]: Clear all the paired Bluetooth devices from the unit's memory.

System Settings

Radio Settings

From the home menu, touch [SETTINGS] > [Radio] to access radio settings.

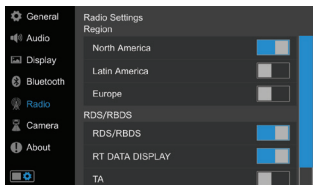

Radio Region Selecting

Select a radio region where your unit is in.

[North America]: Enable if you are in this area.
Tuner spacing: FM (200 kHz), AM (10 kHz)

[Latin America]: Enable if you are in this area.
Tuner spacing: FM (100 kHz), AM (10 kHz)

[Europe]: Enable if you are in this area.
Tuner spacing: FM (50 kHz), AM (9 kHz)

RDS/RBDS Activation

[RDS/RBDS]: Enable or disable RDS/RBDS function.

When disabled, the unit will not receive RDS/RBDS service carried by FM radio signals.

RDS/RBDS Information Display

[RT DATA DISPLAY]: Enable or disable a service that allows FM stations to display additional information (i.e. station name, program type or other dynamic/static message).



Not all FM stations will have or display RDS/RBDS information.

RDS/RBDS Traffic Announcement

[TA]: When enabled, the unit will automatically tune in to traffic information broadcast despite the media source you are currently in.

Once the traffic announcement ends, the original source will automatically resume.

RDS/RBDS Alternative Frequency

[AF]: When enabled, the unit will automatically locate the same tuning program on other stations and select the strongest signal of those being broadcast.

This feature is most useful on long trips when your car goes out of the range of a radio station.

Camera Settings

From the home menu, touch [SETTINGS] > [Camera] to access camera settings.

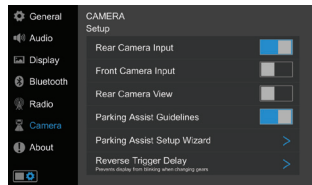

Camera Trigger Control

[Rear Camera Input]: Enable or disable rear camera signal input.

[Front Camera Input]: Enable or disable front camera signal input.

[Rear Camera View]: Enable or disable rear camera view.

[Reverse Trigger Delay]: Delay trigger of rear camera view by a set time. A proper time setting prevents the unit's screen from blinking when shifting gears.



For automatic rear camera trigger, ensure the purple/white wire (labeled "REVERSE INPUT") from the supplied wire harness is connected to the reverse light. (P.28)

System Settings

Camera Settings

Parking Assist Guidelines Setting

[Parking Assist Guidelines]: Disable the parking assist guidelines built in the unit if your rear camera view has its own parking assist guides.

[Parking Assist Setup Wizard]: Adjust the parking assist guidelines built in the unit.

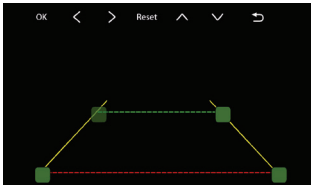

Touch and drag a square icon to reposition the related guideline. Repeatedly touch an arrow icon to fine tune positioning of the related guideline. Touch **[OK]** to confirm the adjustment.

To reset to the default positioning of the guideline, touch **[Reset]**.

System Information

From the home menu, touch **[SETTINGS]** > **[About]** to access system information.

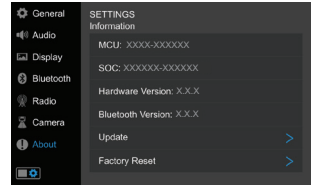

Firmware Version Information

Version information starts with **MCU**, **SOC**, **Hardware Version**, or **Bluetooth Version**.

Firmware Update

We continually try to improve our product. The product can be updated if needed.

[Update]: Touch to prompt firmware update.

Make sure a USB flash drive with a newer firmware is connected to the unit's rear USB port (not the front USB-C port). The firmware file must be saved in the root directory of the USB flash drive. Unzip the file and make sure the file name shows "BIN" extension after zipping.

Resetting the Unit

[Factory Reset]: Reset the unit to the factory settings.



Reset the unit only when the unit fails to function normally. All your settings will be erased after resetting.

Connections

Power and Steering Wheel Control (SWC) Wiring

WARNING

See the section "Installation Warnings". (P.5)

IMPORTANT NOTE

Unused input/output wires need to be insulated with tape, heat shrink, or crimp connectors.

Never use wire nuts.

Always replace the faulty fuse with the same type and rating (15A).

Illumination input wire (Orange) must be connected to the parking light for night detection and auto dimming in screen and panel button lights.

Reverse Input wire (Purple/white) must be connected to the reverse light wire for automatic rear camera trigger when the gear is changed to reverse.

* Power output is max. 500mA, 12V. It is recommended to use a relay if additional power is required.

** Consult a professional installer for a correct third-party SWC adapter for your specific vehicle.

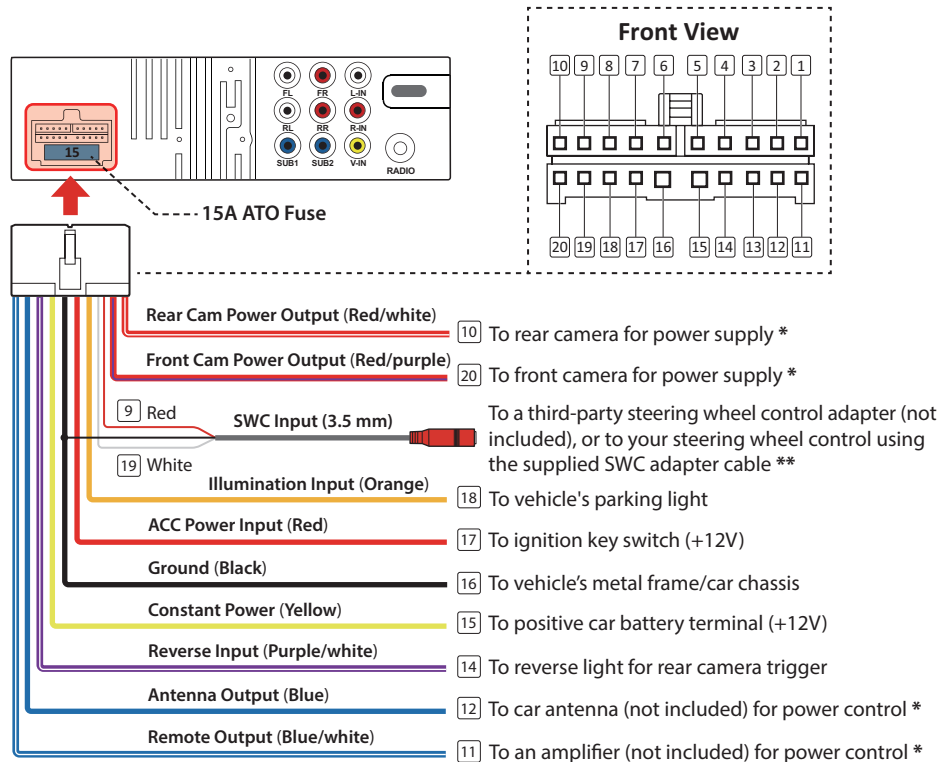

Connections

Speaker Wiring

CAUTION

Do not chassis ground any speaker wire leads.
Only use 4-8 Ω speakers.
DO NOT use 1-3 Ω speakers.
Do not bridge any of the channels. They are only to be wired in stereo mode.

IMPORTANT NOTE

Unused speaker wires need to be insulated with tape, heat shrink, or crimp connectors to avoid damage to the unit. **Never use wire nuts.**
Double check speaker polarity when making connections.

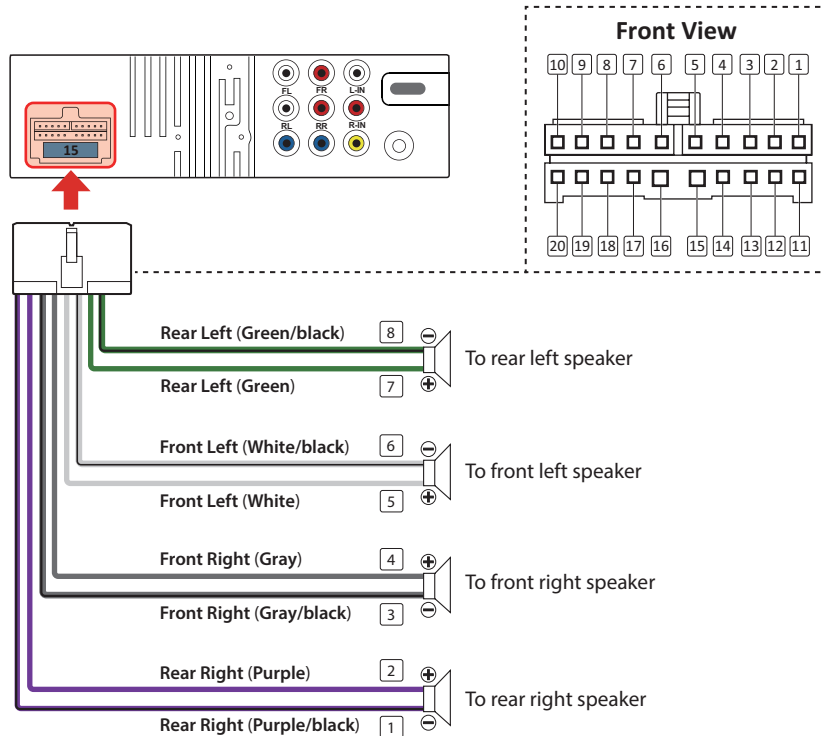

Connections

Parking Brake Wiring

IMPORTANT NOTE

Video and photo playback can be enabled only when the parking brake input wire is connected to your vehicle, and the vehicle's parking brake is engaged.



Park your vehicle in a safe place and engage the parking brake to view video and photo.

WARNING

Improper connection or use of the parking brake status wire (e.g. defeating the safety feature) violates Federal, State, and Local laws. This may lead to injury, property damage, and/or death.

Watching videos or photos while driving is against Federal, State, and Local laws.

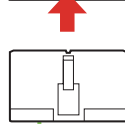
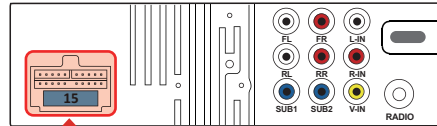

Parking Brake Input (Light green)

13 To vehicle's parking brake switch

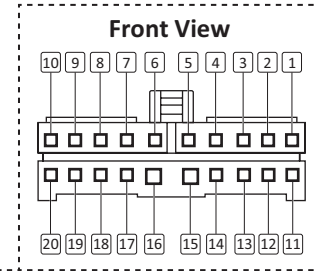

Note

Parking brake wire location varies from vehicles. Consult a professional installer.

Connections

AV/Radio

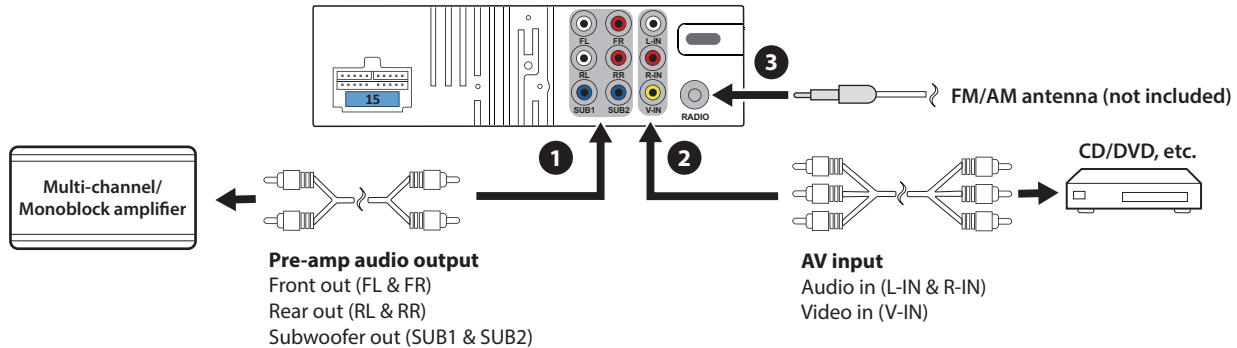

IMPORTANT NOTE

Subwoofer pre-amp is a non-fading mono output.

Always run signal wires away from power cables to reduce the possibility of noise.

- 1 Using RCA audio cables (not included), connect the audio output on the unit to an external amplifier (not included).
- 2 Using RCA audio cables (not included), connect the audio input ("L-IN" and "R-IN") on the unit to a CD player.
Or using an RCA to 3.5mm/USB-C/lightning adapter (not included), connect the audio input ("L-IN" and "R-IN") to the audio output on your mobile phone.
Using a yellow RCA cable (not included), connect the video input ("V-IN") on the unit to the video output on a DVD or other video playback player.
- 3 Connect an FM/AM antenna (not included) for better radio reception.

Connections

Mic/Camera/CarPlay/Android Auto

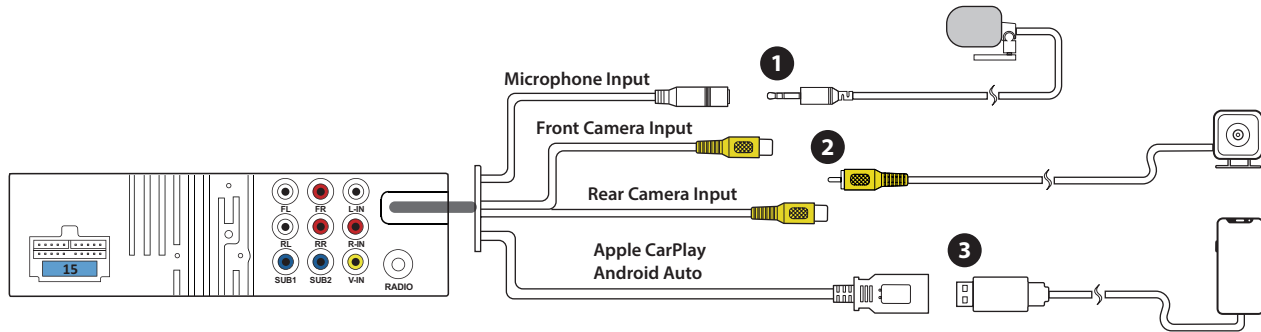

1 Connect the 3.5mm plug of the supplied hands-free microphone for sound input when using phone call or voice assistance through Bluetooth or CarPlay/Android Auto.

2 Connect the RCA plug of your camera for video signal input.
To operate your rear camera, you also need to connect camera power and reverse signal. (P.28)

Refer to the installation instructions of your camera for installation.

3 Connect the lightning cable or USB cable of your iPhone or Android device to enable use of CarPlay or Android Auto.
You may also connect a USB flash drive for media playback.



Never rely solely on the backup camera. Always check your surroundings before backing up.

Images may appear reversed if your camera is not properly installed or set up.

Do not use features of this unit if it cannot be operated safely and legally in your location.

Connections

Hands-Free Mic Installation

Placement

The unit comes with a hands-free microphone with sticky base and 10ft wire.

The location of the microphone can vary from different vehicles due to layout, interior materials, etc.

The **Red** shaded areas are the recommended locations for best microphone performance.

Items to look for before placement:

- Do not place in front of air vents.
- If the vehicle has tweeters placed on sail panel, do **NOT** locate the microphone on steering column area.
- The front of the microphone must not be blocked.
- Microphone should be firmly attached to mounting location.
- Do not cover the grille openings surrounding the microphone.
- To avoid excessive wind noise, do not place near the sunroof opening.

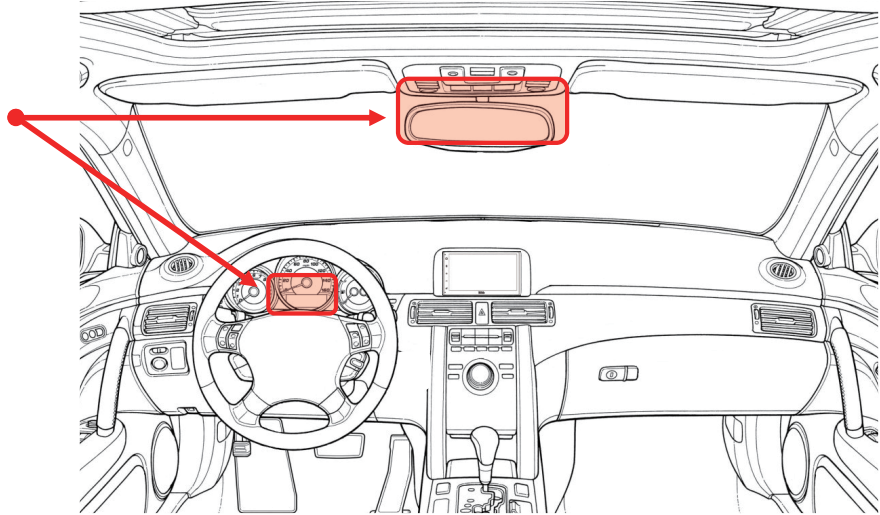

Attach the Microphone

1. Clean the mounting surface.
2. Remove the backing paper from the microphone base, then stick the base onto the mounting surface.
3. Route and secure the microphone wire properly.



WARNING
Run the microphone wire where it will **NOT** impede with the operation of any safety items (e.g. airbags, knee airbags, etc.)

Troubleshooting

Important!

If you have checked the points described in the list and the problem persists, turn off the vehicle for ten seconds then turn it back on again.

If the problem still persists after restarting the unit, reset the unit by using a small pin to press the reset button on the bottom side of the display.

If you still have problems after applying suggestions above, please contact our Customer Service for further assistance.

General

No response from the unit.

- Restart the unit by turning off the vehicle for ten seconds, then turning the vehicle back on.

No sound from the unit.

- The unit is muted. Adjust the volume.
- Select the correct audio source on the unit.

USB

Cannot play a media file.

- The file format on the USB flash drive is not supported by the unit. Change media files.
- The file system of the USB flash drive is not supported by the unit. Change the USB drive.

No video playback or picture display.

- Video or picture display is enabled only when the parking brake is engaged, and the parking brake input wire is connected to your vehicle. (P.30)

Apple CarPlay/Android Auto

Cannot start Apple CarPlay/Android Auto

- Bad USB cable. Replace the cable.
- The mobile phone is locked. Unlock it.
- CarPlay/Android Auto is frozen. Unplug the mobile phone, close all apps and plug the phone in again.

Bluetooth

Cannot make Bluetooth streaming.

- Make sure your mobile phone is within Bluetooth range.
- Pair and connect your mobile phone. (P.18)
- CarPlay or Android Auto is being connected. Unplug your mobile phone from the unit to enable Bluetooth connection.

Poor hands-free phone call quality.

- Check signal strength on your mobile phone.

- Check that the microphone is firmly attached and plugged in. Or relocate the microphone for noise reduction. (P.33)

Cannot make Bluetooth connection.

- CarPlay/Android Auto connection disables Bluetooth on the unit. Unplug CarPlay or Android Auto from the unit to enable Bluetooth connection.
- The unit is already connected to a mobile device. Disconnect the current Bluetooth connection before connecting to another Bluetooth device.

FM/AM Radio

Poor radio reception.

- FM/AM antenna is not connected or extended. Connect and secure an FM/AM antenna (not included). (P.31)
- The antenna output wire is not connected. Connect the wire. (P.28)
- Turn off RDS/RBDS, TA and AF. (P.26)

Specifications

General

Input voltage.....	8.5 – 18 VDC 14.4 VDC (Nominal)
Current consumption	Max. 15 A
Fuse	15 A (ATO, blade)
Dimensions (H x W x D).....	1.97" x 7" x 4.9"
Unit weight.....	4.33lbs.
Operational temperature	-4 – 140°F

Display

Screen size	12"
Aspect ration.....	16:9
Resolution	1366 x 768
Screen type.....	TFT-LED Active Matrix

Audio

Max power	85 W x 4
Speaker impedance.....	4 – 8 Ω
Preset EQ.....	Jazz, HipHop, Pop, Rock, R&B
EQ bands (Adjustable).....	32/63/125/250/500 Hz 1/2/4/8/16 kHz
EQ boost/cut	\pm 6 dB

Pre-amp output.....	2x Front (4V, full range) 2x Rear (4V, full range) 2x Sub (mono, 4V, LPF)
Sub LPF.....	50/80/120/160 Hz
Sub Level	+1 to +14 dB

Radio

Frequency range.....	87.5 – 108 MHz (FM) 522 – 1710 kHz (AM)
Frequency step (FM).....	200 kHz (USA) 100 kHz (Latam) 50 kHz (Europe)
RDS/RBDS.....	RT data , TA, AF

Apple CarPlay

Device support	iPhone 5 or later
iOS.....	iOS 7.1 or later

Android Auto

Android	6.0 or later
---------------	--------------

USB

Rear USB port.....	USB-A (2.0, High Speed) CarPlay/Android Auto Charging (1.5A)
Front USB port	USB-C Charging (1.5A)
Supported USB	Max. 32GB
File system.....	FAT32
Audio playback.....	MP3, WMA, WAV, FLAC (192kHz/24bit)
Video playback.....	AVI, MKV, WMV
Picture playback.....	JPG, PNG, BMP

Note: Not all listed media files are guaranteed to play due to different creation methods or file contents.

Bluetooth

Bluetooth version.....	V5.2 + EDR
Transmission range.....	33ft/10m (line of sight)
Bluetooth profiles.....	A2DP, AVRCP, HFP, PBAP, HSP, HID, GATT, SPP

Specifications are subject to change without notice.



BOSS Audio Systems
3451 Lunar Court - Oxnard, CA 93030
www.bossaudio.com
805-751-4853 Customer Service
Tech Support: www.bossaudio.com/support



0623

iPhone® is a trademark of Apple Inc., registered in the U.S. and other countries. Apple CarPlay is a trademark of Apple Inc. BOSS Audio Systems is not affiliated with Apple Inc.

The Bluetooth® word mark and logos are registered trademarks owned by Bluetooth SIG, Inc. and any use of such marks by BOSS Audio Systems is under license. Other trademarks and trade names are those of their respective owners.

Android Auto is a trademark of Google LLC.

Use of the Apple CarPlay logo means that this user interface meets Apple performance standards. Apple is not responsible for the operation of this device or its compliance with safety and regulatory standards.