







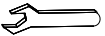

ASSEMBLY INSTRUCTION

ITEM: 6950-90267-80 6/0-6/6 Cane Panel Headboard
 6950-90268-80 6/0-6/6 Cane Panel Footboard
 6950-90253-80 6/6 Cane Panel Rails
 6950-90263-80 6/0 Cane Panel Rails

Thank you for purchasing this quality product. Be sure to unpack carefully looking for small parts which may have come loose during shipment.
 Read all instruction and study the drawing carefully before starting the assembly process.

| HARDWARE PACK | | | | |
|---------------|---|---------------|----------|--------|
| NO. | DRAWING | DESCRIPTION | SIZE | Q'TY |
| A |  | Threaded Rod | Ø3/8"*4" | 8 PCS |
| B |  | Curved Washer | Ø3/8" | 8 PCS |
| C |  | Nut | Ø3/8" | 8 PCS |
| D |  | Open Wrench | Ø3/8" | 1 PC |
| E |  | Screw | 1 1/4" | 20 PCS |

| PARTS LIST | | | |
|------------|---|-------------|-------|
| NO. | DRAWING | DESCRIPTION | Q'TY |
| 1 |  | Headboard | 1 PC |
| 2 |  | Rail | 2 PCS |
| 3 |  | Footboard | 1 PC |
| 4 |  | Slat | 5 PCS |
| 5 |  | Support Leg | 5 PCS |

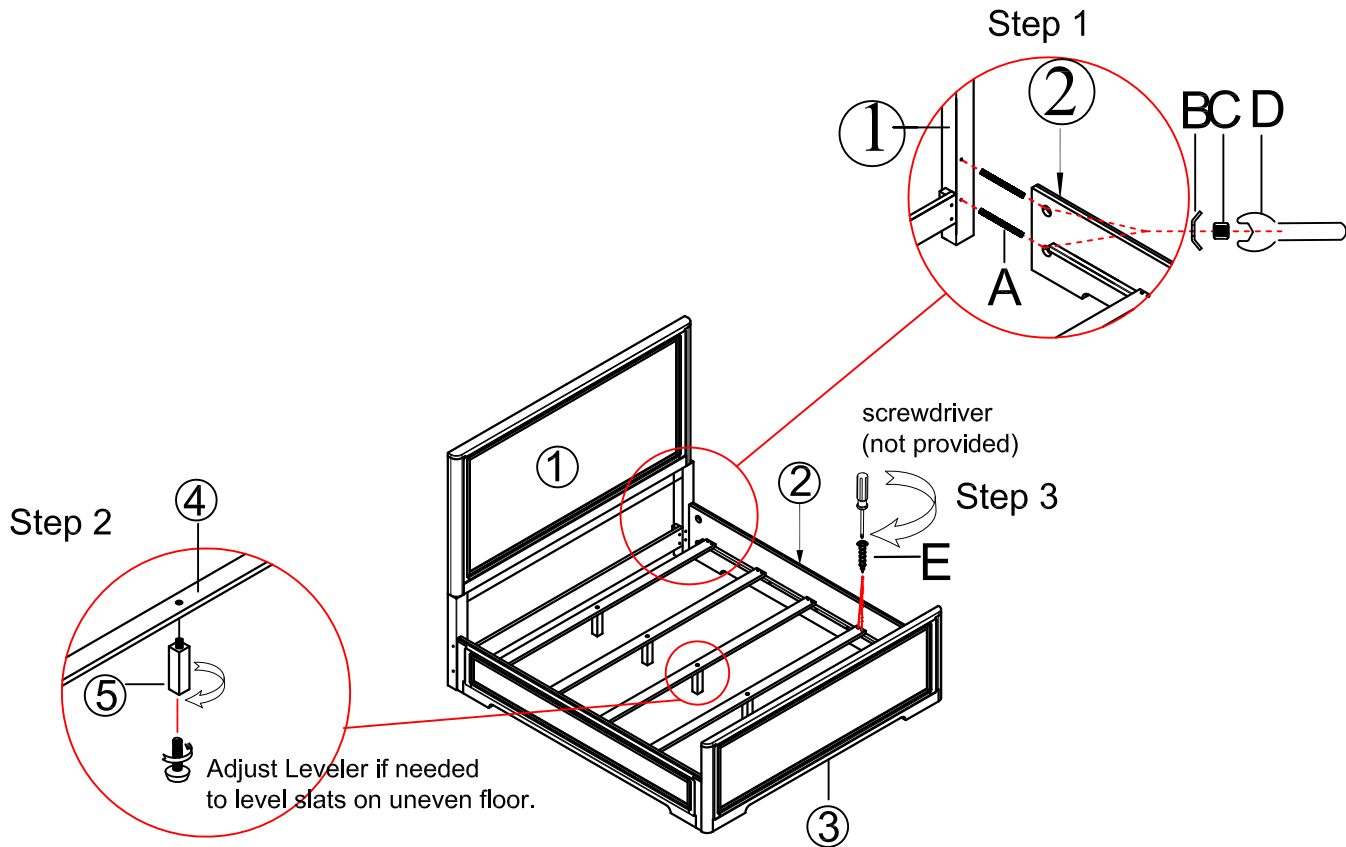

Step 1: Attach Rails (2) to Headboard (1) and Footboard (3) by using Threaded Rods (A), Curved Washers (B) and Nuts (C), tighten them with Open Wrench (D) .

Step 2: Attach support legs (5) to slats (4).

Step 3: Attach slats (4) to the rails (2) and tighten them by using Phillips head screwdriver.