

SIDES	BOTTOM
1pcs #1/4-28×3/8 Screws Installed	
Material:Steel-Welding tube, zinc plated	

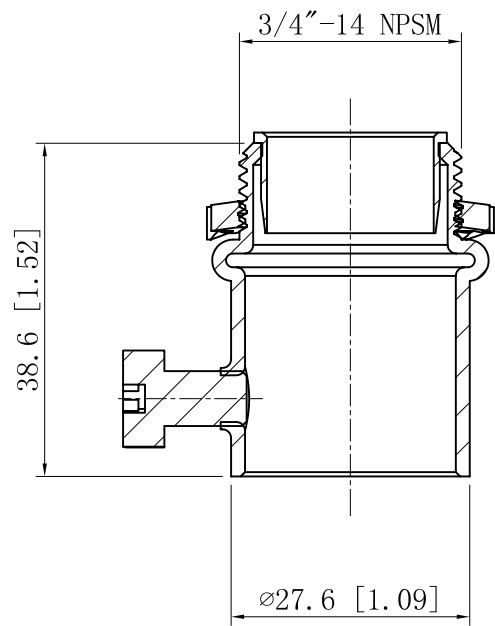

CUTAWAY VIEW A-A

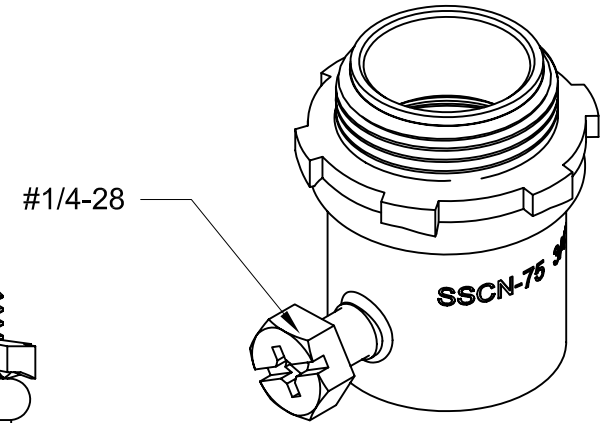
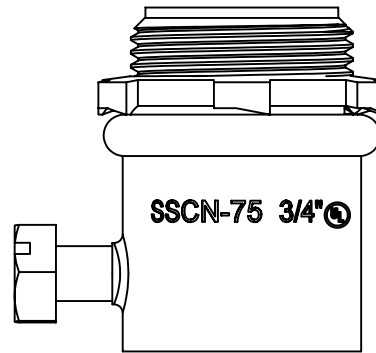
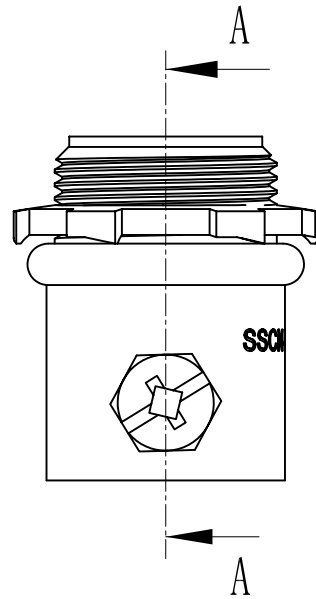

DESCRIPTION
TRADE REFERENCE TERMS

STANDARD PACKING
50 PCS

This data sheet is for reference only .GARVIN INDUSTRIES reserves the right to make changes to the design without prior notice.

<b>GARVIN INDUSTRIES</b>			
TITLE STEEL EMT SET SCREW CONNECTORS			
SIZE A4	DWG NO.	SSCN-75I	REV A
DATA SHEET			