

FUTUREGLASS GLASS WAREHOUSE

FABRIKASI POSTED GLASS RAILING SYSTEM

GENERAL NOTES:

1. THE PRODUCT SHOWN HEREIN IS DESIGNED AND MANUFACTURED TO COMPLY WITH THE CURRENT EDITION OF THE INTERNATIONAL BUILDING CODE (IBC).
2. FOR FALL PROTECTION REQUIREMENTS, THIS PRODUCT HAS BEEN ANALYZED IN ACCORDANCE WITH SECTION 1607.9.1 AND MEETS THE REQUIREMENTS OF THE 50 PLF LINEAR LOAD AND 200 LB CONCENTRATED LOAD SPECIFIED IN ASCE 7 SECTION 4.5.1.
3. ADEQUACY OF THE EXISTING STRUCTURAL CONCRETE/MASONRY AND 2X FRAMING AS A MAIN WIND FORCE RESISTING SYSTEM CAPABLE OF WITHSTANDING AND TRANSFERRING APPLIED PRODUCT LOADS TO THE FOUNDATION IS THE RESPONSIBILITY OF THE ENGINEER OR ARCHITECT OF RECORD FOR THE PROJECT OF INSTALLATION.
4. THE INSTALLATION DETAILS DESCRIBED HEREIN ARE GENERIC AND MAY NOT REFLECT ACTUAL CONDITIONS FOR A SPECIFIC SITE. IF SITE CONDITIONS CAUSE INSTALLATION TO DEVIATE FROM THE REQUIREMENTS DETAILED HEREIN, A LICENSED ENGINEER OR ARCHITECT SHALL PREPARE SITE SPECIFIC DOCUMENTS FOR USE WITH THIS DOCUMENT.
5. APPROVED IMPACT PROTECTIVE SYSTEM **IS REQUIRED** ON THIS PRODUCT IN AREAS REQUIRING IMPACT RESISTANCE.
6. POST MATERIAL: 6063-T5 ALUMINUM
7. GLASS MEETS THE REQUIREMENTS OF ASTM E1300 GLASS CHARTS. SEE SHEET 4 FOR QUALIFIED GLASS OPTIONS.

INSTRUCTIONS FOR USE:

1. DETERMINE DESIGN WIND LOAD REQUIREMENTS BASED ON WIND VELOCITY, BUILDING HEIGHT, AND WIND ZONE USING THE APPLICABLE ASCE 7 STANDARD. (SEE SHEET 7 FOR TYPICAL WIND LOADS).
2. SEE DESIGN PRESSURE TABLES ON SHEET 3 FOR DESIRED POST SPACING AND POST HEIGHT.
3. SELECT GLASS TYPE FROM SHEET 4 WITH DESIGN PRESSURE HIGHER THAN STEP 1 ABOVE.
4. SELECT ANCHOR TYPE FROM SHEETS 5 & 6 WITH DESIGN PRESSURE HIGHER THAN STEP 1 ABOVE.

TABLE OF CONTENTS	
SHEET	SHEET DESCRIPTION
1	GENERAL NOTES
2	ELEVATION
3	POST DESIGN PRESSURE TABLES
4	GLASS ALLOWABLE WIND LOAD TABLES
5	ANCHOR SCHEDULE AND INSTALLATION DETAIL
6	ALLOWABLE ANCHOR WIND LOAD TABLES
7	ALLOWABLE WIND LOADS PER ASCE 7
8	WIND SPEED MAP

FUTUREGLASS

GLASSWAREHOUSE

FUTUREGLASS
GLASS WAREHOUSE
1319 ROCKY POINT DRIVE, SUITE 200
OCEANSIDE, CA 92056

TITLE: FABRIKASI POSTED GLASS RAILING SYSTEM

GENERAL NOTES

PREPARED BY: BUILDING DROPS, INC.

1900 NE MIAMI COURT, STE. 2-15
MIAMI, FL 33132
PH: (954)399-8478
FAX: (954)744-4738
WEB: www.buildingdrops.com



REMARKS	BY	DATE
DRAWING FORMAT UPDATE	DI	11/2024

THE INSTALLATION DETAILS DESCRIBED HEREIN ARE GENERIC AND MAY NOT REFLECT ACTUAL CONDITIONS FOR A SPECIFIC SITE. IF SITE CONDITIONS CAUSE INSTALLATION TO DEVIATE FROM THE REQUIREMENTS DETAILED HEREIN, A LICENSED ENGINEER OR ARCHITECT SHALL PREPARE SITE SPECIFIC DOCUMENTS FOR USE WITH THIS DOCUMENT.

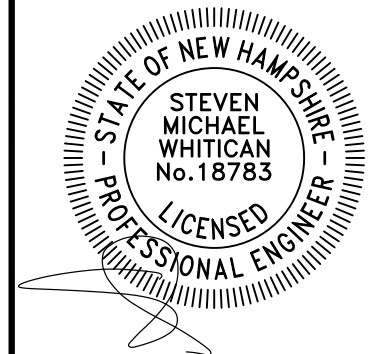

BUILDING DROPS, INC
1900 NE MIAMI COURT, STE. 2-15
MIAMI, FL 33132
FBPE CERT. OF AUTHORIZATION No. 29578

DATE: **07.30.2024**

DWG. BY: SH	CHK. BY: HFN
-----------------------	------------------------

SCALE: **NTS**

DWG. #: **GLW001**

SHEET:
1
OF 8

c:\users\y\manivata\building_drops\inc\building_drops\landing - common\projects\glass_warehouse_1c\rev-24-0946.1 - engineering_evaluation - base shoe system and posted glass railing\dwgs\post_rail\other states\glw001.dwg 1/30/2025 12:18 PM

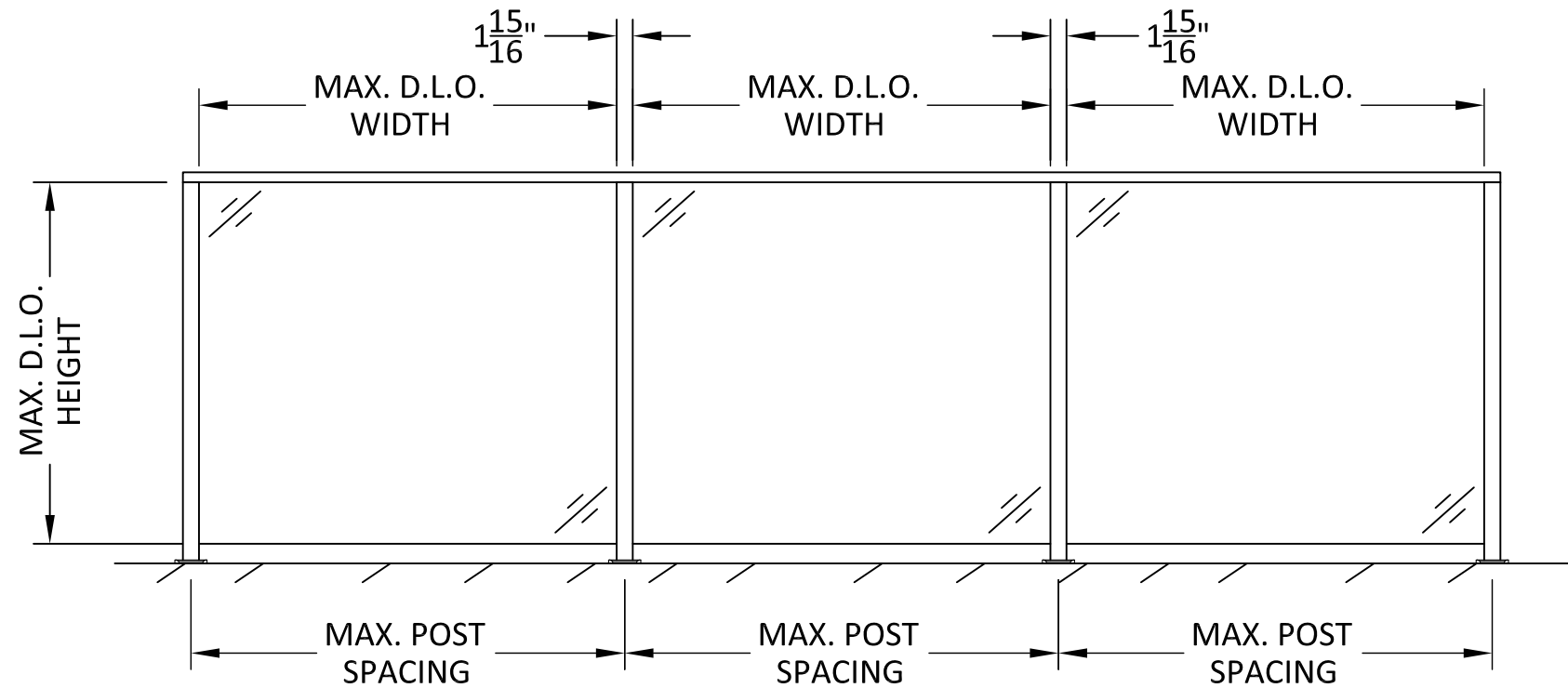

TYPICAL POSTED RAILING ELEVATION

GLASS WIDTH = POST SPACING - .663"
GLASS HEIGHT = VARIES

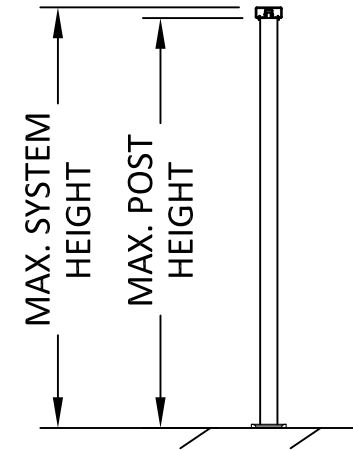

TYPICAL VERTICAL SECTION

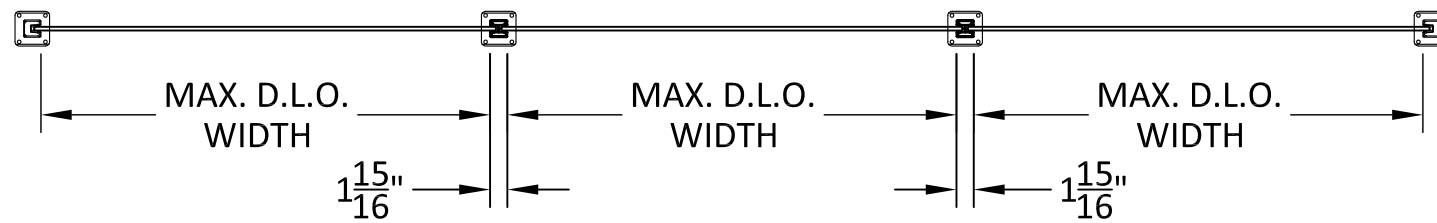

TYPICAL TOP VIEW

FUTUREGLASS

GLASSWAREHOUSE

FUTUREGLASS
GLASS WAREHOUSE
1319 ROCKY POINT DRIVE, SUITE 200
OCEANSIDE, CA 92056

TITLE: FABRIKASI POSTED GLASS RAILING SYSTEM

ELEVATION

PREPARED BY: BUILDING DROPS, INC.

1900 NE MIAMI COURT, STE. 2-15
MIAMI, FL 33132
PH: (954)399-8478
FAX: (954)744-4738
WEB: www.buildingdrops.com



REMARKS	BY	DATE
DRAWING FORMAT UPDATE	DI	11/2024

THE INSTALLATION DETAILS DESCRIBED HEREIN ARE GENERIC AND MAY NOT REFLECT ACTUAL CONDITIONS FOR A SPECIFIC SITE. IF SITE CONDITIONS CAUSE INSTALLATION TO DEVIATE FROM THE REQUIREMENTS DETAILED HEREIN, A LICENSED ENGINEER OR ARCHITECT SHALL PREPARE SITE SPECIFIC DOCUMENTS FOR USE WITH THIS DOCUMENT.

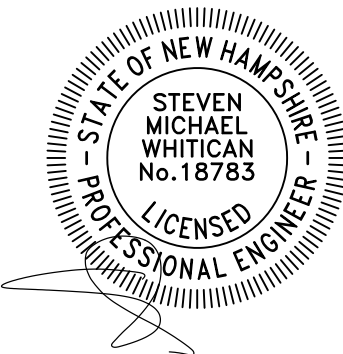

BUILDING DROPS, INC
1900 NE MIAMI COURT, STE. 2-15
MIAMI, FL 33132
FBPE CERT. OF AUTHORIZATION No. 29578

DATE: 07.30.2024

DWG. BY: SH CHK. BY: HFN

SCALE: NTS

DWG. #: GLW001

SHEET: 2 OF 8

INTERMEDIATE POST

ALLOWABLE INTERMEDIATE POST WIND LOAD (PSF)								
POST HEIGHT (IN.)	POST SPACING (IN.)							
	36	42	48	54	60	66	72	78
36	87.7	75.1	65.7	58.4	52.6	47.8	43.8	40.5
42	64.4	55.2	48.3	42.9	38.6	35.1	32.2	29.7
48	49.3	42.3	37.0	32.9	29.6	26.9	24.7	22.8
54	39.0	33.4	29.2	26.0	23.4	21.3	-	-
60	31.6	27.1	23.7	21.0	18.9	-	-	-

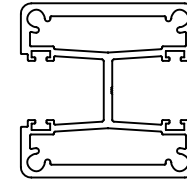

END POST

ALLOWABLE INTERMEDIATE POST WIND LOAD (PSF)								
POST HEIGHT (IN.)	POST SPACING (IN.)							
	36	42	48	54	60	66	72	78
36	166.9	143.0	125.2	111.2	100.1	91.0	83.4	77.0
42	122.6	105.1	91.9	81.7	73.6	66.9	61.3	56.6
48	93.9	80.5	70.4	62.6	56.3	51.2	46.9	43.3
54	74.2	63.6	55.6	49.4	44.5	40.5	37.1	34.2
60	60.1	51.5	45.1	40.0	36.0	32.8	30.0	27.7

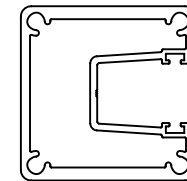

90 DEGREE CORNER POST

ALLOWABLE INTERMEDIATE POST WIND LOAD (PSF)								
POST HEIGHT (IN.)	POST SPACING (IN.)							
	36	42	48	54	60	66	72	78
36	133.5	114.4	100.1	89.0	80.1	72.8	66.7	61.6
42	98.1	84.1	73.6	65.4	58.8	53.5	49.0	45.3
48	75.1	64.4	56.3	50.1	45.1	41.0	37.5	34.7
54	59.3	50.9	44.5	39.6	35.6	32.4	29.7	27.4
60	-	-	-	-	-	-	-	-

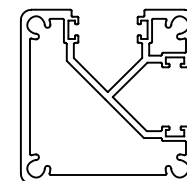

FUTUREGLASS

GLASSWAREHOUSE

FUTUREGLASS
GLASS WAREHOUSE
1319 ROCKY POINT DRIVE, SUITE 200
OCEANSIDE, CA 92056

TITLE: FABRIKASI POSTED GLASS
RAILING SYSTEM

POST DESIGN
PRESSURE TABLES

PREPARED BY:
BUILDING DROPS, INC.

1900 NE MIAMI COURT, STE. 2-15
MIAMI, FL 33132
PH: (954)399-8478
FAX: (954)744-4738
WEB: www.buildingdrops.com



REMARKS	BY	DATE
DRAWING FORMAT UPDATE	DI	11/2024

THE INSTALLATION DETAILS DESCRIBED HEREIN ARE GENERIC AND MAY NOT REFLECT ACTUAL CONDITIONS FOR A SPECIFIC SITE. IF SITE CONDITIONS CAUSE INSTALLATION TO DEVIATE FROM THE REQUIREMENTS DETAILED HEREIN, A LICENSED ENGINEER OR ARCHITECT SHALL PREPARE SITE SPECIFIC DOCUMENTS FOR USE WITH THIS DOCUMENT.

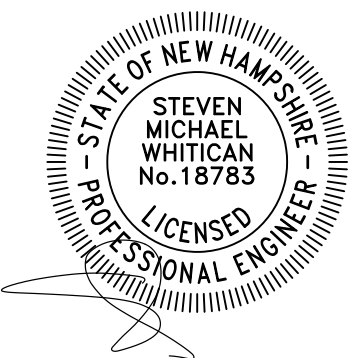

BUILDING DROPS, INC
1900 NE MIAMI COURT, STE. 2-15
MIAMI, FL 33132
FBPE CERT. OF AUTHORIZATION No. 29578

DATE: 07.30.2024

DWG. BY: SH
CHK. BY: HFN

SCALE: NTS

DWG. #: GLW001

SHEET:

3

OF 8

GLASS ALLOWABLE WIND LOAD TABLES

TABLE 2: 5/16" MONOLITHIC TEMPERED GLASS

ALLOWABLE GLASS WIND LOAD TABLE (PSF)								
GLASS HEIGHT (IN)	POST SPACING (IN)							
	36.0	42.0	48.0	54.0	60.0	66.0	72.0	78.0
36.0	121.3	89.1	68.2	-	-	-	-	-
42.0	121.3	89.1	68.2	53.9	-	-	-	-
48.0	121.3	89.1	68.2	53.9	43.7	-	-	-
54.0	121.3	89.1	68.2	53.9	43.7	36.1	-	-
60.0	121.3	89.1	68.2	53.9	43.7	36.1	30.3	-

TABLE 3: 3/8" MONOLITHIC TEMPERED GLASS

ALLOWABLE GLASS WIND LOAD TABLE (PSF)								
GLASS HEIGHT (IN)	POST SPACING (IN)							
	36.0	42.0	48.0	54.0	60.0	66.0	72.0	78.0
36.0	179.2	131.7	100.8	79.7	64.5	53.3	44.8	-
42.0	179.2	131.7	100.8	79.7	64.5	53.3	44.8	38.2
48.0	179.2	131.7	100.8	79.7	64.5	53.3	44.8	38.2
54.0	179.2	131.7	100.8	79.7	64.5	53.3	44.8	38.2
60.0	179.2	131.7	100.8	79.7	64.5	53.3	44.8	38.2

TABLE 4: 1/2" MONOLITHIC TEMPERED GLASS

ALLOWABLE GLASS WIND LOAD TABLE (PSF)								
GLASS HEIGHT (IN)	POST SPACING (IN)							
	36.0	42.0	48.0	54.0	60.0	66.0	72.0	78.0
36.0	312.9	229.9	176.0	139.1	112.6	93.1	78.2	66.7
42.0	312.9	229.9	176.0	139.1	112.6	93.1	78.2	66.7
48.0	312.9	229.9	176.0	139.1	112.6	93.1	78.2	66.7
54.0	312.9	229.9	176.0	139.1	112.6	93.1	78.2	66.7
60.0	312.9	229.9	176.0	139.1	112.6	93.1	78.2	66.7

TABLE 4: 7/16" O.A. LAMINATED GLASS: 3/16" TEMPERED GLASS - 0.060" PVB - 3/16" TEMPERED GLASS

ALLOWABLE GLASS WIND LOAD TABLE (PSF)								
GLASS HEIGHT (IN)	POST SPACING (IN)							
	36.0	42.0	48.0	54.0	60.0	66.0	72.0	78.0
36.0	136.8	108.2	88.4	73.9	-	-	-	-
42.0	136.8	108.2	88.4	73.9	62.9	54.2	-	-
48.0	136.8	108.2	88.4	73.9	62.9	54.2	47.2	41.5
54.0	136.8	108.2	88.4	73.9	62.9	54.2	47.2	41.5
60.0	136.8	108.2	88.4	73.9	62.9	54.2	47.2	41.5

TABLE 5: 7/16" O.A. LAMINATED GLASS: 3/16" TEMPERED GLASS - 0.060" SENTRYGLAS - 3/16" TEMPERED GLASS

ALLOWABLE GLASS WIND LOAD TABLE (PSF)								
GLASS HEIGHT (IN)	POST SPACING (IN)							
	36.0	42.0	48.0	54.0	60.0	66.0	72.0	78.0
36.0	234.7	175.2	135.6	108.0	87.9	73.0	61.5	52.5
42.0	234.7	175.2	135.6	108.0	87.9	73.0	61.5	52.5
48.0	234.7	175.2	135.6	108.0	87.9	73.0	61.5	52.5
54.0	234.7	175.2	135.6	108.0	87.9	73.0	61.5	52.5
60.0	234.7	175.2	135.6	108.0	87.9	73.0	61.5	52.5

TABLE 6: 9/16" O.A. LAMINATED GLASS: 1/4" TEMPERED GLASS - 0.060" PVB - 1/4" TEMPERED GLASS

ALLOWABLE GLASS WIND LOAD TABLE (PSF)								
GLASS HEIGHT (IN)	POST SPACING (IN)							
	36.0	42.0	48.0	54.0	60.0	66.0	72.0	78.0
36.0	188.1	147.8	120.3	100.4	85.3	73.6	64.2	-
42.0	188.1	147.8	120.3	100.4	85.3	73.6	64.2	56.5
48.0	188.1	147.8	120.3	100.4	85.3	73.6	64.2	56.5
54.0	188.1	147.8	120.3	100.4	85.3	73.6	64.2	56.5
60.0	188.1	147.8	120.3	100.4	85.3	73.6	64.2	56.5

TABLE 7: 9/16" O.A. LAMINATED GLASS: 1/4" TEMPERED GLASS - 0.060" SENTRYGLAS - 1/4" TEMPERED GLASS

ALLOWABLE GLASS WIND LOAD TABLE (PSF)								
GLASS HEIGHT (IN)	POST SPACING (IN)							
	36.0	42.0	48.0	54.0	60.0	66.0	72.0	78.0
36.0	326.4	244.4	189.5	151.1	123.2	102.3	86.3	73.7
42.0	326.4	244.4	189.5	151.1	123.2	102.3	86.3	73.7
48.0	326.4	244.4	189.5	151.1	123.2	102.3	86.3	73.7
54.0	326.4	244.4	189.5	151.1	123.2	102.3	86.3	73.7
60.0	326.4	244.4	189.5	151.1	123.2	102.3	86.3	73.7

FUTUREGLASS

GLASSWAREHOUSE

FUTUREGLASS
GLASS WAREHOUSE
1319 ROCKY POINT DRIVE, SUITE 200
OCEANSIDE, CA 92056

TITLE: FABRIKASI POSTED GLASS RAILING SYSTEM

GLASS ALLOWABLE WIND LOAD TABLES

PREPARED BY: BUILDING DROPS, INC.

1900 NE MIAMI COURT, STE. 2-15
MIAMI, FL 33132
PH: (954)399-8478
FAX: (954)744-4738
WEB: www.buildingdrops.com



REMARKS	BY	DATE
DRAWING FORMAT UPDATE	DI	11/2024

THE INSTALLATION DETAILS DESCRIBED HEREIN ARE GENERIC AND MAY NOT REFLECT ACTUAL CONDITIONS FOR A SPECIFIC SITE. IF SITE CONDITIONS CAUSE INSTALLATION TO DEVIATE FROM THE REQUIREMENTS DETAILED HEREIN, A LICENSED ENGINEER OR ARCHITECT SHALL PREPARE SITE SPECIFIC DOCUMENTS FOR USE WITH THIS DOCUMENT.

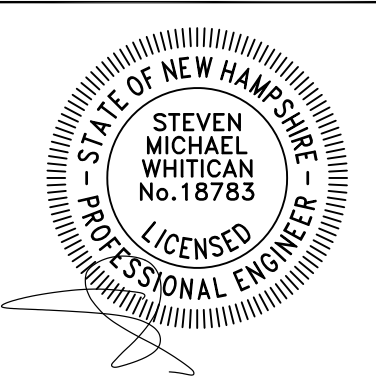

BUILDING DROPS, INC
1900 NE MIAMI COURT, STE. 2-15
MIAMI, FL 33132
FBPE CERT. OF AUTHORIZATION No. 29578

DATE: 07.30.2024

DWG. BY: SH CHK. BY: HFN

SCALE: NTS

DWG. #: GLW001

SHEET:

4

OF 8

c:\users\y\Documents\building_drops\nc\building_drops\glass_warehouse_lic\rev-24-09\46.1 - engineering evaluation - base shoe system and posted glass railing\dwgs\post_railing\other states\glw001.dwg 1/30/2025 12:18 PM

c:\users\y\antwata\building_drops\nc\building_drops\warehouse_1c\rev-24-0946.1 - engineering evaluation - base shoe system and posted glass railing\dwg\post_rail\other states\glw001.dwg 1/30/2025 12:18 PM

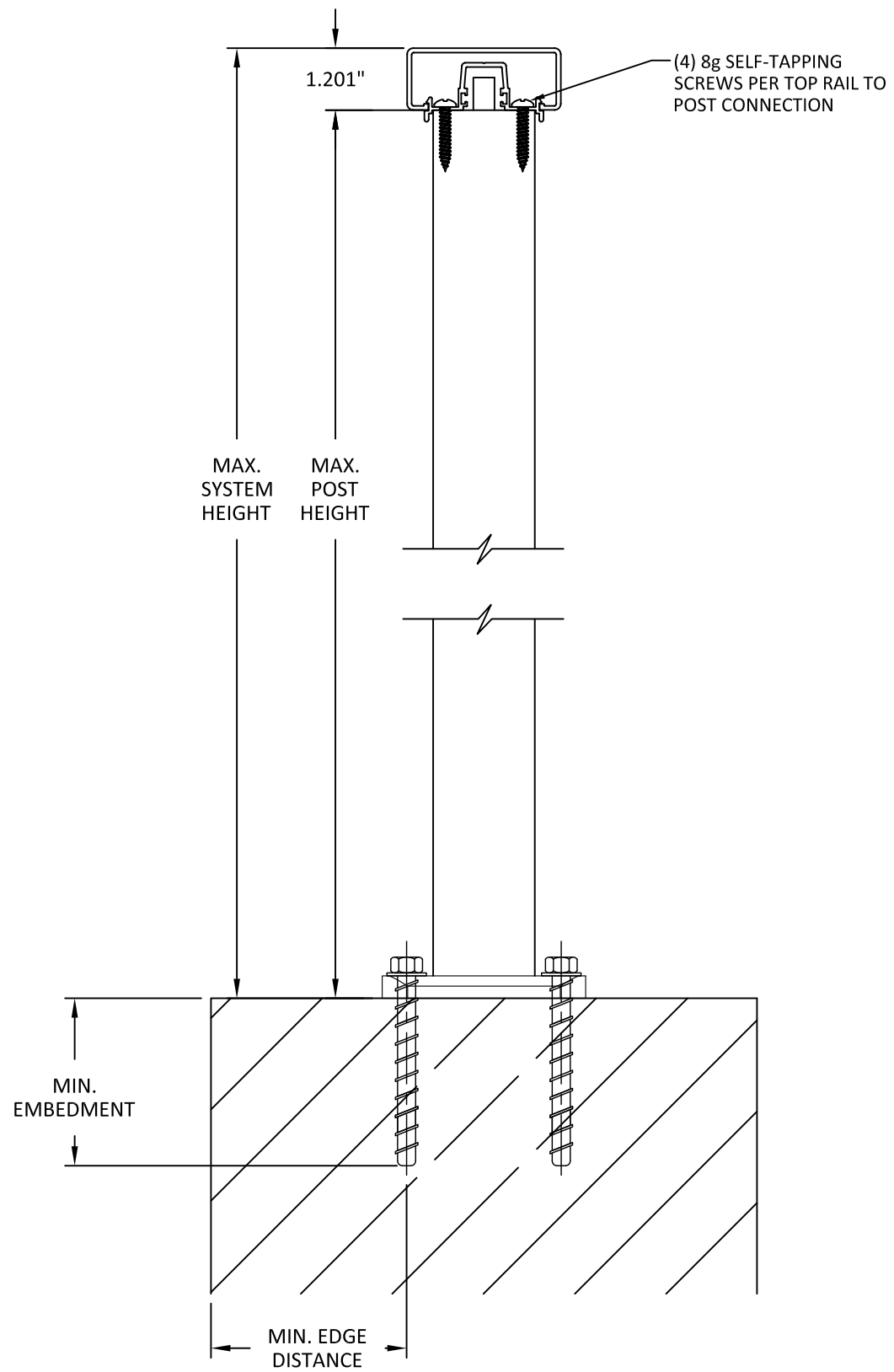

(4) 8g SELF-TAPPING SCREWS PER TOP RAIL TO POST CONNECTION

ANCHOR SCHEDULE						
OPTION	ANCHOR TYPE	BRAND	SUBSTRATE	EMBEDMENT (IN)	EDGE DISTANCE (IN)	ANCHOR QUANTITY
A	WOOD	5/16" LAG SCREW	0.55 S.G.	1.5000	0.7500	4
B		3/8" LAG SCREW	0.55 S.G.	1.5000	0.7500	4
C		1/2" LAG SCREW	0.55 S.G.	1.5000	0.7500	4
D	STEEL	5/16" SELF-TAPPING SCREW	45000 PSI	3 THREADS	0.5000	4
E		3/8" SELF-TAPPING SCREW	45000 PSI	3 THREADS	0.5000	4
F		1/2" SELF-TAPPING SCREW	45000 PSI	3 THREADS	0.5000	4
G	CONCRETE	1/4" DEWALT SCREW-BOLT+	3000 PSI	2.5000	3.0000	4
H		3/8" DEWALT SCREW-BOLT+	3000 PSI	2.5000	3.0000	4
I		1/2" DEWALT SCREW-BOLT+	3000 PSI	2.5000	3.0000	4

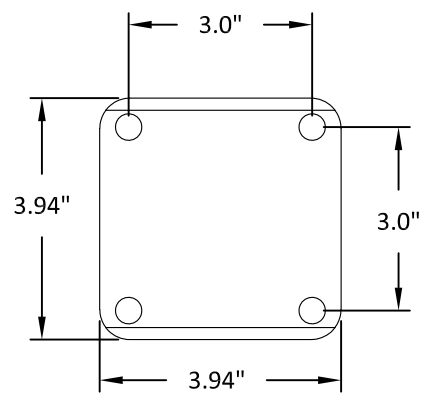

BASE PLATE TOP VIEW

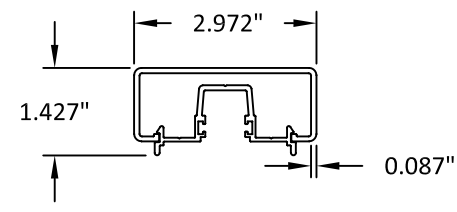

GSW005/006 TOP RAIL:
 • MAX. SPAN: 7.33 FT

FUTUREGLASS
 GLASSWAREHOUSE
 FUTUREGLASS
 GLASS WAREHOUSE
 1319 ROCKY POINT DRIVE, SUITE 200
 OCEANSIDE, CA 92056

TITLE: **FABRIKASI POSTED GLASS RAILING SYSTEM**
 ANCHOR SCHEDULE & INSTALLATION DETAIL

PREPARED BY:
BUILDING DROPS, INC.
 1900 NE MIAMI COURT, STE. 2-15
 MIAMI, FL 33132
 PH: (954)399-8478
 FAX: (954)744-4738
 WEB: www.buildingdrops.com



REMARKS	BY	DATE
DRAWING FORMAT UPDATE	DI	11/2024

THE INSTALLATION DETAILS DESCRIBED HEREIN ARE GENERIC AND MAY NOT REFLECT ACTUAL CONDITIONS FOR A SPECIFIC SITE. IF SITE CONDITIONS CAUSE INSTALLATION TO DEVIATE FROM THE REQUIREMENTS DETAILED HEREIN, A LICENSED ENGINEER OR ARCHITECT SHALL PREPARE SITE SPECIFIC DOCUMENTS FOR USE WITH THIS DOCUMENT.

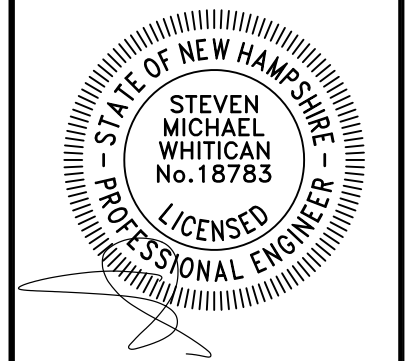

BUILDING DROPS, INC
 1900 NE MIAMI COURT, STE. 2-15
 MIAMI, FL 33132
 FBPE CERT. OF AUTHORIZATION No. 29578

DATE: **07.30.2024**
 DWG. BY: **SH** CHK. BY: **HFN**
 SCALE: **NTS**
 DWG. #: **GLW001**

SHEET:
5
 OF 8

ALLOWABLE ANCHOR WIND LOAD TABLES

ANCHOR TYPE G

ALLOWABLE ANCHOR WIND LOAD (PSF)								
POST HEIGHT (IN.)	POST SPACING (IN.)							
	36	42	48	54	60	66	72	78
36	43.6	37.4	32.7	29.1	26.2	23.8	21.8	20.1
42	32.0	27.5	24.0	21.4	19.2	17.5	16.0	14.8
48	24.5	21.0	18.4	16.3	14.7	13.4	12.3	11.3
54	19.4	16.6	14.5	12.9	11.6	10.6	9.7	8.9
60	15.7	13.5	11.8	10.5	9.4	8.6	7.8	7.2

ANCHOR TYPES: B, E, & H

ALLOWABLE ANCHOR WIND LOAD (PSF)								
POST HEIGHT (IN.)	POST SPACING (IN.)							
	36	42	48	54	60	66	72	78
36	56.7	48.6	42.5	37.8	34.0	30.9	28.4	26.2
42	41.7	35.7	31.2	27.8	25.0	22.7	20.8	19.2
48	31.9	27.3	23.9	21.3	19.1	17.4	15.9	14.7
54	25.2	21.6	18.9	16.8	15.1	13.7	12.6	11.6
60	20.4	17.5	15.3	13.6	12.2	11.1	10.2	9.4

ANCHOR TYPES: A & D

ALLOWABLE ANCHOR WIND LOAD (PSF)								
POST HEIGHT (IN.)	POST SPACING (IN.)							
	36	42	48	54	60	66	72	78
36	48.4	41.5	36.3	32.3	29.1	26.4	24.2	22.4
42	35.6	30.5	26.7	23.7	21.4	19.4	17.8	16.4
48	27.3	23.4	20.4	18.2	16.4	14.9	13.6	12.6
54	21.5	18.5	16.1	14.4	12.9	11.7	10.8	9.9
60	17.4	14.9	13.1	11.6	10.5	9.5	8.7	8.0

ANCHOR TYPES: C, F, & I

ALLOWABLE ANCHOR WIND LOAD (PSF)								
POST HEIGHT (IN.)	POST SPACING (IN.)							
	36	42	48	54	60	66	72	78
36	70.4	60.4	52.8	47.0	42.3	38.4	35.2	32.5
42	51.8	44.4	38.8	34.5	31.1	28.2	25.9	23.9
48	39.6	34.0	29.7	26.4	23.8	21.6	19.8	18.3
54	31.3	26.8	23.5	20.9	18.8	17.1	15.7	14.4
60	25.4	21.7	19.0	16.9	15.2	13.8	12.7	11.7

FUTUREGLASS

GLASSWAREHOUSE

FUTUREGLASS
GLASS WAREHOUSE
1319 ROCKY POINT DRIVE, SUITE 200
OCEANSIDE, CA 92056

TITLE: FABRIKASI POSTED GLASS RAILING SYSTEM

ALLOWABLE ANCHOR WIND LOAD TABLES

PREPARED BY: BUILDING DROPS, INC.

1900 NE MIAMI COURT, STE. 2-15
MIAMI, FL 33132
PH: (954)399-8478
FAX: (954)744-4738
WEB: www.buildingdrops.com



REMARKS	BY	DATE
DRAWING FORMAT UPDATE	DI	11/2024

THE INSTALLATION DETAILS DESCRIBED HEREIN ARE GENERIC AND MAY NOT REFLECT ACTUAL CONDITIONS FOR A SPECIFIC SITE. IF SITE CONDITIONS CAUSE INSTALLATION TO DEVIATE FROM THE REQUIREMENTS DETAILED HEREIN, A LICENSED ENGINEER OR ARCHITECT SHALL PREPARE SITE SPECIFIC DOCUMENTS FOR USE WITH THIS DOCUMENT.

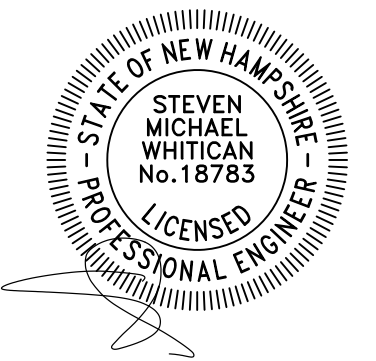

BUILDING DROPS, INC
1900 NE MIAMI COURT, STE. 2-15
MIAMI, FL 33132
FBPE CERT. OF AUTHORIZATION No. 29578

DATE:	07.30.2024
DWG. BY:	SH
CHK. BY:	HFN
SCALE:	NTS
DWG. #:	GLW001
SHEET:	6
	OF 8

TYP. ALLOWABLE WIND LOADS

ALLOWABLE WIND LOADS (PSF)						
WIND SPEED (MPH)	W _{ASD} FOR Cf = 1.3			W _{ASD} FOR Cf = 2.6		
	EXP. B K _z = 0.7	EXP. C K _z = 0.85	EXP. D K _z = 1.03	EXP. B K _z = 0.7	EXP. C K _z = 0.85	EXP. D K _z = 1.03
100	9.50	11.53	13.98	19.00	23.07	27.95
110	11.49	13.95	16.91	22.98	27.91	33.82
120	13.68	16.61	20.12	27.35	33.21	40.25
130	16.05	19.49	23.62	32.10	39.98	47.24
140	18.62	22.60	27.39	37.23	45.21	54.78
150	21.37	25.95	31.44	42.74	51.90	62.89
160	24.31	29.52	35.78	48.63	59.05	71.55
170	27.45	33.33	40.39	54.90	66.66	80.78
180	30.77	37.37	45.28	61.54	74.73	90.56

PREMISES FOR WIND LOADS:

1. WIND LOADS ARE BASED ON ASCE 7.
2. THE FOLLOWING ASSUMPTIONS HAVE BEEN MADE:
 - a. K_d = 0.85
 - b. K_zt = 1.0
 - c. MAX. HEIGHT, Z = 15 FT
3. C_f VALUES SHOWN ON TABLE ARE TWO OF THE TYPICAL EXTREME VALUES. FOR OTHER C_f VALUES MULTIPLY THE WIND LOAD BY C_f/1.3 OR REFER TO ASCE 7 FOR MORE DETAILS.
4. FOR HEIGHTS ABOVE 15 FT REFER TO ASCE 7 FOR ADDITIONAL FACTORS.
5. WIND LOADS DISPLAYED ARE GENERIC AND MAY NOT REFLECT THE JOBSITE CONDITIONS. IF SITE SPECIFIC WIND LOADS ARE REQUIRED A LICENSED ENGINEER SHALL PREPARE SITE SPECIFIC WIND LOADS FOR USE WITH THIS PRODUCT.
6. REFER TO SHEET 8 FOR A RISK CATEGORY II WIND SPEED MAP PER ASCE 7.

FUTUREGLASS

GLASSWAREHOUSE

FUTUREGLASS
GLASS WAREHOUSE
1319 ROCKY POINT DRIVE, SUITE 200
OCEANSIDE, CA 92056

TITLE: FABRIKASI POSTED GLASS RAILING SYSTEM
ALLOWABLE WIND LOADS PER ASCE 7
PREPARED BY: BUILDING DROPS, INC.
1900 NE MIAMI COURT, STE. 2-15
MIAMI, FL 33132
PH: (954)399-8478
FAX: (954)744-4738
WEB: www.buildingdrops.com



REMARKS	BY	DATE
DRAWING FORMAT UPDATE	DI	11/2024

THE INSTALLATION DETAILS DESCRIBED HEREIN ARE GENERIC AND MAY NOT REFLECT ACTUAL CONDITIONS FOR A SPECIFIC SITE. IF SITE CONDITIONS CAUSE INSTALLATION TO DEVIATE FROM THE REQUIREMENTS DETAILED HEREIN, A LICENSED ENGINEER OR ARCHITECT SHALL PREPARE SITE SPECIFIC DOCUMENTS FOR USE WITH THIS DOCUMENT.

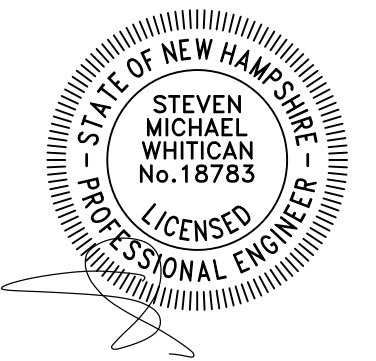

BUILDING DROPS, INC
1900 NE MIAMI COURT, STE. 2-15
MIAMI, FL 33132
FBPE CERT. OF AUTHORIZATION No. 29578

DATE:	07.30.2024	
DWG. BY:	SH	CHK. BY: HFN
SCALE:	NTS	
DWG. #:	GLW001	
SHEET:	7 OF 8	

c:\users\y\manwata\building_drops\inc\building_drops_projects\glass_warehouse\lc\ecv-24-0946.1 - engineering evaluation - base shoe system and posted glass railing\dwgs\post_rail\other states\glw001.dwg 1/30/2025 12:18 PM

WIND SPEED MAP

mph (m/sec.)

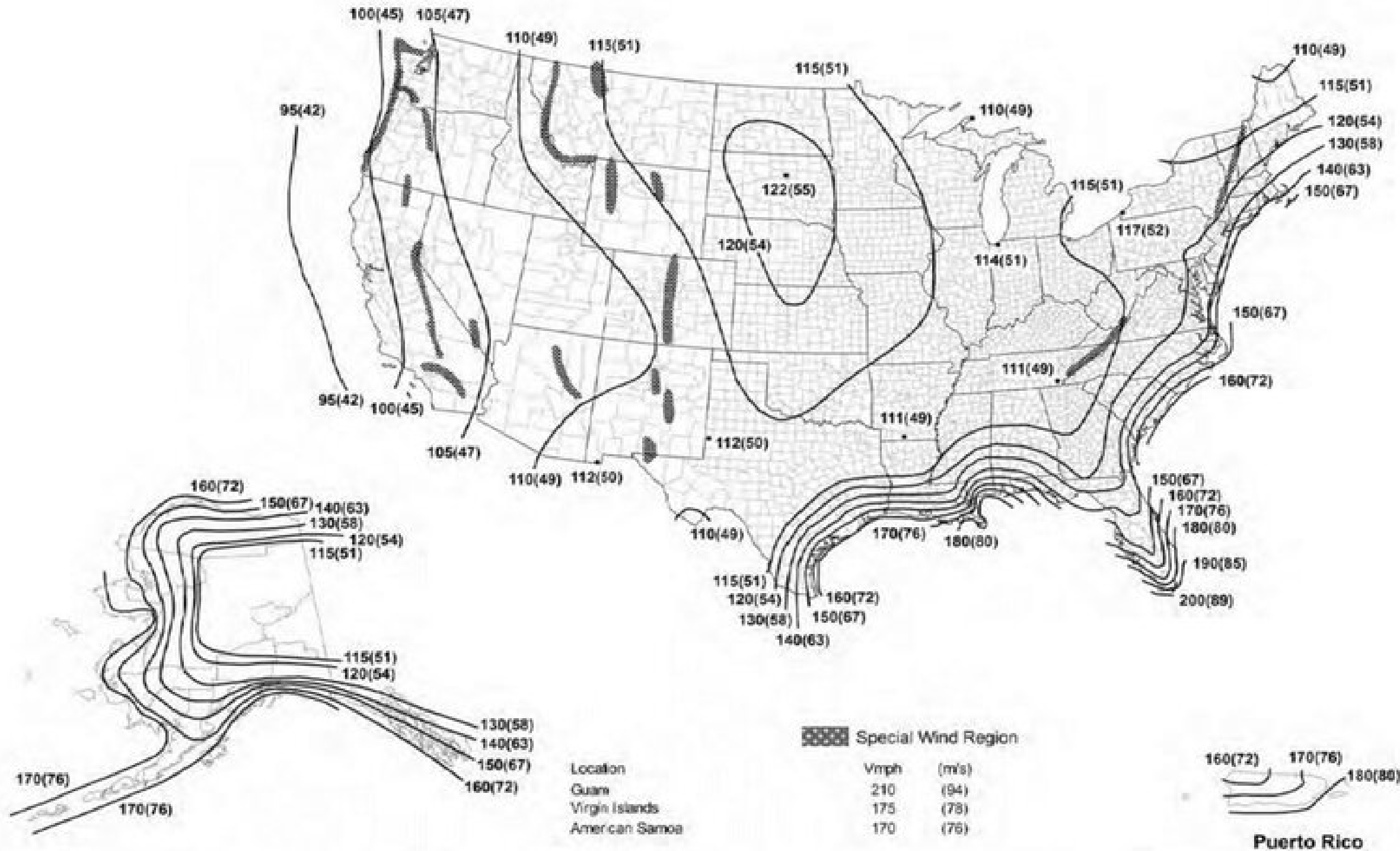

FUTUREGLASS

GLASSWAREHOUSE

FUTUREGLASS
GLASS WAREHOUSE
1319 ROCKY POINT DRIVE, SUITE 200
OCEANSIDE, CA 92056

TITLE: FABRIKASI POSTED GLASS RAILING SYSTEM

WIND SPEED MAP

PREPARED BY: BUILDING DROPS, INC.

1900 NE MIAMI COURT, STE. 2-15
MIAMI, FL 33132
PH: (954)399-8478
FAX: (954)744-4738
WEB: www.buildingdrops.com



REMARKS	BY	DATE
DRAWING FORMAT UPDATE	DI	11/2024

THE INSTALLATION DETAILS DESCRIBED HEREIN ARE GENERIC AND MAY NOT REFLECT ACTUAL CONDITIONS FOR A SPECIFIC SITE. IF SITE CONDITIONS CAUSE INSTALLATION TO DEVIATE FROM THE REQUIREMENTS DETAILED HEREIN, A LICENSED ENGINEER OR ARCHITECT SHALL PREPARE SITE SPECIFIC DOCUMENTS FOR USE WITH THIS DOCUMENT.

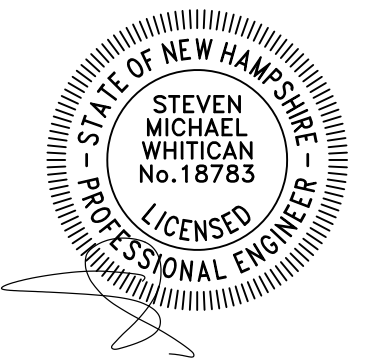

BUILDING DROPS, INC
1900 NE MIAMI COURT, STE. 2-15
MIAMI, FL 33132
FBPE CERT. OF AUTHORIZATION No. 29578

DATE:	07.30.2024	
DWG. BY:	SH	CHK. BY: HFN
SCALE:	NTS	
DWG. #:	GLW001	

SHEET:
8
OF 8