

SIDES	BOTTOM
4 PCS #1/4-24×3/8 Screws Installed	
Material:Steel-Welding tube, zinc plated	

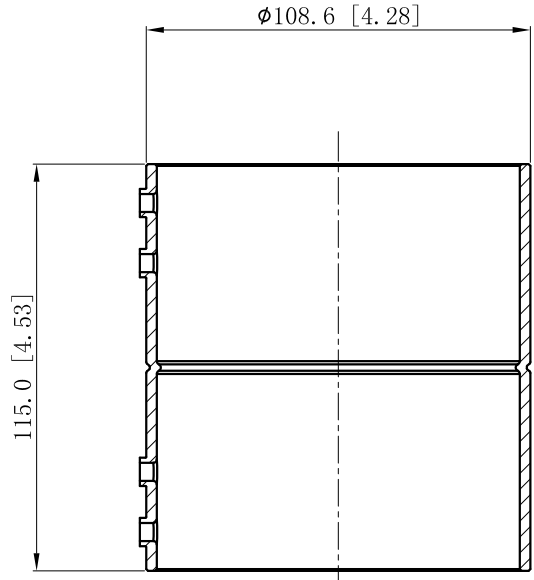

CUTAWAY VIEW A-A

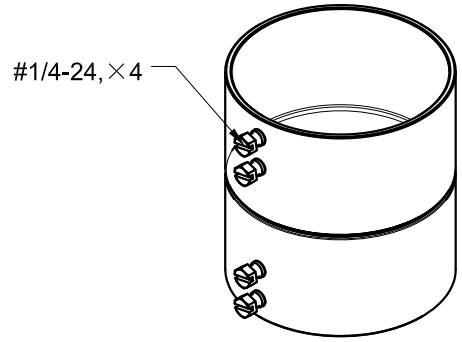
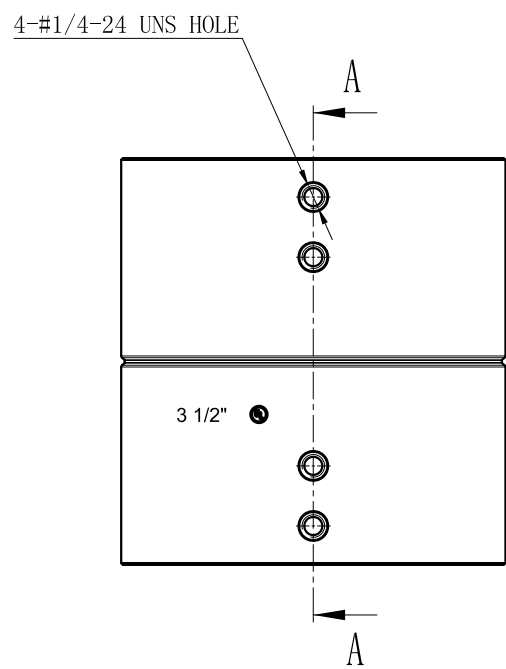

DESCRIPTION
TRADE REFERENCE TERMS

STANDARD PACKING
5 PCS

This data sheet is for reference only .GARVIN INDUSTRIES reserves the right to make changes to the design without prior notice.

GARVIN INDUSTRIES		
TITLE STEEL EMT SET SCREW COUPLINGS		
SIZE A4	DWG NO. SSCP-350	REV
DATA SHEET		