







Assembly Instructions, #10434 Delton Drawer Console Table

| | |
|---------------------|--|
| A: Top Assembly |  |
| B: (4) Legs |  |
| C: Base Assembly |  |
| D: (8) Bolts |  |
| E: (8) Flat Washers |  |
| F: (8) Lock Washers |  |
| G: Allen Wrench |  |

Step 1

Place table upside down on a soft surface. Fasten the legs with (4) bolts, flat washers and lock washers using the Allen wrench. Do not tighten yet.

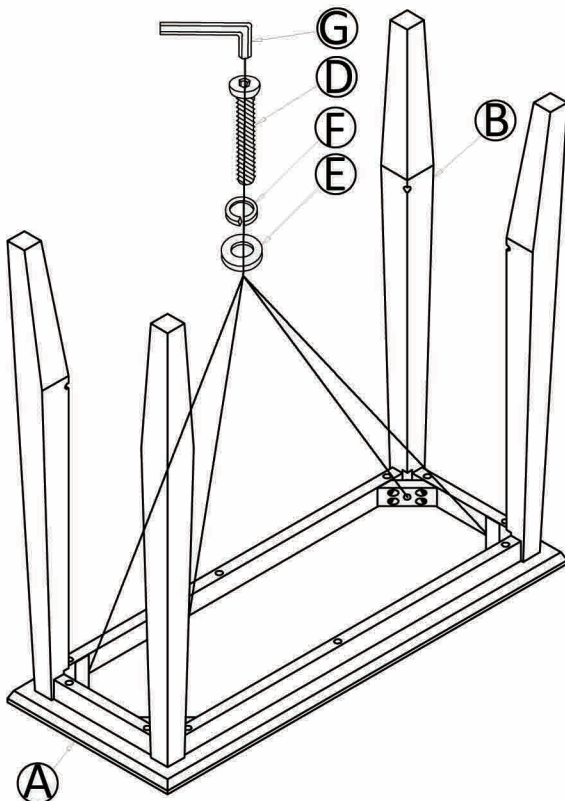

Step 2

Fasten the Base Assembly to the legs with (4) bolts and flat washers and lock washers, tighten bolts. Ask for another set of hands to help hold the Base Assembly while the bolts are inserted. Now tighten these bolts and the other bolts in step 1.

