

EHF

ASSEMBLY INSTRUCTIONS

Linen Towel

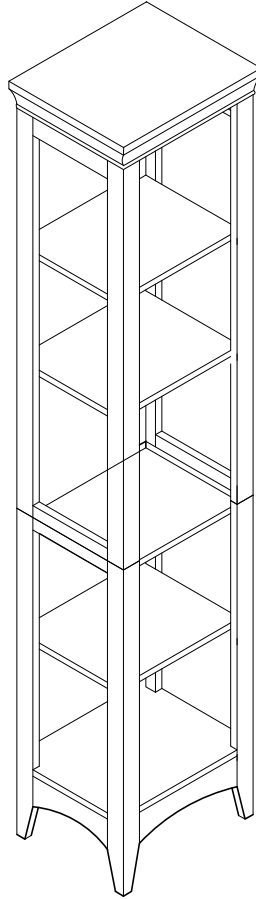

Please provide the following information when contacting for parts or questions: the name of the company you purchased from, the UPS/FedEx tracking number.

This product comes with a 1 year warranty. Products purchased second hand/used are not covered under the warranty.

ASSEMBLY INSTRUCTIONS-IMPORTANT

Carefully unpack & identify each component before attempting to assemble. Refer to parts list. Please take care when assembling the unit and always set the parts on a clean, soft surface. If you require any assistance with assembly, parts, please call the company you place order with or please email to: service@eleganthf.net

INSTRUCCIONES PARA ARMAR-IMPORANT:







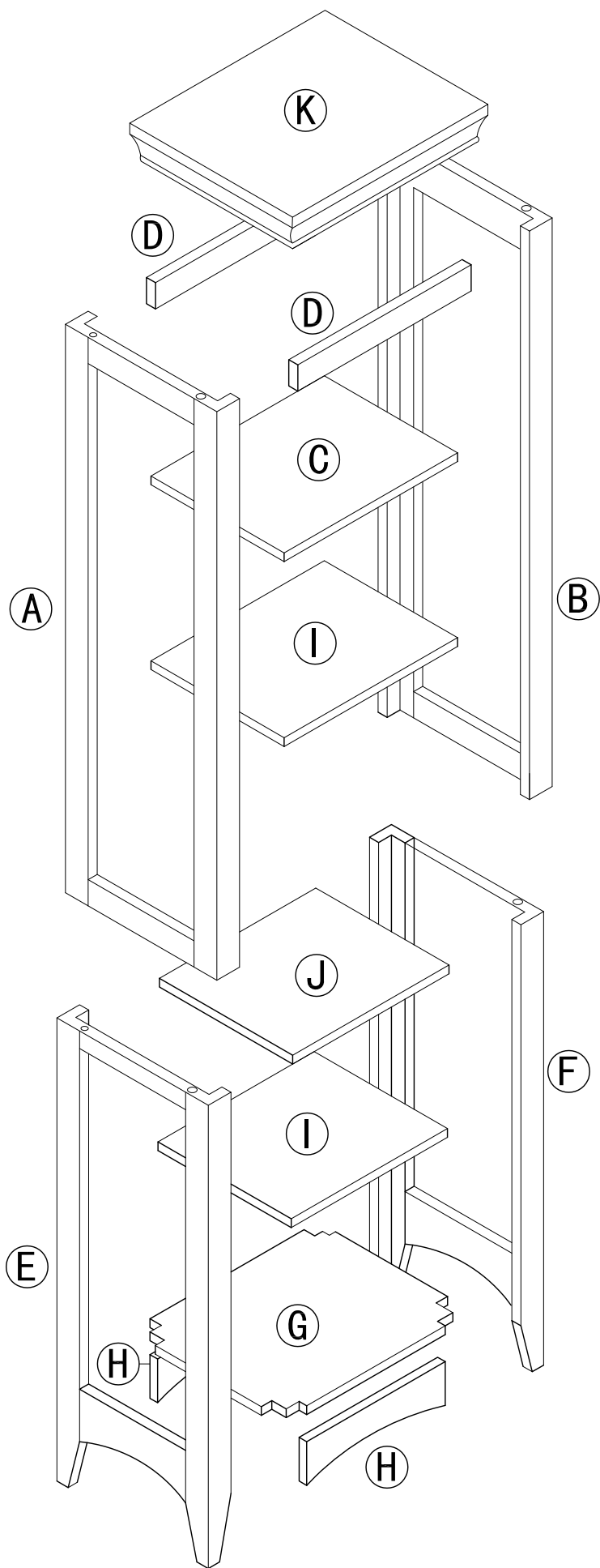

Desempaque cuidadosamente e identifique cada componente antes de tartar de empezar su ensambladura. Verifique la lista de partes. Por favor tenga cuidado cuando arme la unidad y siempre coloque las piezas sobre una superficie plana, suave y limpia. Si necesita ayuda con el armado, envíe un correo electzórico a service@eleganthf.net

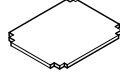
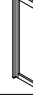
DIRECTIVES DE MONTAGE-IMPORTANT:

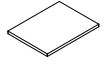

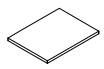

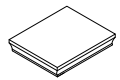

Avant de commencer l' assemblage, déballez délicatement toutes les pièces et repérez-les sur la liste des pièces. Procédez avec soins durant l' assemblage et posez toujours les pièces sur une surface proper, douce et lisse. sie vouo plait e-mail á service@eleganthf.net

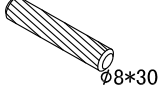

COMPONENTS

PART	FIGURE	DESCRIPTION	QTY	PART	FIGURE	DESCRIPTION	QTY
A		UPPER LEFT SIDE FRAME	1PC	G		BOTTOM PANEL	1PC
B		UPPER RIGHT SIDE FRAME	1PC	H		BOTTOM RAIL	2PCS
C		UPPER FIXED SHELF	1PC	I		MIDDLE FIXED SHELF	2PCS
D		UPPER RAIL	2PCS	J		BOTTOM FIXED SHELF	1PC
E		BOTTOM LEFT SIDE FRAME	1PC	K		TOP PANEL	1PC
F		BOTTOM RIGHT SIDE FRAME	1PC				

HARDWARE & TOOLS

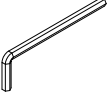
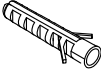
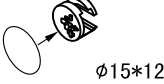
PART	FIGURE	DESCRIPTION	QTY	PART	FIGURE	DESCRIPTION	QTY
1		WOODEN DOWEL	36PCS	6		SCREW	2 PCS
2		CAM BOLT	16PCS	7		FIX BELT	1 PC
3		SMALL CAM LOCK	12PCS	8		WASHER	2 PCS
4		HEX BOLT	8 PCS	9		ALLEN WRENCH	1 PC
5		ANCHOR	1 PC	10		BIG CAM LOCK	4 PCS

TOOL NEEDED:



**PHILIPS SCREWDRIVER REQUIRED
- NOT INCLUDED**

SUGGESTION:



TWO PEOPLE FOR ASSEMBLING



WARNINGS:

1. DO NOT LET ANY SHARP OBJECTS TOUCH OR RUB THE SURFACE OF THE PRODUCT.
2. WHEN ASSEMBLING, DO NOT LET CHILDREN PLAY AROUND THE WORKING AREA.
3. PLEASE CONFIRM ALL PARTS ARE CORRECT BEFORE STARTING THE ASSEMBLY PROCESS.
4. DO NOT TIGHTEN ALL BOLTS AND SCREWS COMPLETELY UNTIL THE ENTIRE UNIT HAS BEEN ASSEMBLED AND SET UP.

1



12 PCS

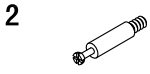

4 PCS

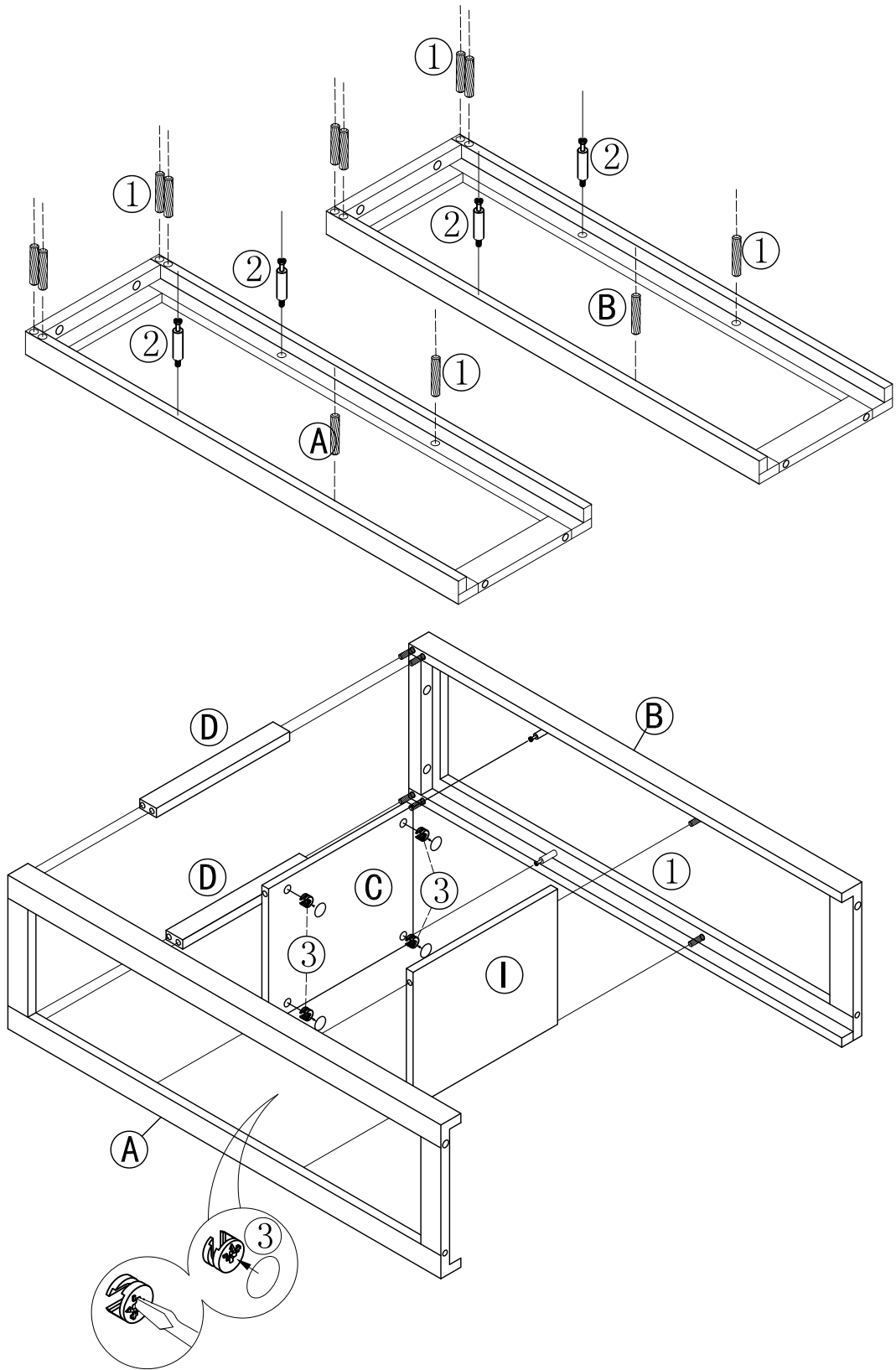
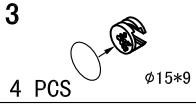

STEP 1:

1. Screw cambolts (2) and insert dowels (1) into panels A & B.
2. Connect rails Ds and shelves C & I to panels A & B and secure the shelves with camlocks (3).

2



4 PCS



4 PCS

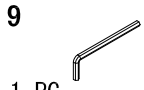

1 PC

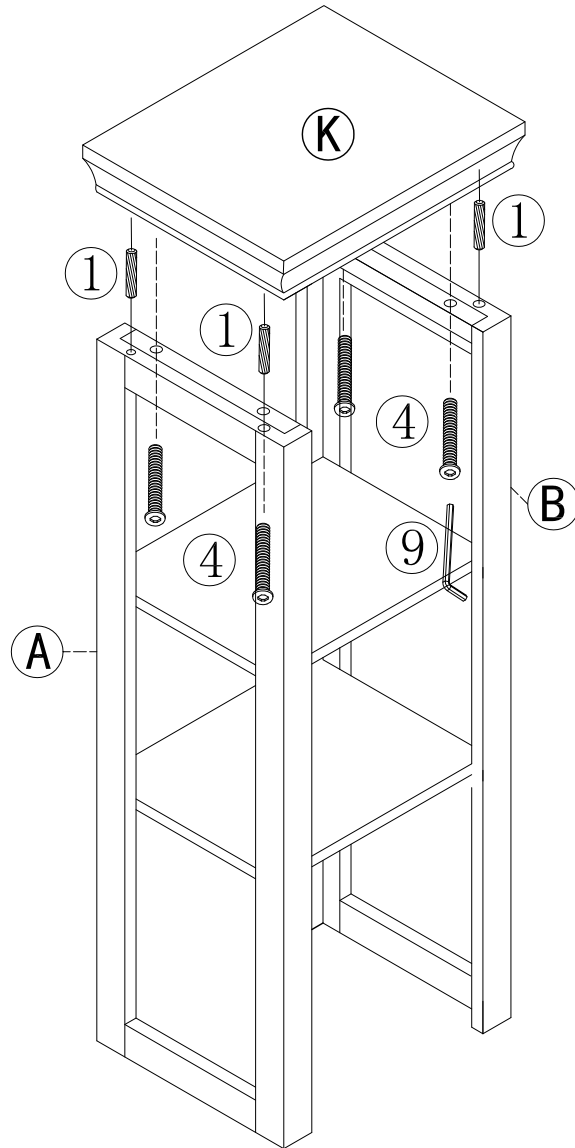

STEP 2:

1. Insert dowels (1) on the tops of panels A & B.
2. Attach panel K to panels A & B and secure with bolts (1).

3



16 PCS

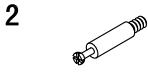

12 PCS

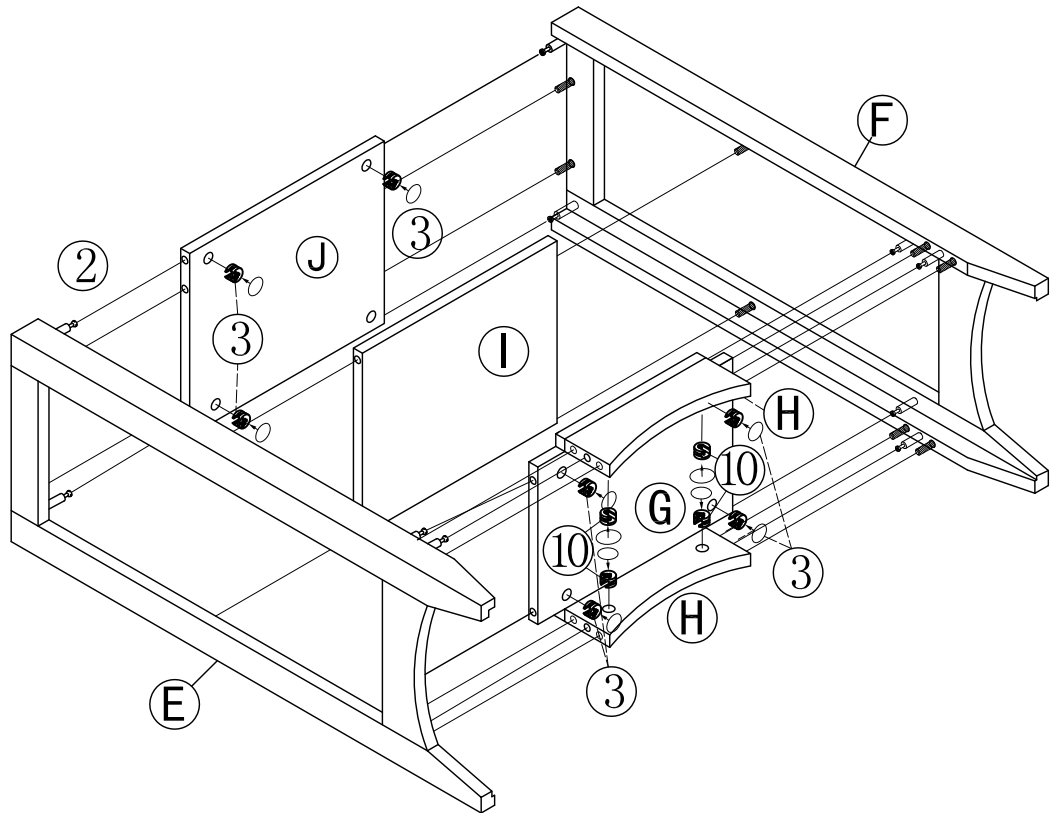
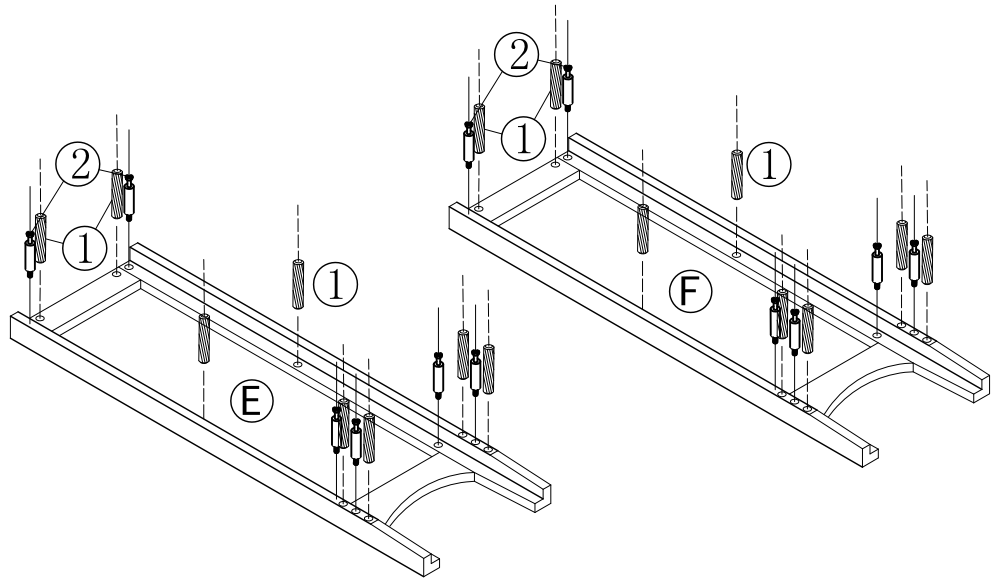
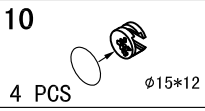
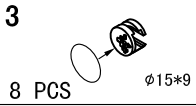

STEP 3:

1. Screw cambolts (2) and insert dowels (1) into panels E & F.
2. Connect rails Hs and shelves G, I, & J to panels E & F and secure shelves G & J and rails Hs with camlocks (3).

4



4 PCS



4 PCS

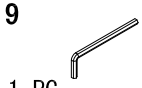

1 PC

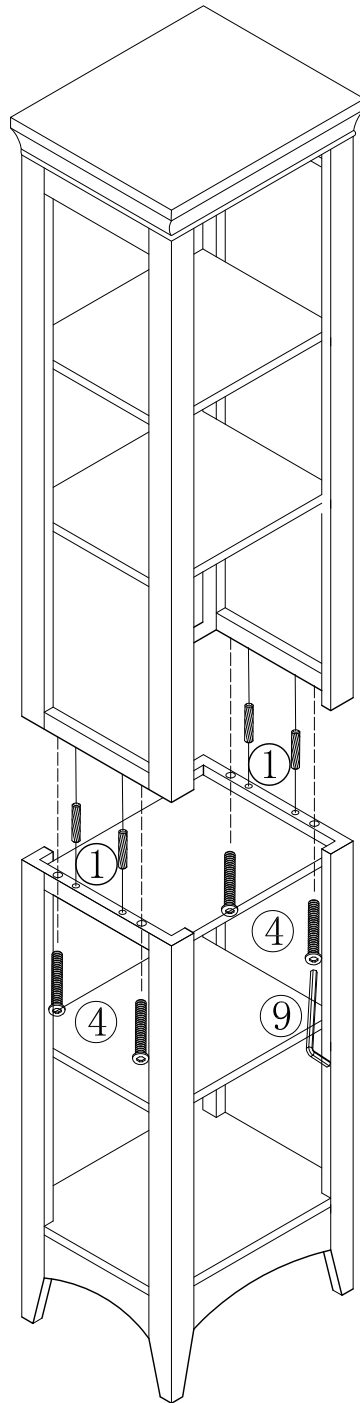

STEP 4:

1. Insert dowels (1) on the tops of panels E & F.
2. Connect the two halves of the cabinet and secure with bolts (4).

5

5



1 PC

6



2 PCS $\phi 4 \times 25$

7



1 PC

8



2 PCS

