

# MERCURY ELECTRONIC DARTBOARD



## Replacement Parts

Order direct at [www.gldproducts.com](http://www.gldproducts.com)  
or call our Customer Service department at  
**(800) 225-7593**  
8 am to 4:30 pm Central Standard Time

**Staple your receipt here.**

**Important:** A copy of your receipt will be needed to activate your warranty (see page 39).

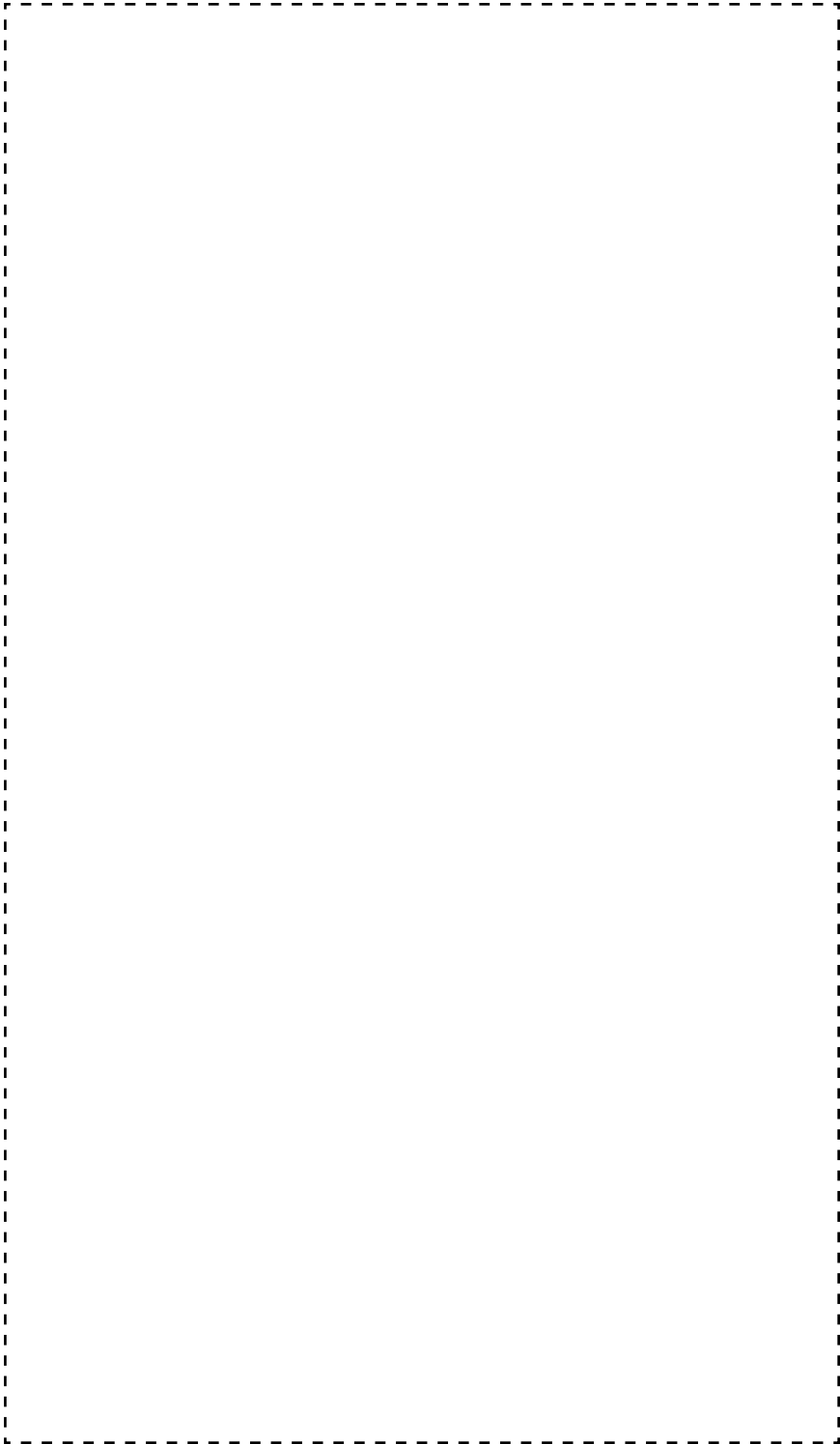

***Congratulations and THANK YOU for purchasing the Mercury Dartboard. You have chosen a product that should provide years of entertainment. To assist you with customer service and warranty claims, staple your receipt to the inside cover, then keep this manual in a safe place for future reference.***

**GLD Products**

S84 W19093 Enterprise Drive  
Muskego, WI 53150 USA  
1-800-225-7593  
Fax: 1-800-841-6944  
Email: [gld@gldmfg.com](mailto:gld@gldmfg.com)  
Web: [www.gldproducts.com](http://www.gldproducts.com)

This manual may have been updated. For the latest manual visit the GLD products website.



Place your package near the location where it will be used. Carefully unpack all components and verify you have all the correct pieces.

If you notice missing or defective parts, please call us at:  
**1-800-225-7593**



Please read and understand all instructions before beginning assembly.

**This assembly will require 2 adults.**



**Choking Hazard**

This game has small parts that may break free and present a choking hazard. Children should be supervised by an adult when playing this game.

**IF YOU HAVE A WARRANTY CLAIM, CALL US FIRST:**

Please refer to page 39.

**GLD Products**

Available 8 am to 4:30 pm Central Standard Time

S84 W19093 Enterprise Drive

Muskego, WI 53150 USA

1-800-225-7593

Fax: 1-800-841-6944

Email: [gld@gldmfg.com](mailto:gld@gldmfg.com)

Web: [www.gldproducts.com](http://www.gldproducts.com)

For all claims, please have your receipt and item number when you call. The product item number can be found on the front cover.

**If you are instructed to return the product for service, you are responsible for shipping the unit at your expense.**

**PRODUCT REGISTRATION**

**Important: The product registration form on page 41 and a copy of your receipt must be completed and returned within 10 days of purchase to validate your warranty.**

Online registration is also available. Go to [www.gldproducts.com/index.php/registration](http://www.gldproducts.com/index.php/registration) or click on this link. Follow the online instructions.



**WARNING: Parents** - Please read instructions carefully. Not for use by children without adult supervision.

Thank you for purchasing the GLD Mercury Dartboard. The computerized scoring system makes game playing easy and enjoyable. With 34 games to choose from, beginners and more advanced players will find challenging games to suit them.

**TOOLS REQUIRED**

- Tape measure
- Nail or marker
- Phillips screwdriver
- Level
- Mounting hardware

## UNPACKING THE GAME

After unpacking the game, it is important to save the original box, all packing material, and the receipt. These items will be needed if it ever proves necessary to return the game for service.

## MOUNTING (PHYSICAL INSTALLATION)

Two methods for mounting the dartboard are available.

1. Use the keyhole slots on the backside of the dartboard. Follow the illustration and mount the dartboard. The two screws are screwed into the wall until the screw head is 3/8" away from the wall. The dartboard is positioned so the two screw heads are inside the keyhole. Slide the dartboard down to secure.
2. Four holes are accessible from the front to drive in screws. With the dartboard held in place, four screws are driven in from the front, through the existing holes. Use 1/8" diameter screws. The head of the screw must fit inside the pocket.

### Wall Anchors

A wall with studs is the most common type of wall to mount the dartboard.

1. Locate a stud and use wood screws or sheet metal type screws to secure the dartboard.
2. If a stud cannot be located or is not in the proper location, use an anchor that is suitable for the type of wall.

Some common anchors are:

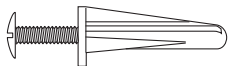

**Plastic** - Drill a snug hole in drywall and push the anchor in up to the head. When the screw is screwed into the anchor, the plastic will expand, locking the anchor in place. Do not use on thin panelling.

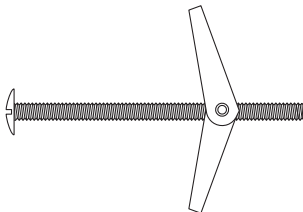

**Toggle Bolt** - Drill hole through wall. Hole must be large enough for the wings to pass through. Insert screw through the holes in the dartboard and thread the toggle wings just onto the screw. Fold the wings back and push through the hole until the wings spring open. Pull back on the screw to hold wings against the inside of the wall and tighten screw.

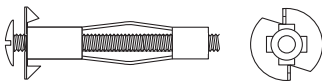

**Hollow wall anchor** - Drill a snug hole through the wall. Tap anchor into the hole until the prongs on the underside of the head are seated securely into the wall. Turn screw in and apply pressure to keep the anchor head from turning. Tighten screw until resistance is felt. Do not over tighten. Turn screw out to remove. Anchor will stay and screw can be replaced.

Other methods are available. Consult a hardware store if questions arise.

**Mounting Using the Keyhole Slots**

Refer to the illustrations on the following pages.

1. Choose a location that is near an electrical outlet and has at least 10 feet of open floor space in front of the board. Locate and use a wall stud for mounting whenever possible.
2. Locate studs and use wood screws or sheet metal screws to secure the dartboard if the mark is on the stud.
3. Determine the location for the dartboard. Place a mark on the wall 68" (172.7 cm) from the floor. This mark is the final position of the center of the dartboard (bullseye).
4. If the mark is not over a stud, use the mounting hardware that came with your dartboard.
5. Measure 9" (22.8 cm) directly up from the bullseye mark and place a first mark on the wall. Then measure to the left and to the right 7.875" (20 cm) from the first mark and place second and third marks on the wall. Use a level to check that all marks are horizontal.
6. Drill pilot holes at the second and third marks. These are for the mounting screws.
7. If using wall anchors, follow the instructions under Wall Anchors on page 5.
8. Insert screws into anchors until a 1/4" (6.5 mm) gap is left between the wall and the screw head.
9. Hold the dartboard so the two screw heads fit into the lower part of the keyholes. The dartboard should slide down 1/2" and the screw heads will hold it on the wall.
10. Screws can be tightened or loosened to provide a secure mounting.

**Mounting Using the Four Holes From the Front**

Refer to the illustrations on the following pages.

1. Choose a location that is near an electrical outlet and has at least 10 feet of open floor space in front of the board. Locate and use a wall stud for mounting whenever possible.
2. Two people are needed for this step. Hold board on the wall. Position center of bullseye 68" from the floor. Level the board. Hold in place.
3. Locate the four mounting holes on the front of the board. Use a marker or nail to mark the position of the board through the four mounting holes onto the wall. Remove the board.
4. Drill four pilot holes on the marks created in Step 3.
5. If using plastic anchors: drill the holes so the anchors fit snugly. Push anchors into place.
6. Line up dartboard over anchors. Screw board into place. The screws will expand the anchors.

**Create the Toe Line**

Place a toe line 96" from the face of the board for the throwing distance. Adhesive tape or masking tape, 2' long by 2-1/2" wide, may be used. GLD products offers a Viper Throwing Line and a Dart Mat for this purpose.

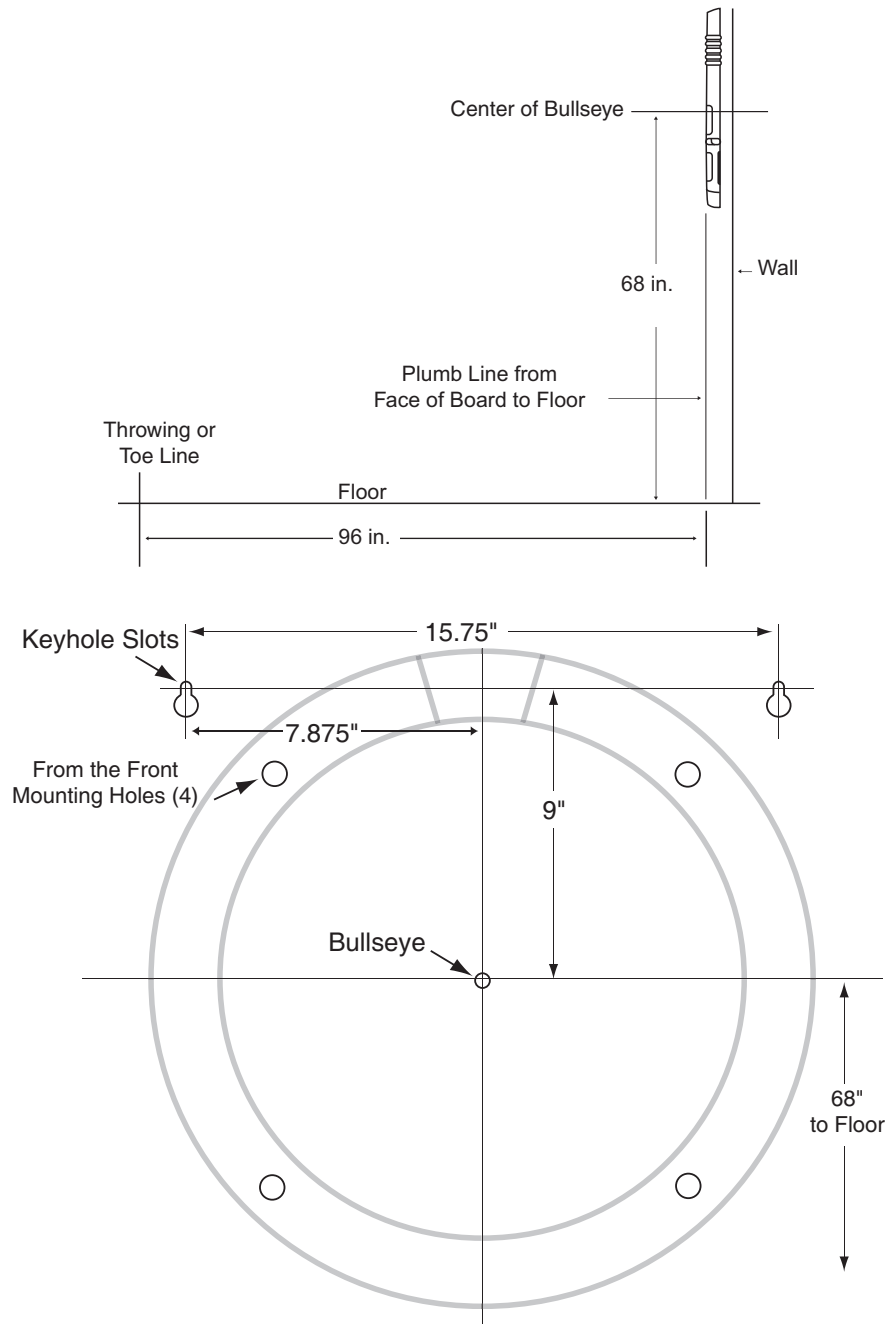

**POWER INSTALLATION**

The dartboard is designed to be powered by an AC adapter. The power supply must be AC to 5V DC, 1000 milliamp (minimum) adapter with the DC plug polarity configured as positive (+) outside and negative (-) inside. To connect the adapter, plug the DC plug into the DC power jack on the bottom of the dartboard and the AC plug into an electrical outlet.

1. The board is not intended for children under the age of 12 years old.
2. The board must only be used with the recommended transformer.
3. The transformer is not a toy.
4. Disconnect the dartboard from the transformer before cleaning.

**PROTECTIVE FILM**

This electronic dartboard may have a clear protective film over the entire display and button area to prevent scratching during shipping. It is recommended that you remove this film for easier reading of the display. To remove, simply lift edge, peel off and discard.



**WARNING: Not for use by children without adult supervision. Darts are not toys and may cause injury if used improperly. Everyone must stand behind the dart thrower.**



## IMPORTANT NOTES

1. Occasionally, a dart will cause a segment to become wedged within the segment separator web. If this happens, all games will be suspended and the display will indicate the segment number that is stuck.  
To free the segment, simply remove the dart or broken tip from the segment. If the problem is still not solved, try wiggling the segment until it is loose. The game will then resume where it left off.
2. From time to time a tip will break off and become stuck in the segment. Try to remove it with a pair of pliers or tweezers by grasping the exposed end and pulling it out of the segment. If this is not possible, you can attempt to push the tip through to the back of the segment. Use a nail that is smaller than the hole and gently push the tip until it falls through the other side. Be careful not to push too far and damage the circuitry behind the segment. Don't be alarmed if tips break. This is a normal occurrence when playing soft tip darts. We included a pack of replacement tips which should keep you supplied for quite some time. When replacing tips, make sure you use the same type of tips that come with this dartboard.
3. It is recommended that you use the enclosed darts on this dartboard. Using other darts may cause damage to the segment and electronic circuit. Replacement tips are available at most retailers carrying dart products.
4. This game is designed for use with 3/4" maximum length soft-tip darts only! Never use metal tipped darts or longer soft-tip darts on this dartboard! Metal tipped darts will seriously damage the circuitry, the computer, and electronic operation of the dartboard.
5. Electronic and mechanical reaction time is required between shots. If two shots occur too close together, pull out second dart and rethrow to properly record your score.
6. Use only the provided AC adapter. **Using the wrong adapter may cause electrical shock and damage to the unit.**
7. Do not use excessive force when throwing darts. Throwing a dart too hard will cause frequent tip breakage and cause excessive wear on the board.
8. Do not spill liquids on the dartboard. Do not use spray cleaners that contain ammonia or other harsh chemicals, as they may damage the dartboard. Instead, we suggest regular dusting with a damp cloth. Make sure the game is unplugged and use a mild detergent and a damp cloth for more vigorous cleaning.
9. This game is for indoor use only.

**Helpful Tip:** To prevent dart tips from loosening, twist the dart to the right (clockwise when pulling it from the board). This motion will make dart removal easier and will prolong the life of your dart tips.

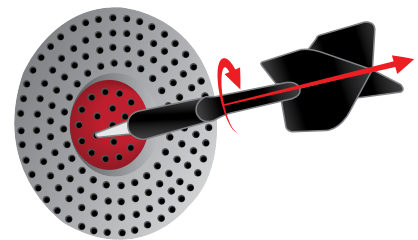

Segment Scoring	Scoring Rules
Single scoring segment	score times 1
Double scoring segment	score times 2
Triple scoring segment	score times 3
Outer bullseye	25 times 1
Center bullseye	25 times 2

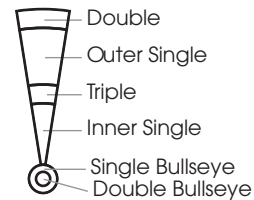

**QUICK START - IF YOU JUST WANT TO START THROWING DARTS**

1. Turn game on by pressing the POWER button.

**Note:** Pressing the PAGE UP or PAGE DOWN buttons will change the game.

2. Press the GAME button. The top left display will show G01. The default game is G01 301 with 2 players.

3. Press the START/NEXT Player button to begin the game.

4. Start throwing darts. When the player gets their score down to exactly 301 the game is over.

**DARTBOARD GAME MENU**

Game	Name	Optional Team Play	Players	In/Out Single/DBL/Master	Options
G01	301 (501, 601, 701, 801, 901)	Yes	1-8	Yes	6
G02	Cricket (and No-Score Cricket)	Yes	1-8	N/A	2
G03	Scram	No	1-2	N/A	N/A
G04	Cut-Throat Cricket	Yes	1-8	N/A	N/A
G05	English Cricket	No	1-2	N/A	N/A
G06	Advanced Cricket	Yes	1-8	N/A	N/A
G07	Shooter	Yes	1-8	N/A	7
G08	Big Six	Yes	1-8	N/A	5
G09	Overs	Yes	1-8	N/A	5
G10	Unders	Yes	1-8	N/A	5
G11	Count-Up	Yes	1-8	Yes	8
G12	High Score	Yes	1-8	Yes	12
G13	Round-The-Clock	Yes	1-8	N/A	12
G14	Killer	Yes	1-8	N/A	11
G15	Double Down	Yes	1-8	N/A	N/A
G16	Forty One	Yes	1-8	N/A	N/A
G17	All Fives	Yes	1-8	N/A	5

<b>Game</b>	<b>Name</b>	<b>Optional Team Play</b>	<b>Players</b>	<b>In/Out Single/DBL/Master</b>	<b>Options</b>
G18	Shanghai	Yes	1-8	N/A	8
G19	Golf	Yes	1-8	N/A	10
G20	Football	Yes	1-8	N/A	N/A
G21	Baseball	Yes	1-8	N/A	4
G22	Steeplechase	Yes	1-8	N/A	N/A
G23	Bowling	Yes	1-8	N/A	6
G24	Car Rallying	Yes	1-8	N/A	N/A
G25	Shove A Penny	Yes	1-8	N/A	N/A
G26	Nine-Dart Century	Yes	1-8	Yes	N/A
G27	Green Vs. Red	No	1-2	N/A	N/A
G28	Gold Hunting	Yes	1-8	N/A	12
G29	Elimination	Yes	1-8	N/A	3
G30	Horseshoes	No	1-2	N/A	11
G31	Battleground	No	1-2	N/A	4
G32	Advanced Battleground	No	1-2	N/A	N/A
G33	Paintball	No	1-2	N/A	3
G34	Cat & Mouse	No	1-2	N/A	N/A

**READ FIRST - OPERATION**

1. Press the POWER to activate dartboard. A short musical introduction is played as the display goes through a power-up test.
2. Press GAME button until the desired game is displayed.
3. Press DOUBLE button (optional) to select Double In/Out or Master Out.

Single In/Single Out	The game is started and ended by hitting any segment
Double In/Single Out	A double must be hit to start scoring. Any segment may be hit to end the game.
Single In/ Double Out	Any segment may be hit to start the game. A double must be hit to end the game
Double In/Double Out	A double must be hit to start scoring and to end the game.
Single In/Master Out	Any segment may be hit to start the game. A double or triple is required to finish the game.
Double In/Master Out	A double must be hit to start scoring. A double or triple is required to finish the game.

4. Press PLAYER/PAGE button to select the number of players (1, 2 ... 8). This button will also allow selection of teams (if available). After eight players is displayed, press the PLAYER/PAGE button again to display 2-2. The dartboard will announce "Two Teams". This option will play with two teams having two players on each team. See the table for the available team options. The default setting is 2 players. Or select I MATCH option by pressing the I MATCH button.

2 Teams	2 Players On Each Team
3 Teams	2 Players On Each Team
4 Teams	2 Players On Each Team

5. Press START/NEXT PLAYER button (red) to activate game and begin play.
6. Throw darts: When all 3 darts have been thrown, a voice command will indicate "Remove Darts" and the score will flash. The darts can now be removed without affecting the electronic scoring. When all darts are removed from the playing surface press the START/NEXT PLAYER button to go to next player. Voice command will indicate which player is up. Also, the player indicator lights will illuminate to show which player's turn it is.

## DARTBOARD FUNCTIONS

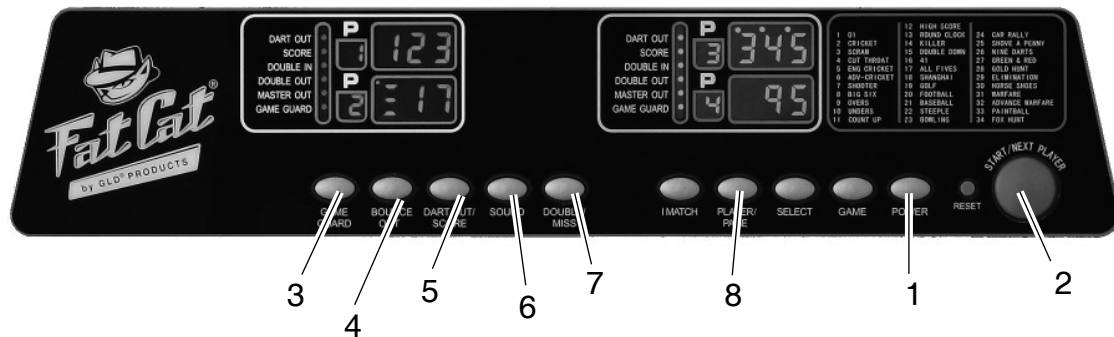

1. **POWER** switch/button - Located on the lower right corner on the side of the dartboard. Be sure the AC Adapter is plugged into the jack on the bottom of the dartboard or batteries are installed. Press the **POWER** switch to turn game on or off.
2. **START/NEXT PLAYER** button - This multi-function button is used to:
  - **START** the game when all options have been selected.
  - Put dartboard in Hold status between rounds to allow player to remove darts from the target area.
  - Enable the next player.
3. **GAME GUARD** button - After the **START** button has been pressed and play has begun, the Game Guard feature can be activated. When the button is pressed, all of the keys will 'lock'. When Game Guard is active, a misguided dart hitting a button will not affect your game. To deactivate the Game Guard, simply press the button again and the keys will unlock.
4. **BOUNCE OUT** button - Decide before play if you want to count darts that do not remain in board ("bounce-outs") or not. If not, simply press the **BOUNCE OUT** button immediately after a bounce out occurs to deduct the score that registers.
5. **DART-OUT/SCORE** button - The Dart-Out feature is active only during the "01" games (301, 401, etc.). When a player's score falls below 160, he/she can press the **DART OUT** button to get a suggestion from the dartboard as to the 3 darts needed to finish the game. Note: doubles and triples are indicated with 2 and 3 dashes to the left of the number respectively. The **SCORE** feature allows player to access scores not currently on display.
6. **SOUND** button - Sound level adjustable from 0-7 levels (8 levels).
7. **DOUBLE/MISS** button - This button is used to activate the Double In/Double Out and Master Out options. The Miss feature is active during play of any game. Press button to register a "missed" dart. The player can press this button when a dart lands outside target area so computer registers a thrown dart.
8. **PLAYER/PAGE** button – This button is used at the start of each game to select the number of players you want to play the game. In addition, this button allows players to see other player scores not on the active display.

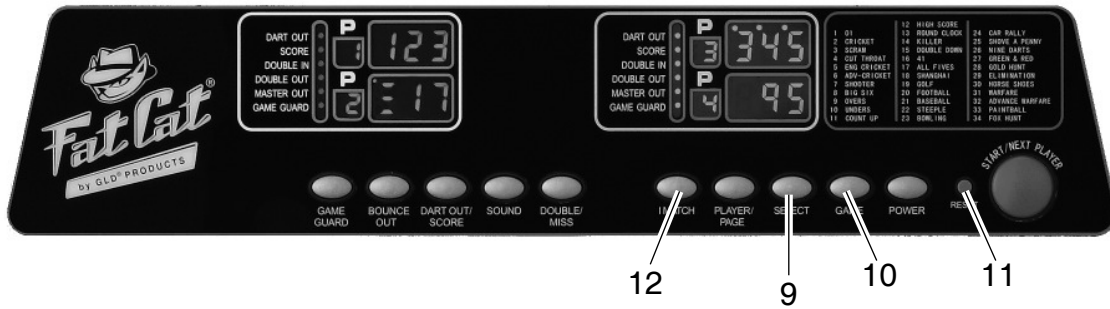

- 9. **SELECT** button – Press to select various options for games. Not all games have options. The option selected is displayed on the right side Player Score Display.
- 10. **GAME** button – Press to page through the on-screen game menu and select game. The game selected is displayed on the left side Player Score Display.
- 11. **RESET** button – Press to clear display and reset dartboard to opening sound and display.
- 12. **I MATCH** button – This exciting feature allows a single player to play against the computer at one of five different levels of skill! Only 1 player can compete against the I MATCH competitor at a time. This feature adds a level of competition to normally routine practice sessions.

<b>I MATCH Skill Levels</b>	
Level 1 (C1)	Professional
Level 2 (C2)	Advanced
Level 3 (C3)	Intermediate
Level 4 (C4)	Novice
Level 5 (C5)	Beginners

Press to activate I MATCH feature to play against the computer and then press START. When play begins: the ‘human’ player throws first. After 3 darts are thrown, go to the board to take darts out and press START to change to the next player (Computer Opponent). Watch as the Computer opponent’s dart scores are registered on the display. The dartboard will indicate the segment the I MATCH opponent is throwing for the in Active Score Display (the ATTEMPT LED will light). Then the Active Score Display will indicate the segment that the Computer opponent actually scored (the RESULT LED will light). After the I MATCH opponent completes his round, the board will automatically reset for the ‘human’ player. Play continues until one player wins.

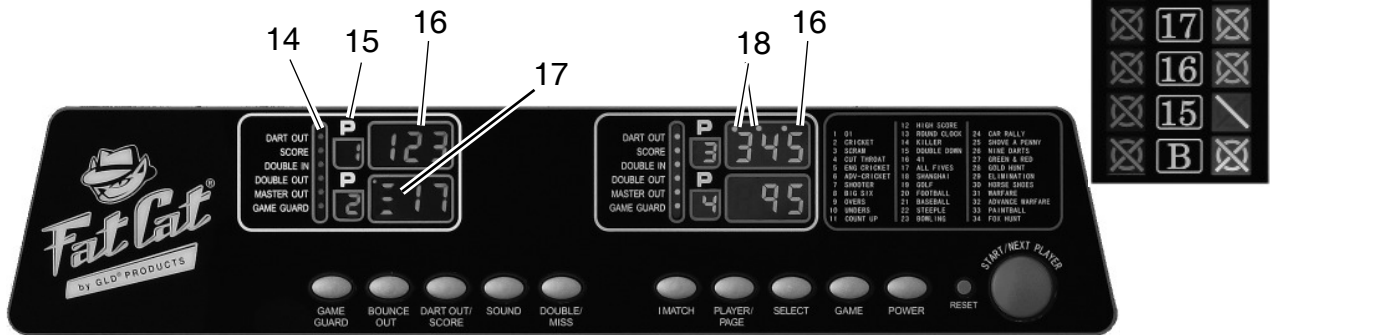

- 13. Cricket Scoring Display: This dartboard utilizes a dedicated scoreboard, located on the inside of the cabinet doors, that keeps track of each player’s segment status when playing Cricket. The exclusive Tournament Cricket Scoring display on this dartboard utilizes traditional X and O style characters to track ‘marks’. When Cricket is selected, the lights on the Cricket scoreboard are not lit – they will illuminate as ‘marks’ are scored. There are 3 separate lights within each number (15 through 20 and bullseye). During play, one of the status lights will turn on as a segment is hit. If a double or triple of an active number is hit, 2 or 3 lights will turn on respectively.
- 14. Options Display: Lights (and announcer) will display which options have been selected. Active for G01 games and select others. Also shows when game guard is active.
- 15. Player Number Display: The number indicates the player that the cricket and score displays apply to.
- 16. Player Score Display: Displays scoring information for the player that is shown in the Player Number Display.
- 17. Segment Identifier: The number of lines indicates the segment of interest.

Triple	Double	Single
≡	==	—

- 18. Number of Darts Remaining: Each dot showing, represents a dart that is yet to be thrown in this round.

**MERCURY GAME DESCRIPTIONS & RULES****G01 301 (with scoring options of 501, 601, 701, 801, 901)****Game Options:**

Single In/Single Out  
 Double In/Single Out  
 Double In/Double Out  
 Single In/Double Out  
 Single In/Master Out  
 Double In/Master Out

The scoring options are the starting score, see the chart below.

<b>Scoring Option</b>	301	501	601	701	801	901
<b>Starting Score</b>	301	501	601	701	801	901

Refer to the section “Read First - Operation”.

**Playing the Game**

To win: A player will win when their score reaches exactly 0 (zero).

- This popular tournament and pub game is played by subtracting each dart from the starting total until the player reaches exactly 0 (zero).
- If a player goes past zero it is considered a “Bust” and the score returns to where it was at the start of that round. For example, if a player needs a 32 to finish the game and he/she hits a 20, 8, and 10 (totals 38), the score goes back to 32 for the next round.
- Dart-Out Feature (“01” games only). When a player requires less than 160 to reach zero, the estimate feature becomes active. The player can press the DART OUT button to view the segments necessary to finish the game (reach zero exactly). Doubles and triples are indicated with 2 or 3 lines to the left of each number respectively.
- For **Single In** or **Single Out** options, the game can be started or ended by throwing at any segment, regardless if single, double or triple.
- If you selected **Double In**, you must hit a double segment to start the game. If you selected **Double Out** you must hit a double segment to end the game.
- For **Master Out**, the game is ended by hitting a double or triple.



**G02 Cricket (with scoring options of Std and nc)**

Refer to the section “Read First - Operation”.





The scoring options are described in the chart below.

Scoring Options	Description
Std	Standard Cricket - Hit and open numbers 15-20 and bullseye in any order and have an equal or greater score than the other players before all the numbers are closed.
nc	No-Score Cricket - No points are scored, the first player to close numbers 15-20 and bullseye wins.

**Playing the Game**

To win: A player wins the game when he first opens all the numbers and has an equal or greater score than the other players. However, if players are tied on points, or have no points, the first player to open all numbers wins.

**Note:** A single segment counts as one hit, a double segment counts as two hits and a triple segment counts as three hits.

Cricket Status	One Time	Two Times	Open	Close
Sign				

- In Cricket only the numbers 15-20 and bullseye are used.
- All valid hits will be confirmed and displayed by the Cricket Display.
- When a number has been hit 3 times by a player, it is then open to that player and any further hits by that player will score points. (Not active for No-Score Cricket.)
- Once a number has been hit 3 times by all the players, that number is then closed and can no longer be scored upon by any player. At that time the indicator will change to closed for that number.
- A player who has opened a number can continue to score on that number until it becomes closed. (Not active for No-Score Cricket.)
- If a player has opened all numbers first, but is behind on points, scoring continues on open numbers. If that player has not accumulated the highest point total by the time another player opens all their numbers, the player with the most points will be the winner. (Not active for No-Score Cricket.)
- Numbers can be opened or closed in any order.





## G03 Scram Cricket

Refer to the section “Read First - Operation”.

### Playing the Game

To win: During round 2, if Player 1’s score goes over Player 2’s score the game will end and Player 1 will be the winner. If Player 2 closes all the numbers and has a higher score than Player 1, Player 2 will be the winner.

**Note:** A single segment counts as one hit, a double segment counts as two hits and a triple segment counts as three hits.

Cricket Status	One Time	Two Times	Open	Close
Sign				

- All valid hits will be confirmed and displayed by the Cricket Display.
- The game consists of 2 rounds. In the first round, player 1 must close 15 through 20 and bullseye while player 2 attempts to get as high a score as he can by scoring on the open numbers. Round 1 will be finished when all numbers have been closed. For round 2, the reverse is done. Player 2 attempts to close 15 through 20 and the bullseye. Player 1 attempts to get a high score.
- During round 2, if Player 1’s score goes over Player 2’s score the game will end and Player 1 will be the winner. If Player 2 closes all the numbers and has a higher score than Player 1, Player 2 will be the winner.





**G04 Cut Throat Cricket**

Refer to the section “Read First - Operation”.

**Playing the Game**

To win: The player who first closes all numbers and has the lower score wins.

**Note:** A single segment counts as one hit, a double segment counts as two hits and a triple segment counts as three hits.

Cricket Status	One Time	Two Times	Open	Close
Sign				

- In Cut Throat Cricket only the numbers 15-20 and bullseye are used.
- If every player has opened a number, that number will then close.
- All valid hits will be confirmed and displayed by the Cricket Display.
- Once the scoring begins, points are added to your opponents scores who haven't opened that number.
- If a player closes all numbers first but is ahead in points, they must continue to score on the open numbers.
- If a player does not reach the lowest score before the opposing player(s) closes all the numbers, the other player wins. Play continues until all segments are closed.

**G05 English Cricket**

Refer to the section “Read First - Operation”.

**Playing the Game**

To win: The player with the most points is the winner.

- This game is for 2 players only.
- This game is another variation of Cricket that requires precision dart throwing.
- The game consists of two rounds. The players have a different objective in each round.
- During the first round, player 2 attempts to throw bullseyes – with the objective of needing 9 bullseyes to complete round 1.
- Double bull (red center) counts as 2 scores.
- Any throw that does not hit bullseye is credited to player 1's point total. For example, if player 2 throws a 20, a single bullseye, and a 7 during his/her turn, player 2 will have one bullseye subtracted from the 9 needed, and 27 points will be credited to player 1's point total.
- Meanwhile, player 1 attempts to score as many points as possible during this first round.
- Doubles and triples count 2x and 3x their respective values.
- To score points, player 1 must score over 40 points in each turn (3 throws) to add points.
- Only those points over 40 are counted toward the cumulative score.
- Player 1 must also avoid hitting any bullseyes during this first round because any hits scored by player 1 in the bullseye area will be subtracted from player 2's needed total of 9 bullseyes. Once player 2 reaches the objective of getting 9 bullseyes, the roles are reversed for round two.





**G06 Advanced Cricket**

Refer to the section “Read First - Operation”.

**Playing the Game**

To win: The first player to close out the numbers with the most points is the winner.

**Note:** A single segment counts as one hit, a double segment counts as 1x the number, and triple segments count as 2x the number.

Cricket Status	One Time	Two Times	Open	Close
Sign				

- Players must close out the segments (20, 19, 18, 17, 16, 15 and bullseye) by using only triples and doubles.
- The bullseye scoring is the same as in standard cricket.

**G07 Shooter (with scoring options of 6, 7, 8, 9, 10, 11, 12)**

The scoring options are the number of rounds played, see the chart below.

<b>Scoring Option</b>	6	7	8	9	10	11	12
<b>Number of Rounds</b>	6	7	8	9	10	11	12

Refer to the section “Read First - Operation”.

**Playing the Game**

To win: The player with the most points at the end of the rounds is the winner.

- The computer will randomly select the segment the players must shoot for at the start of each round, indicated by a flashing number in the display.
- Scoring is as follows: single segment = 1 point, double segment = 2 points, triple segment = 3 points.
- When the computer selects players to hit double bullseye, the outer bull scores 2 points and the inner bull scores 4 points.

**G08 Big Six (with scoring options of 3, 4, 5, 6, 7)**

The scoring options are the number of lives, see the chart below.

<b>Scoring Option</b>	3	4	5	6	7
<b>Number of Lives</b>	3	4	5	6	7

Refer to the section “Read First - Operation”.

**Playing the Game**

To win: If a player loses all their lives they are out of the game. The remaining players continue the game until one player is left with lives. That player is the winner.

- This game allows players to challenge their opponents to hit the targets of their choice. Players must earn the chance of picking the next target for their opponent by making a hit on the current target first.
- Before the game starts, players must agree on how many lives will be used by pressing SELECT button. Single 6 is the first target to hit when the game begins.
- Within the three throws, player 1 must hit a 6 to “save” their life.
- After the current target is hit, the next dart thrown will determine the opponent’s target.
- If player 1 fails to hit the current target within 3 darts, they will lose a life and a chance to determine the next target for player 2.
- Player 2 will shoot for the single 6 that player 1 missed – and if it is hit, he can throw for a segment for the next round.
- Singles, doubles and triples are all separate targets for this game.
- The object of the game is to force your opponent into losing lives by selecting tough targets for your opponent to hit such as “double bullseye” or “triple 20”.

**G09 Overs (with scoring options of 3, 4, 5, 6, 7)**

The scoring options are the number of lives, see the chart below.

<b>Scoring Option</b>	3	4	5	6	7
<b>Number of Lives</b>	3	4	5	6	7

Refer to the section “Read First - Operation”.

**Playing the Game**

To win: The last player with a life remaining is the winner.

- The object of this game is to simply score higher (over) than your own previous three dart total score.
- Before play begins, players choose the amount of lives to be used by pressing the SELECT button.
- When a player fails to score over their previous three-dart total, they will lose one life.
- When a player equals the previous three dart total, a life will also be lost.
- The Cricket Display will light up once for each life taken away.

**G10 Unders (with scoring options of 3, 4, 5, 6, 7)**

The scoring options are the number of lives, see the chart below.

<b>Scoring Option</b>	3	4	5	6	7
<b>Number of Lives</b>	3	4	5	6	7

Refer to the section “Read First - Operation”.

**Playing the Game**

To win: The last player with a life remaining is the winner.

- This game is the opposite of “Overs”. Players must score less (under) than their own previous three-dart total.
- The game begins with 180 (highest total possible). When the player shoots higher than his or her own previous three-dart total, they will lose a life.
- Each dart that hits outside the scoring area, including bounce outs will be penalized with 60 points added to your score. This will be added at the end of the round when the START/HOLD button is pressed.

## G11 Count-Up (with scoring options of 300, 400, 500, 600, 700, 800, 900, 999)

### Game Options:

- Single In/Single Out
- Double In/Single Out
- Double In/Double Out
- Single In/Double Out
- Single In/Master Out
- Double In/Master Out

The scoring options are the point total (ending score), see the chart below.

Scoring Option	300	400	500	600	700	800	900	999
Point Total (Ending Score)	300	400	500	600	700	800	900	999

Refer to the section “Read First - Operation”.

### Playing the Game

To win: The first player to reach the specified point total (300, 400...900, 999) is the winner.

- Point total (ending score) is specified when the game is selected.
- Each player attempts to score as many points as possible per round.
- Doubles and triples count 2 or 3 times the numerical value of each segment. For example a dart that lands in the triple 20 segment is scored as 60 points.
- The cumulative scores for each player will be displayed in the LED display as the game progresses.
- For **Single In** or **Single Out** options, the game can be started or ended by throwing at any segment, regardless if single, double or triple.
- If you selected **Double In**, you must hit a double segment to start the game. If you selected **Double Out** you must hit a double segment to end the game.
- For **Master Out**, the game is ended by hitting a double or triple.

**G12 High Score (with scoring options of 03r, 04r, 05r, 06r, 07r, 08r, 09r, 10r, 11r, 12r, 13r, 14r)**

**Game Options:**

- Single In/Single Out
- Double In/Single Out
- Double In/Double Out
- Single In/Double Out
- Single In/Master Out
- Double In/Master Out

The scoring options are the number of rounds, see the chart below.

<b>Scoring Option</b>	03r	04r	05r	06r	07r	08r	09r	10r	11r	12r	13r	14r
<b>Number of Rounds</b>	3	4	5	6	7	8	9	10	11	12	13	14

Refer to the section “Read First - Operation”.

**Playing the Game**

To win: Score the most points in the selected number of rounds.

- Doubles and triples count as 2x and 3x that segment’s score respectively.

**G13 Round-The-Clock (with scoring options of r01, r05, r10, r15, d01, d05, d10, d15, t01, t05, t10, t15)**

The scoring options are the first number that will be thrown and the segment that must be hit, see the chart below.

<b>Scoring Option</b>	r01	r05	r10	r15				
<b>First Number Thrown</b>	1	5	10	15				
	Single, Double or Triple Segments							
<b>Scoring Option</b>	d01	d05	d10	d15	t01	t05	t10	t15
<b>First Number Thrown</b>	D1	D5	D10	D15	T1	T5	T10	T15
	Must hit only Double segments				Must hit only Triple segments			

Refer to the section “Read First - Operation”.

**Playing the Game**

To win: The first player to reach and score on the 20 segment is the winner.

- Each player attempts to hit in each number from 1 through 20 and bullseye in order.
- Each player throws 3 darts per turn. If a correct number is hit, he/she tries for the next number in sequence.
- The display will indicate which segment you are shooting for.
- A player must continue shooting for a segment until it is hit.
- The display will then indicate the next segment you should shoot for.



**G14 Killer (with scoring options of 3, 5, 7, 07, 08, 09, 10, 11, 12, 13, 14)**

The scoring options are the number of lives you have and what segments to hit for a kill, see the chart below.

<b>Scoring Option</b>	3	5	7	07	08	09	10	11	12	13	14
<b>No. of Lives</b>	3	5	7	7	8	9	10	11	12	13	14
	Must hit Doubles only to "kill" (take a life). Single or Triple count as a miss.			A Single segment will count as 1 "kill" (1 life). A Double will count as 2 "kills" (2 lives). A Triple will count as 3 "kills" (3 lives).							

Refer to the section “Read First - Operation”.

**Playing the Game**

To win: The last player with “Lives” will be the winner.

- To start, each player must select his number by throwing a dart at the target area. The display will indicate “SEL” at this point.
- The number each player gets is his assigned number throughout the game.
- No two players can have the same number.
- Once each player has a number, the action starts.
- Your first objective is to establish yourself as a “Killer” by hitting the double segment of your number. Once your double is hit, you are a “Killer” for the rest of the game.
- Now, your objective is to “kill” your opponents by hitting their segment number until all their “lives” are lost.
- If you hit your own segment you will lose a life.

**G15 Double Down**

Refer to the section “Read First - Operation”.

**Playing the Game**

To win: The player with the highest score after the last round is the winner.

- Each player starts the game with 40 points. The object is to score hits in the active segment of the current round.
- In the first round, the player must throw three darts for the 15 segment. If no 15’s are hit, his score is cut in half. If some 15’s are hit, each 15 (doubles and triples count) is added to the starting total.
- The next round players throw for the 16 segment and hits are added to the new cumulative point total. Again, if no hits are registered, the point total is cut in half.
- Each player throws for the numbers as indicated in the chart below in order (the screen will indicate the active segment at which to throw).
- The designated numbers for each round are:

<b>Round</b>	1	2	3	4	5	6	7	8	9
<b>Target Number</b>	15	16	Any Double	17	18	Any Triple	19	20	25 Bullseye

**G16 Forty One**

Refer to the section “Read First - Operation”.

**Playing the Game**

To win: The player with the highest score after the last round is the winner.

- This game follows similar rules as G15 Double Down as described with two exceptions.
- First, instead of going from 15 through 20 and bullseye, the sequence is reversed which will be indicated on the display.
- Second, an additional round is included toward the end in which players must attempt to score three hits that add up to 41 points.
- This “41” round adds an extra level of difficulty to the game. Remember, a player’s score is cut in half if not successful, so the “41” round presents quite a challenge.
- The designated numbers for each round are:

<b>Round</b>	1	2	3	4	5	6	7	8	9	10
<b>Target Number</b>	20	19	Any Double	18	17	Any Triple	16	15	“41” Points	25 Bullseye

**G17 All Fives (with scoring options of 51, 61, 71, 81, 91)**

The scoring options are the number of fives you need, see the chart below.

<b>Scoring Option</b>	51	61	71	81	91
<b>Number of Fives</b>	51	61	71	81	91

Refer to the section “Read First - Operation”.

**Playing the Game**

To win: The first player to get the selected number of “fives” is the winner.

- The entire board is in-play for this game (all segments are active).
- With each round (of 3 darts) each player has to score a total which is divisible by 5. Every “five” counts as one point. For example 10, 10, 5 = 25. Since 25 is divisible by 5 fives, this player scores 5 points ( $5 \times 5 = 25$ ).
- If a player throws 3 darts and the total is not divisible by 5, no points are given.
- The last dart of each round must land in a segment. If a player throws the third dart and it lands in the catch ring area (or misses the board completely), he earns no points even if the first two darts are divisible by 5. This prevents a player from “tanking” the third throw if his first two are good.
- The screen will keep track of the point totals.
- The Cricket Display keeps track of the darts thrown.

**G18 Shanghai (with scoring options of 01, 05, 10, 15, S01, S05, S10, S15)**

The scoring options are the starting number, see the chart below.

<b>Scoring Option</b>	01	05	10	15	S01	S05	S10	S15
<b>Starting Number</b>	1	5	10	15	1	5	10	15
	These games go from the starting number through 20.				These games are only 7 rounds.			

Refer to the section “Read First - Operation”.

**Playing the Game**

To win: The player with the highest score after completing all the targets is the winner.

- Players throw 3 darts each turn.
- The dartboard will display the current target on the Player Score Display.
- The Cricket Display will keep track of the number of darts thrown.
- Doubles count as double points and triples count as triple the points.
- For both games any segment of the target number will score points.

**G19 Golf (with scoring options of 09H, 10H, 11H, 12H, 13H, 14H, 15H, 16H, 17H)**

The scoring options are the number of holes, see the chart below.

<b>Scoring Option</b>	09H	10H	11H	12H	13H	14H	15H	16H	17H	18H
<b>Number of Holes</b>	9	10	11	12	13	14	15	16	17	18

Refer to the section “Read First - Operation”.

**Playing the Game**

To win: The person to complete all their “holes” with the lowest number of “strokes” (darts) wins and the game is over.

- This is a dartboard simulation of the game golf. The Championship “course” consists of all par 3 holes making par 27 for a 9 hole round or par 54 for a round of 18 holes.
- Numbers 1-18 are the “holes” of the golf course and must be hit in order.
- Players take turns throwing 3 darts until one player scores on the "hole" 3 times. Then the opponent will continue to throw at the "hole" until he has 3 scores on it.
- Every three darts the NEXT PLAYER button will need to be pressed.
- You must score 3 hits in each hole to move to the next hole. A Double will count as two hits, a Triple will count as three hits. Doubles and Triples allow you to finish a hole with fewer strokes. For example, throwing a Triple on the first shot of a hole will count as an “eagle” and that player completes that hole with 1 “stroke.”
- The dartboard will display the number you are on.
- Each dart thrown counts as a “stroke”, whether it hits your designated number or not, and will be displayed on the scoreboard for each player.
- The Cricket Display will show how many “holes” are finished.

**Note:** The voice announcer will indicate the player that is up - listen carefully to avoid shooting out of sequence.

## G20 Football

Refer to the section "Read First - Operation".

### Playing the Game

To win: The first player who finishes crossing their playing field is the winner.

- To start the game each player must select their "playing field. This is done (when the player display shows SEL) by throwing a dart or by manually pressing a segment on the board by each player.
- Once a "playing field" is selected, the players must hit the segments in order from the outside double segment of your number working your way in to the bullseye and to the opposite side to the outer double segment. See illustration and example below.
- The display will keep track of your progress and indicate the segment you need to throw for next.
- A dart that hits a segment out of their playing field or out of order is a miss.

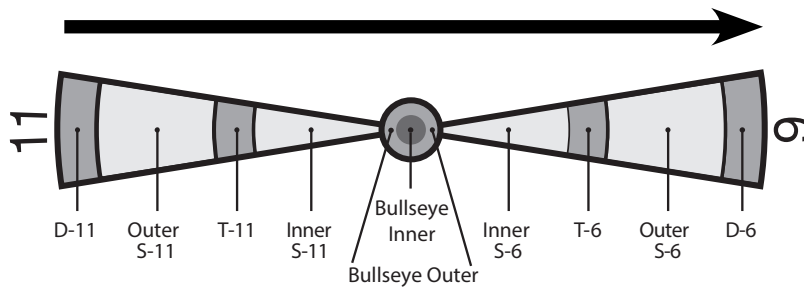

- For example, if a player selects segment 11, they have to hit D-11, outer S-11, T-11, inner S-11, outer bullseye, inner bullseye, outer bullseye, inner S-6, T-6, outer S-6 and finally D-6.

**G21 Baseball (with scoring options of 6, 7, 8, 9)**

The scoring options are the number of innings you will play, see the chart below.

<b>Scoring Option</b>	6	7	8	9
<b>Number of Innings</b>	6	7	8	9

Refer to the section “Read First - Operation”.

**Playing the Game**

To win: The player with the most runs at the end of the last inning is the winner.

- The game consists of 6-9 innings.
- Runs are scored by hitting the active segment number to advance a runner around the bases. The dartboard will display the active segment number.

<b>Segment</b>	<b>Result</b>
Single	“Single” - one base
Double	“Double” - two bases
Triple	“Triple” - Three bases
Bullseye	“Home Run” (can only be attempted on last dart of the inning)

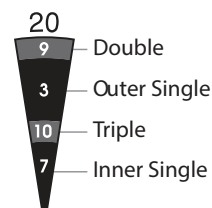

- The inning is shown at the Player Score Display. This is also the active segment number.
- The active segment number is the only number that will advance the runners when hit. EXCEPTION - The last dart in the inning will score a home run if a bullseye is hit.
- The top half of the Cricket Display will show the runners on base. The bottom half of the Cricket Display will indicate the runs scored in the innings. This resets every 3 innings.

**G22 Steeplechase**

Refer to the section “Read First - Operation”.

**Playing the Game**

To win: The first player to complete the course and hit the bullseye wins the race.

- The object of this game is to be the first player to finish the “race” by being the first to complete the “track.” The track starts at the 20 segment and runs clockwise around the board to the 5 segment and ends with a bullseye.
- You must hit the inner single segment of each number to get through the course. This is the area between the bullseye and the triples ring.
- As with a real steeplechase, there are obstacles throughout the course to hurdle. The four hurdles are found at the following places:

<b>Hurdle</b>	<b>Location</b>
1st fence	Triple 13
2nd fence	Triple 17
3rd fence	Triple 8
4th fence	Triple 5

**G23 Bowling (with scoring options of 10, 11, 12, 13, 14, 15)**

The scoring options are the number of frames, see the chart below.

<b>Scoring Option</b>	10	11	12	13	14	15
<b>Number of Frames</b>	10	11	12	13	14	15

Refer to the section “Read First - Operation”.

**Playing the Game**

To win: The player with the highest points or “pins” at the end of the game is the winner.

- For each turn the dartboard will display SEL. For each turn your first dart will select the “Alley” and the second and third dart will score “pins” or points, provided they hit segments in the “Alley”. Hitting the bullseye will not count as an “Alley” or give you any “pins” or points. “Pins” or points are scored as follows:

<b>Segment</b>	<b>Result</b>
Double	9 pins
Outer Single	3 pins
Triple	10 pins
Inner Single	7 pins

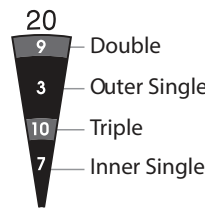

- You cannot hit the same singles segment twice within the same “frame” (round). The second hit will count as zero points. Hint: Try to hit each single to reach 10 points in the frame.
- You can hit the same triple or double segment twice. However hitting the double segment twice in a row will give you 10 “pins” or points. Hitting the triple segment twice will give you 20 “pins” or points.
- If the second dart hits the double segment and the third dart hits any segment, you score 10 pins.
- If the second dart hits a single segment and the third dart hits the double segment, you score 9 pins.
- If the second dart hits the triple segment and the third dart hits the double segment, you score 19 pins.

## G24 Car Rallying

Refer to the section “Read First - Operation”.

### Playing the Game

To win: The first player to complete the course is the winner.

- This game is similar to Steeplechase except you set up your own “race track.” You can set up as many obstacles as you wish. The track must be 19 laps (segments) long.
- Before the game starts, the display will prompt you to select the course (“SEL”).
- Players should alternate selecting segments by pressing on the specific segment of your choice. The route can be made as difficult or easy as you wish and can go anywhere on the target area of the board.

**Note:** You will have to hit the exact segment you selected to move on during the race. If you choose inner single 20, that inner single area will need to be hit during the race.

- The display will indicate inner single with a line next to the bottom of the 1, an outer single is shown with a line next to the top portion of the 1.
- Obstacles are usually hitting a difficult number before continuing on the racetrack.
- After the track is selected, press START to begin the race.

## G25 Shove A Penny

Refer to the section “Read First - Operation”.

### Playing the Game

To win: The first player to score 3 points in all segments (15 - 20 and bull) is the winner.

- Only the numbers 15 through 20 and the bullseye are used. Singles are worth 1 point, doubles are worth 2 points, and triples are worth 3 points.
- Each player must throw for the numbers in order with the objective of scoring 3 points in each segment to move on to the next.
- If a player scores more than 3 points in any one number, the excess points are given to the next player.

## G26 Nine-Dart Century

### Game Options:

Single In/Single Out  
Double In/Single Out  
Double In/Double Out  
Single In/Double Out  
Single In/Master Out  
Double In/Master Out

Refer to the section “Read First - Operation”.

### Playing the Game

To win: The player who scores 100 points or comes as close as possible after 3 rounds (9 darts) is the winner.

- Doubles and triples count as 2x and 3x their value respectively.
- Going over 100 points is considered a “bust” and causes you to lose. If all players go over, the player closest to 100 wins (player that scored the lowest amount over 100).



**G27 Green Vs. Red**

Refer to the section “Read First - Operation”.

**Playing the Game**

To win: The player with the most points after completion of the game is the winner.

- This game is a race around the board.
- Player 1 is “green” and player 2 is “red.” The Player Score Display will indicate which segment to throw for.
- Player 1 starts at segment 1. Scoring is on the double and triple segments of the displayed number and works around the board clockwise.
- Player 2 starts at 20 and works around the board counter-clockwise.

**Note:** A maximum of one double and one triple of the same number can be scored in a single round.

- Hitting a segment of your opponents color subtracts that amount from your score.
- Your segments may not be green and red. In that case, player 1 starts at segment 1 and player 2 starts at segment 20.

**G28 Gold Hunting (with scoring options of 10, 11, 12, 13, 14, 15, 16, 17, 18, 19, 20, 21)**

The scoring options are the total amount of gold, see the chart below.

<b>Scoring Option</b>	10	11	12	13	14	15	16	17	18	19	20	21
<b>Total Amount of Gold</b>	10	11	12	13	14	15	16	17	18	19	20	21

Refer to the section “Read First - Operation”.

**Playing the Game**

To win: The first player to reach the selected total amount of gold wins.

- The object of this game is to find “gold.”
- A player collects one gold if their score is a multiple of 50 at any point during the round.

**G29 Elimination (with scoring options of 3, 4, 5)**

The scoring options are the number of lives, see the chart below.

<b>Scoring Option</b>	3	4	5
<b>End Point Total</b>	3	4	5

Refer to the section “Read First - Operation”.

**Playing the Game**

To win: The winner is the last player with lives remaining.

- The object of the game is to “Eliminate” your opponents.
- Each player must score higher total points with 3 darts than the opponent before them.
- Each player starts with 3, 4 or 5 lives.
- If the player fails to score higher total points than the previous opponents score, they lose one life.
- Tie scores will also result in a lost life.
- The Cricket Display will keep track of the lives lost.

**G30 Horseshoes (with scoring options of 15, 16, 17, 18, 19, 20, 21, 22, 23, 24, 25)**

The scoring options are the end point total, see the chart below.

<b>Scoring Option</b>	15	16	17	18	19	20	21	22	23	24	25
<b>End Point Total</b>	15	16	17	18	19	20	21	22	23	24	25

Refer to the section “Read First - Operation”.

**Playing the Game**

To win: First player to score 15 points is the winner.

- This 2 -player game uses only the 20 and the 3 segments to represent the two horseshoe pits.
- Player 1 will shoot at the 20 segment and Player 2 will shoot at the 3 segment.
- Scoring is cumulated per round. Scoring is as follows:

<b>Segment</b>	<b>Points</b>
Triple Ring	Ringer 3 points
Inner Single	1 point
Double Ring	Leaner 2 points
Outer Single	0 point

- Scores will only count for the player or team with the most points in that round. For example, if player 1 scores 3 points and player 2 scores 1 point, player 1 will be awarded 3 points for that round.
- Rounds continue until 15 points are scored.
- The Cricket Display will keep track of how many horseshoes are thrown.

**G31 Battleground (with scoring options of Sin, dou, tri, Gen)**

The scoring options are described in the chart below.

Scoring Options	Description
Sin	Players shoot for any segment to eliminate opponent's armies.
dou	Players shoot for double segments only to eliminate opponent's armies.
tri	Players shoot for triple segments only to eliminate opponent's armies.
Gen	This variation of the game includes one more obstacle to accomplish. Players must capture the "general" after all segments (armies) have been hit to win the game. One hit on the bullseye will capture the general. Hits to the bullseye will not count if all segments are not first closed.

Refer to the section "Read First - Operation".

**Playing the Game**

To win: The first player to hit all of the opposing segments (armies) wins the game.

- In this 2-player game, the dartboard is a battleground divided into two halves.
- Segments do not have to be hit in order.
- Player 1 is the "TOP" army and shoots darts at the bottom sections of the board.
- Player 1 needs to hit bottom segments (6, 10, 15, 2, 17, 3, 19, 7, 16, and 8)
- Player 2 is the "BOTTOM" army and shoots for the top section of the dartboard
- Player 2 needs to hit top segments (11, 14, 9, 12, 5, 20, 1, 18, 4, and 13)
- The left Cricket Display on the dartboard shows player 1's armies (player 2 targets). Player 2's armies (player 1 targets) are in the right side of the Cricket Display. Each time a segment is hit, the corresponding light will shut off.
- The illustration shows what targets each player must hit.

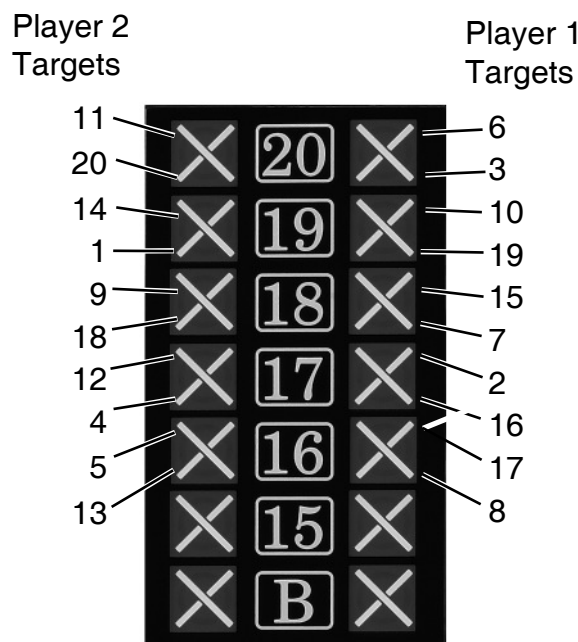

## G32 Advanced Battleground

Refer to the section "Read First - Operation".

### Playing the Game

To win: The first player to hit all of the opposing segments (armies) wins the game.

- The rules are the same as standard Battleground except now there are land mines on the battlefield.
- Players must be careful to avoid the land mines located in the Triple and Double rings of opponents segment numbers.
- Any player that hits a double or triple ring on the opposing teams' battlefield will lose an army of his or her own. For example, if player 1 mistakenly hit the triple ring of the "6" segment, they would lose their own army at the "11" segment.
- Segments do not have to be hit in order.
- Player 1 is the "TOP" army and shoots darts at the bottom sections of the board.
- Player 1 needs to hit bottom segments (6, 10, 15, 2, 17, 3, 19, 7, 16, and 8)
- Player 2 is the "BOTTOM" army and shoots for the top section of the dartboard
- Player 2 needs to hit top segments (11, 14, 9, 12, 5, 20, 1, 18, 4, and 13)
- The left Cricket Display on the dartboard shows player 1's armies (player 2 targets). Player 2's armies (player 1 targets) are in the right side of the Cricket Display. Each time a segment is hit, the corresponding light will shut off.
- The illustration shows what targets each player must hit.

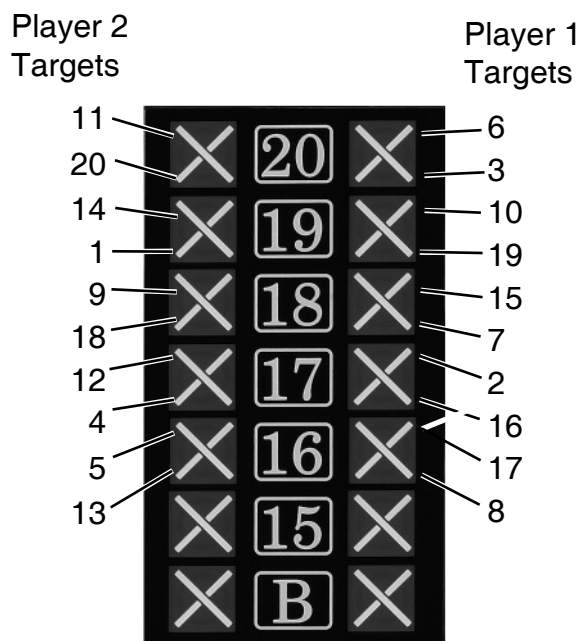

**G33 Paintball (with scoring options of Sin, dou, tri)**

The scoring options are described in the chart below.

<b>Scoring Options</b>	<b>Description</b>
Sin	Players must either hit 3 double bullseyes to capture the flag or hit any segment to eliminate armies.
dou	Players must either hit 3 double bullseyes to capture the flag or hit double ringed segments to eliminate armies.
tri	Players must either hit 3 double bullseyes to capture the flag or hit triple ringed segments to eliminate armies.

Refer to the section “Read First - Operation”.

**Playing the Game**

To win: First player to either capture the flag or eliminate the opposing army is the winner.

- This game is similar to “Battleground” except there is an alternative way to win the battle other than just hitting the opposing teams’ armies segments.
- As in the real game of paintball, players can also capture the opposing team’s flag to win the game.
- To capture the flag, the double bullseye must be hit 3 times to capture the opposing teams’ flag.
- Single bullseyes will not count towards the 3 needed to capture the flag.
- Double bullseyes do not have to be scored in the same round and will be tallied during the game.
- Player 1 is the “TOP” army and shoots darts at the bottom sections of the board.
- Player 1 needs to hit bottom segments (6, 10, 15, 2, 17, 3, 19, 7, 16, and 8)
- Player 2 is the “BOTTOM” army and shoots for the top section of the dartboard
- Player 2 needs to hit top segments (11, 14, 9, 12, 5, 20, 1, 18, 4, and 13)
- The left Cricket Display on the dartboard shows player 1’s armies (player 2 targets). Player 2’s armies (player 1 targets) are in the right side of the Cricket Display. Each time a segment is hit, the corresponding light will shut off.
- The illustration on the next page shows what targets each player must hit.

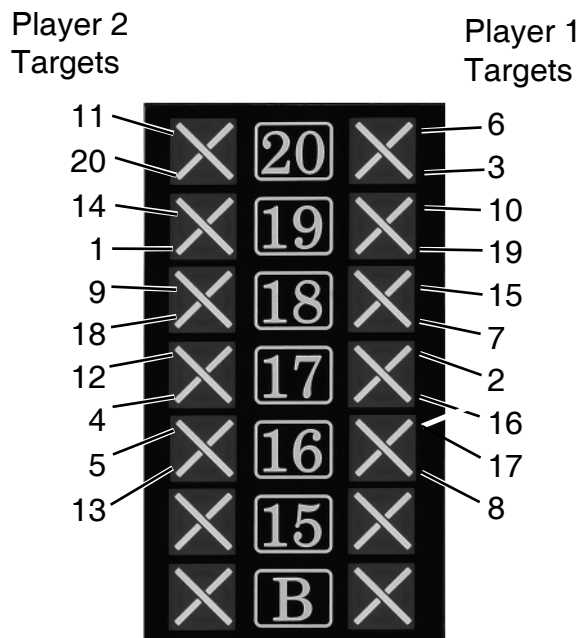

**G34 Cat & Mouse**

Refer to the section “Read First - Operation”.

**Playing the Game**

To win: If the mouse makes it all the way around the board back to the double 20, the mouse wins the game. If the cat hits the double segment that the mouse is on, the cat has caught the mouse and has won the game.

- This is a very challenging 2-player game that is best suited for players of advanced skill. One player will play the role of the cat and the other will be the mouse. The object of the game is for the mouse to get back to his hole before being caught by the cat.
- The mouse starts first from the “20” segment and proceeds counter-clockwise (to the left) around the dartboard.
- For the mouse to advance he must hit the double 20 followed by the single 20. This does not need to be in the same round. After the single 20 the next target will be the double 5 followed by the single 5. This continues counter-clockwise (to the left) around the board.
- The cat starts back at the “18” segment and proceeds counter-clockwise (to the left) around the dartboard to catch the mouse by hitting doubles only of each segment.
- The Players Score Display will show what number and segment you need to hit.

## 90-DAY LIMITED WARRANTY

The Manufacturer warrants to the original retail purchaser that this product is free from defects in material and workmanship under normal use and conditions for a period of ninety (90) days from the date of original purchase. The Manufacturer's liability is limited to the repair or replacement, at its option, of any defective product and shall not include any liability for indirect, incidental or consequential damages of any kind.

Should this product become defective due to material or workmanship within the warranty period, contact our Customer Service Department. This warranty is not transferable and does not cover normal wear and tear or damage caused by improper usage, negligence, misuse, abuse, transportation damage, acts of nature, or accident (including failure to follow the instructions in this manual). It does not cover expendable items such as batteries, light bulbs, fuses, accessories, cosmetic parts and other items that wear out due to normal usage, including felt covered areas of the playing surface. This warranty is also void if the product is disassembled and reassembled, damaged, modified from its original state, or used for other than indoor personal residential use (no commercial or rental applications). This warranty gives you specific legal rights, and you may have other rights which vary from state to state.

### **IF YOU HAVE A WARRANTY CLAIM, CALL US FIRST (8 - 4:30 CST):**

Please have your receipt and item number (found on the front cover) when you call.

#### ***GLD Products***

S84 W19093 Enterprise Drive

Muskego, WI 53150 USA

1-800-225-7593

Fax: 1-800-841-6944

Email: [gld@gldmfg.com](mailto:gld@gldmfg.com)

Web: [www.gldproducts.com](http://www.gldproducts.com)

**If you are instructed to return the product for service, you are responsible for shipping the unit at your expense to the above address in packaging that will protect against further damage. All warranty or repair requests require a Return Authorization Number prior to returning the item.**

## PRODUCT REGISTRATION

**Important:** The product registration form on page 41 must be completed and returned along with a copy of your receipt within 10 days of purchase to validate your warranty.

On-line registration is also available.

Go to <http://www.gldproducts.com/index.php/registration> or click on this link. Follow the on-line instructions.

This page left intentionally blank.



# REGISTER YOUR PRODUCT

Place postage here

Complete this form, include a copy of your receipt, fold, tape (do not staple) and return within 10 days of purchase. This protects your warranty and will help us develop new products!

Cut here.

**GLD Products**  
Warranty Department  
S84 W19093 Enterprise Drive  
Muskego, WI 53150 USA

Fold here second.



[www.gldproducts.com](http://www.gldproducts.com)

- |                       |                            |
|-----------------------|----------------------------|
| GAME TABLES           | HOME CASINO                |
| GAMES AND ACCESSORIES | BILLIARD CUES              |
| BILLIARD ACCESSORIES  | DARTBOARDS                 |
| SOFT-TIP DARTS        | STEEL-TIP DARTS            |
| FLIGHTS AND SHAFTS    | DART CASES AND ACCESSORIES |

Fold here first.

Name	Date of Purchase
Address	Phone-Day
City	Phone-Evening
State                      Zip	Email
Purchase Price:	Item: <b>42-1053 Mercury Electronic Dartboard</b>
Store Name:	

**Remember to attach a copy of your receipt.**

This page left intentionally blank.



[www.gldproducts.com](http://www.gldproducts.com)

**GAME TABLES**

**HOME CASINO**

**GAMES AND ACCESSORIES**

**BILLIARD CUES**

**BILLIARD ACCESSORIES**

**DARTBOARDS**

**SOFT-TIP DARTS**

**STEEL-TIP DARTS**

**FLIGHTS AND SHAFTS**

**DART CASES AND ACCESSORIES**



**PROUD MANUFACTURER OF**



*Yesterday's games for today's families!*  
by GLD Products

S84 W19093 Enterprise Drive • Muskego, WI 53150 USA  
262.679.8730 or 1.800.225.7593 tele  
262.679.8738 or 1.800.841.6944 fax  
Email: [gld@gldmfg.com](mailto:gld@gldmfg.com)  
[www.gldproducts.com](http://www.gldproducts.com)

<b>Game</b>	<b>Name</b>	<b>Optional Team Play</b>	<b>Players</b>	<b>In/Out Single/DBL/Master</b>	<b>Options</b>
G01	301 (501, 601, 701, 801, 901)	Yes	1-8	Yes	6
G02	Cricket (and No-Score Cricket)	Yes	1-8	N/A	2
G03	Scram Cricket	No	1-2	N/A	N/A
G04	Cut-Throat Cricket	Yes	1-8	N/A	N/A
G05	English Cricket	No	1-2	N/A	N/A
G06	Advanced Cricket	Yes	1-8	N/A	N/A
G07	Shooter	Yes	1-8	N/A	7
G08	Big Six	Yes	1-8	N/A	5
G09	Overs	Yes	1-8	N/A	5
G10	Unders	Yes	1-8	N/A	5
G11	Count-Up	Yes	1-8	Yes	8
G12	High Score	Yes	1-8	Yes	12
G13	Round-The-Clock	Yes	1-8	N/A	12
G14	Killer	Yes	1-8	N/A	11
G15	Double Down	Yes	1-8	N/A	N/A
G16	Forty One	Yes	1-8	N/A	N/A
G17	All Fives	Yes	1-8	N/A	5
G18	Shanghai	Yes	1-8	N/A	8
G19	Golf	Yes	1-8	N/A	10
G20	Football	Yes	1-8	N/A	N/A
G21	Baseball	Yes	1-8	N/A	4
G22	Steeplechase	Yes	1-8	N/A	N/A
G23	Bowling	Yes	1-8	N/A	6
G24	Car Rallying	Yes	1-8	N/A	N/A
G25	Shove A Penny	Yes	1-8	N/A	N/A
G26	Nine-Dart Century	Yes	1-8	Yes	N/A
G27	Green Vs. Red	No	1-2	N/A	N/A
G28	Gold Hunting	Yes	1-8	N/A	12
G29	Elimination	Yes	1-8	N/A	3
G30	Horseshoes	No	1-2	N/A	11
G31	Battleground	No	1-2	N/A	4
G32	Advanced Battleground	No	1-2	N/A	N/A
G33	Paintball	No	1-2	N/A	3
G34	Cat & Mouse	No	1-2	N/A	N/A

Single In/Single Out	The game is started and ended by hitting any segment
Double In/Single Out	A double must be hit to start scoring. Any segment may be hit to end the game.
Single In/ Double Out	Any segment may be hit to start the game. A double must be hit to end the game
Double In/Double Out	A double must be hit to start scoring and to end the game.
Single In/Master Out	Any segment may be hit to start the game. A double or triple is required to finish the game.
Double In/Master Out	A double must be hit to start scoring. A double or triple is required to finish the game.

<b>Team Options</b>	
2 Teams	2 Players On Each Team
3 Teams	2 Players On Each Team
4 Teams	2 Players On Each Team

<b>I MATCH Skill Levels</b>	
Level 1 (C1)	Professional
Level 2 (C2)	Advanced
Level 3 (C3)	Intermediate
Level 4 (C4)	Novice
Level 5 (C5)	Beginners