





# HEXAGON GALVANIZED STEEL RAISED GARDEN BED

Read the assembly instructions carefully and follow the care instructions. Save this document for future reference.  
**Assemble on a soft, clean surface to avoid scratching or damaging the finish.**

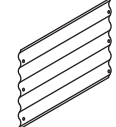
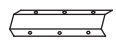

Inspect packaging to ensure all parts are accounted for before disposing of packing materials.

**! WARNING !**  
**CHOKING HAZARD** — This item contains small parts that can be swallowed. Keep children away during assembly.

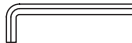
No.	PARTS	QTY.
A	 Side Panel	6
B	 Corner	6
C	 Corner Cap	12
D	 M6 x 12mm Bolt	36
E	 Nut	36
F	 Hex Key	1

## ! HELPFUL HINT

Do not fully tighten hardware until the entire unit is loosely assembled. If hardware is tightened too soon, mounting holes may not align and parts may not easily fit together.

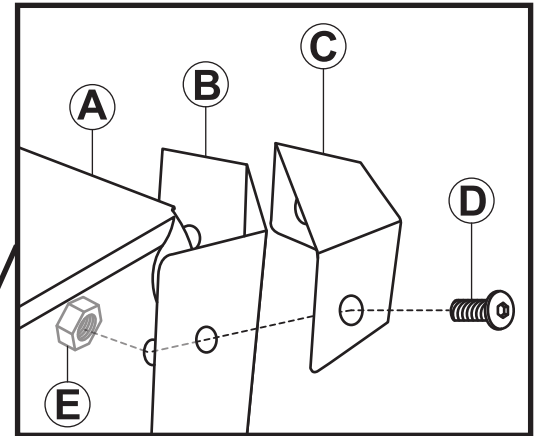

## ASSEMBLY

**NOTE:** Install side panels with the rolled edge facing outward.

1. Align the holes of Side Panel (A), Corner (B), and Corner Cap (C) on the top and bottom of the unit. Loosely secure each corner by hand-tightening 6x Bolt (D) and Nut (E).
2. Repeat Step 1 to connect the remaining components.
3. Once all components have been loosely assembled, tighten the hardware using Hex Key (F).

Any modification to the product or failure to follow recommended care will void the product warranty.