

OUTERCLÉ FEZBRICK

USAGE	Y / N
freeze/thaw	N
slip resistant	Y
UV resistant	Y
heat resistant	Y
radiant heating	Y
exterior wall	Y*
exterior floor	Y*
light residential traffic	Y
heavy residential traffic	Y
light commercial traffic	Y
heavy commercial traffic	N
industrial traffic	N
fountain	N
fountain waterlines	N
pool	N
pool waterlines	N
shower floors	Y*
shower walls	Y*
stove backsplash	Y*
sink backsplash	Y*
fire pit surround	Y
pizza oven surround	Y
grout joint	1/16"

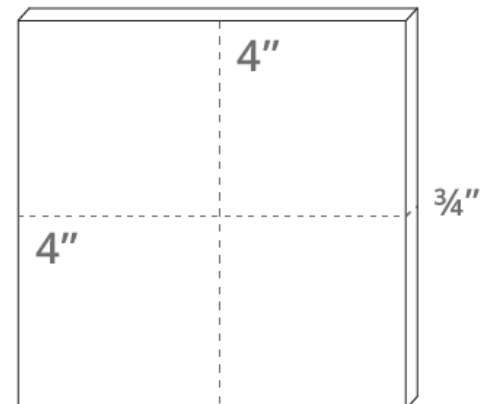
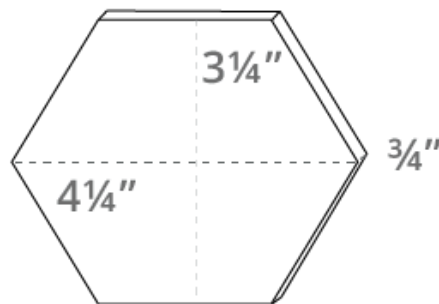
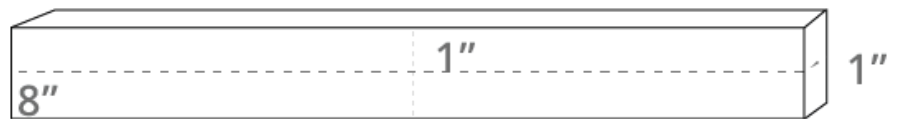
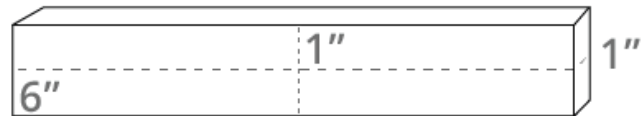

Standard thickness for FezBrick is 3/8".

Please note all dimensions are nominal and can vary +/- 1/8".

* There are specific installation requirements for this usage. Please refer to the "Installation Areas" section below and discuss with your installer.

FEZBRICK

What's in our tile: FezBrick is a tile that has retained its ancient tile making process and, therefore, has all the hand-hewn qualities that have become synonymous with it. Essentially, a glazed terracotta tile, hand-crafted, olive-pit fired and hand chiseled to size, FezBrick is a testament of ancient tile craft. If your order doesn't contain tiles with pits, cracks, iron spots, shade/size variations and chipped edges—it's not FezBrick.

Due to the handmade craftsmanship of our tiles and the variety of materials used, there will be degrees of variation in color, shade, size and texture across production lots or batches. This means that your sample may not be a perfect match with your actual order, and that your add-on order may not be a perfect match to either. **This is the beauty of artisanal tile!**

INSPECTING YOUR SHIPMENT

- **WHAT TO EXPECT** – FezBrick tiles are handcrafted, wood-fired terracotta with inherent variations in color, surface marks and texture as well as occasional crazing, pitting, and iron spots. ALSO - Dust and shipping residue are to be expected and should be cleaned prior to installing.
- **BLEND BLEND BLEND** - Due to the natural materials and production process of FezBrick tiles, there will be degrees of variation in color, shade, and size in your order. Therefore, it is important to blend the tiles from all boxes once they arrive and place them in their installation area to ensure you have the layout you want before installing.
- **ORDER EXTRA!** - Industry standard suggests adding at least 20% overage due to tile cuts, potential shipping breakage, or future repairs. Please note that due to the production process including the firing methods and raw materials used to create glazed clay tiles, your order of FezBrick will have a percentage of tiles greater than 15% with cracks, iron spots, crazing, chipped edges, and pitting. If these features do not fit your project's needs, we recommend ordering 20-30% overage. This will allow your contractor to cherry-pick the tiles most desirable for your project.
- **SHIPMENTS ARE SUBJECT TO WEATHER** – Tiles may be exposed to moisture and/or condensation during production or shipping which may affect the color of the tiles once received. Setting the tiles out to dry prior to installation will return the color to normal. Do not install tiles until fully dried.

INSTALLATION FYIs

- **GENERAL GUIDELINES, NOT INSTRUCTIONS** - OUTERclé offers general information about our tiles and their unique qualities and usages. Proper installation will only be attained if you have selected a seasoned installer with years of experience with artisan tiles. Any installer without artisan tile experience will not know how to install OUTERclé tiles and will likely result in failed installations.
- **EXTERIOR INSTALLATIONS HAVE UNIQUE CHALLENGES** - Exterior installations are subject to sun, rain, snow, changes in temperature, and other environmental factors. It is critical that your substrate, mortar, tile, grout, and sealant work together as a system to help your installation withstand the elements. Expansion joints are crucial to the success of any installation, especially exterior ones. Please consult your project architect, designer, structural engineer, manufacturer of installation materials, and installer for best results.
- Due to the environmental factors tiles face in outdoor installations, do not expect your tiles to look the same on day two as they did on day one.
- **INSTALLATION DEEMS ACCEPTANCE OF YOUR ORDER** - If you are not 100% sure of your tiles- DO NOT INSTALL THEM. As is standard in the tile industry and with all construction materials, installation deems acceptance of materials. Do not install if there are visible issues. If you have any doubts or are unsure of what qualifies as a visible issue for the tile you are installing, please reach out to us PRIOR to installation. Our tiles are subject to variations in color, texture, size, and finish. Misuse by contractor or end-user including but not limited to negligence, physical and/or chemical abuse, as well as order shortages ARE NOT an OUTERclé responsibility and therefore, not covered by OUTERclé's warranty.
- **TILE IS A MATERIAL. INSTALLATION ERRORS ARE NOT THE FAULT OF THE MATERIAL** – Tile is a material. Tile is merely the surface of your construction. Installation problems will arise from inexperienced artisan tile installers, substrate, or construction engineering and/or installation issues. Please refer to your project architect, structural engineer and/or installer for best results.
- **PLEASE CONFIRM YOUR LANDSCAPE INSTALLER'S LEVEL OF ARTISAN TILE EXPERIENCE** - We strongly suggest choosing installers who have shown their commitment to their craft and remained current with the latest methods and materials. We suggest requiring references and a portfolio along with a bid or estimate to ensure the installer has successfully completed work of similar size, scope, and complexity. Your installation will only be as good as your installer.

- **REQUIRE YOUR INSTALLER PERFORM A “DRY RUN” BEFORE BEGINNING YOUR INSTALLATION**
 - Before installing, make sure to lay out and blend ALL BOXES of your tiles so that your variations in color, and tiles that bear chips and pits are artfully placed as you would like. OUTERclé selects our tiles for their hand-hewn qualities and their inherent surface and color variations, which include pits, cracks, and chipping. The best placement of these nuances throughout your installation must be guided by you and/or your design professional to realize the best possible blend of your shipment of our limited-availability tiles. Your installation is only as good as your DRY RUN.

- **DO NOT USE TAPE, BLUE TAPE, OR OTHER TAPE** - Do not use blue tape or other construction tape during product installation. We cannot guarantee that the tape will not erode or damage our products.

- **WAIT UNTIL YOUR PROJECT IS COMPLETE BEFORE INSTALLING YOUR TILES** - Install the tiles as late as possible in the project to minimize the risk of damaging the tile.

- **REQUIRE MOCK-UP BOARDS** – Your next step to ensure your tiles will be organized properly and your grout joint size and color, as well as your sealant, are done to your design professional’s specifications- we urge you to require your installer create mock-up boards prior to your installation. This is a STANDARD PRACTICE for seasoned installers as it enables the end-user and their design professional to test all the tile layouts in mock-up form and, also will allow for the mock-up boards to be examined in the space and lighting in which the tiles will be used. Before beginning the mock-up boards- make sure to FIRST do your above-recommended DRY RUN and lay out and blend your tiles as described in that section.

- **“FINAL FINISH” – WHAT IT IS AND WHY MAY YOUR PROJECT REQUIRES THIS?** - If you plan to install your tile prior to the installation of cabinets, fixtures, etc., you’ll need to refinish the tile after those other features are installed in a step we call the “final finish.” In this step, your contractor should replace any broken or chipped tiles caused by construction damage, scuffing, or any deterioration of the tile surface. They should also hire a professional refinisher for the final refinishing of your tile installation. (*NOTE – Another benefit is that shipping refinishing can alleviate common shipping imperfections.). Make sure to account for this final step in your project timeline and budget.

- **TCNA and ANSI** - Please refer to the current edition of the TCNA Handbook for best installation results.

INSTALLATION AREAS

- FezBrick tiles are not freeze/thaw rated.
- FezBrick tiles are UV resistant.
- FezBrick tiles are heat resistant and can be used on fire pit and pizza oven surrounds.
- FezBrick tiles can be used on exterior walls. In cold-weather areas there must be flashing or roofing overhead and the tiles must be sealed with a water-repellent sealer (Miracle 511 Porous Plus, for example).
- FezBrick tiles are slip resistant and can be used on exterior floors. In cold-weather areas, they must be installed above-grade on covered decks or verandas and sealed with a water-repellent sealer (Miracle 511 Porous Plus, for example).
- FezBrick tiles are not suitable for pools, fountains, or their water lines.
- FezBrick tiles are suitable for use on shower floors and walls with the application of a penetrating water-repellent sealer.
- FezBrick tiles can be used as a stove backsplash. Please consult with your installer to see if a range splash is required for your installation.
- FezBrick tiles are suitable as a sink backsplash with the application of a penetrating sealer.
- FezBrick tiles are radiant heating compatible.

MORTAR & GROUT

- OUTERclé recommends a $\frac{1}{16}$ " grout joint with this collection.
- OUTERclé recommends using mortar and unsanded cementitious grout that comply with the ANSI A118 and/or ISO 13007 classifications suitable for your project. Please consult with your installation professional to make these determinations.

- Grout color selection is always up to our client and/or their design professional. However, OUTERclé is often asked for our opinion on best grout selections for our tiles. And due to the large array of grout colors that are now available, OUTERclé would like to offer this general guideline on a grout color selection for any of your OUTERclé tiles.
 - First, have your contractor complete your tile installation, except for the grout portion.
 - Next, ask your contractor to bring ALL grout color charts from his preferred grout manufacturer for your review.
 - Lastly, choose a time of day when you are most pleased with the lighting in your space (either natural lighting, installed lighting or a blend of both). During that lighting and time of day, select the grout color that best matches your tile selection.

 - If you are working with highly color-variegated tiles or a combination of tiles, we recommend that you follow the above recommendations—but match your grout to the color in your installation that you would like to accentuate.

 - We do not generally recommend using a contrasting grout color with FezBrick, as it will highlight the thin hairline cracks/crazing found on the tiles, and fill in any pits, and/or chips. If you choose to use a contrasting grout (i.e. white grout with black tile) please order 20-30% overage to cherry-pick the tile of the imperfections that are standard to FezBrick. Additionally, you must make sure to apply Stonetech Heavy Duty Sealer from Laticrete as a pre-grout treatment to minimize the possibility of the contrasting grout curing in the inherent hairline cracks, pits, and/or chips.

 - If your contractor is having any issues or questions regarding mortar or grout, please reach out to the manufacturer. They are the best and fastest line of contact.
-

SEALING, MAINTENANCE, AND CARE

- Please follow Laticrete's [Sealing, Maintenance, and Care Guide](#) for more guidance on cleaning, maintaining, and caring for your tile installation.

- **If you have any questions regarding Laticrete products or how to use them, please contact Laticrete directly by phone: 1-800-243-4788 X 1235.**

ADDITIONAL SPECIFICATIONS

AVERAGE COEFFICIENT OF FRICTION (DCOF ACUTEST)

“Wet Dynamic Coefficient of Friction” (DCOF) / Average 0.80

“Wet Dynamic Coefficient of Friction” is a test of a tile’s slip-resistance in wet conditions. For outdoor installations in wet areas, OUTERclé recommends choosing a tile with a DCOF \geq 0.60. This score should be used together with other information when deciding if a tile is suitable for a particular area, wet or not.

Please note that the application of a sealant may help increase slip resistance.

FREEZE/THAW RESISTANCE (ASTM C1026)

FezBrick tiles are not freeze/thaw resistant.

The Freeze/Thaw resistance test is a guide for choosing tiles suitable to environments where freezing and thawing can occur.

WATER ABSORPTION (ASTM C373)

Avg. 21.9%; non-vitreous.

The water absorption test determines how much a tile absorbs when immersed in water. A lower number generally means a tile is better suited for outdoor installations.

Please note that application of a sealant may decrease a tile’s water absorption.

ACID RESISTANCE

FezBrick tiles are not resistant to acids and only mild, pH neutral cleaners should be used.

SOLAR REFLECTANCE INDEX (ASTM E1980)

Solar Reflectance Index: testing has not yet been completed

This test indicates how hot a tile is likely to become when solar radiation is present on the surface. The higher the score, the greater the tile's capacity to reflect and release heat from the sun.

LEED Credit for Heat Island Reduction requires the use of outdoor pavers achieving an overall SRI score of at least 29 for the entire project.

COLOR, TEXTURE AND SIZE VARIATION

Color variation: level 2 - slight

Texture variation: level 3 - medium

Size variation: level 3 - heavy

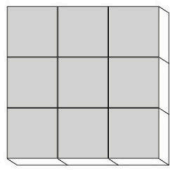
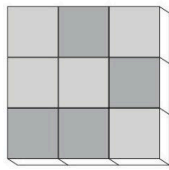
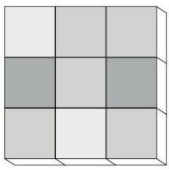
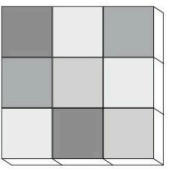
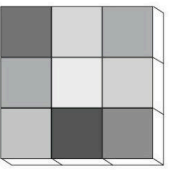
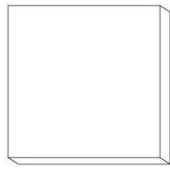
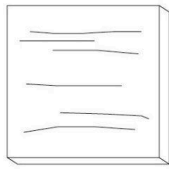
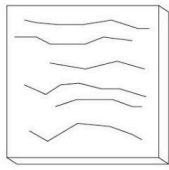
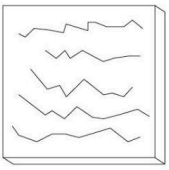
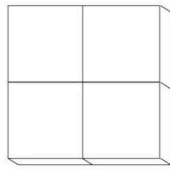
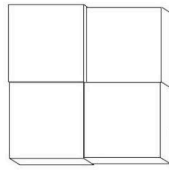
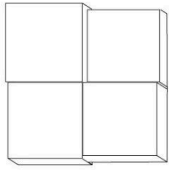
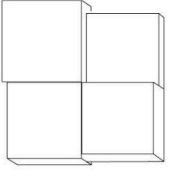
CATEGORY	LEVEL 1	LEVEL 2	LEVEL 3	LEVEL 4	LEVEL 5
COLOR VARIATION	 <p>low</p>	 <p>slight</p>	 <p>medium</p>	 <p>heavy</p>	 <p>extreme</p>
TEXTURE VARIATION	 <p>smooth</p>	 <p>slight</p>	 <p>medium</p>	 <p>heavy</p>	n/a
SIZE VARIATION	 <p>slight</p>	 <p>medium</p>	 <p>heavy</p>	 <p>extreme</p>	n/a

IMPERFECTIONS

Pits/Chips: level 2 - prevalent

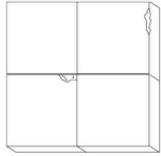
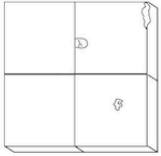
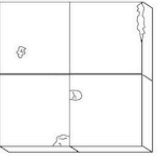
CATEGORY	LEVEL 1	LEVEL 2	LEVEL 3
PITS / CHIPS	 <p>will occur</p>	 <p>prevalent</p>	 <p>heavy</p>

Cracks: level 1 - will occur

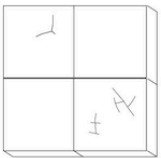
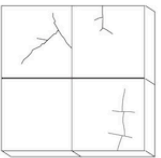
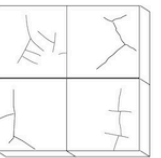
CATEGORY	LEVEL 1	LEVEL 2	LEVEL 3
CRACKS / CRAZING	 <p>will occur</p>	 <p>prevalent</p>	 <p>heavy</p>

PRODUCT DESCRIPTION

Handmade, unglazed terracotta tiles.

PRODUCT COMPONENTS

Clay, pigments

DIMENSIONS

Brindille	2.5 cm x 15.2 cm x 2.5 cm (1" x 6" x 1") / .12 kg per tile (.27 lbs)
Amulet	2.5 cm x 20.3 cm x 2.5 cm (1" x 8" x 1") / .29 kg per tile (.63 lbs)
Hex	10.8 cm x 7.6 cm x 1.9 cm (4 ¼" x 3 ¼" x ¾") / .22 kg per tile (.48 lbs)
Petite	10 cm x 10 cm (4" x 4" x ¾") / .25 kg per tile (.55 lbs)

* Please note all dimensions are nominal and can vary +/- ⅛".

LEED CREDITS

The product is an inherently non-emitting source of VOCs (stone, ceramic, metals, powder-coated metals, plated or anodized metal, glass, cement, clay brick, and unfinished or untreated solid wood) and has no integral organic-based surface coatings, binders, or sealants.

FezBrick tiles are considered 'inherently non-emitting sources' under the Low-emitting Materials Credit of LEEDv4/v4.1. This is currently the only credit for our FezBrick tile that is eligible to be used toward LEED. 'Inherently non-emitting' means that these tile types have been shown to not contribute emissions to indoor environments and are therefore exempt from demonstrating compliance with CDPH v1.1-2010 or CDPH v1.2-2017.

Use of these tiles as Wall or Flooring materials should be entered in the LEED v4.1 low-emitting materials Calculator and identified as 'inherently non-emitting' in the Products Tab (Column L).

Disclosures for MR Credit Material Ingredient Disclosures under LEEDv4/v4.1, are not available at this time. We are exploring our disclosure options and have not established a timeline for completion.

Disclosures for MR Credit Environmental Product Declarations under LEEDv4/v4.1, are not available at this time. We are exploring our disclosure options and have not established a timeline for completion.

Contribution to MR Credit Material Sourcing under LEEDv4/v4.1, does not apply as there is no recycled content, no bio-based materials, no wood, no reused products included in our tile at this time. Extended producer responsibility programs are highly difficult to manage given the nature of end-of-use tile removal methods. *Tile can last hundreds of years but fashions often change, which is the dominant reason for its removal. We work hard to ensure our stone tiles can withstand the test of time while remaining timeless.*

RECYCLED CONTENT

There is currently no recycled content in our FezBrick tiles. See material sourcing disclosure above.

PERCENTAGE OF PRE-CONSUMER AND/OR POST-CONSUMER MATERIALS

There is currently no pre-consumer or post-consumer material content in our FezBrick tiles. See Material Sourcing disclosure above.

FIRE RATING

Typically, ceramic tile does not need to have fire rating testing performed. It is our understanding from TCNA that the explanation that ceramic is inorganic, inert, and typically free of materials that could burn or produce smoke is generally enough to satisfy a specifier and that testing is not necessary. Also, the temperatures observed in the testing are typically lower than the temperatures at which ceramic tiles are fired.

FezBrick is a ceramic tile and falls under the description, “because ceramic tile is non-flammable and does not produce smoke in a fire, it inherently meets the flame spread and smoke development requirements of Section 803 of the International Building Code (IBC) for interior wall and ceiling.

