

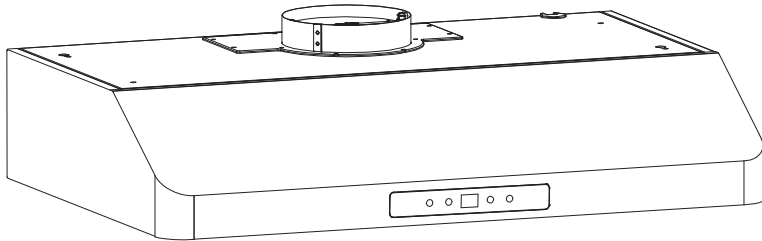

ITEM: RH-AZ0376TSS
RH-AZ0391TSS
ANZZI RANGE HOOD
INSTALLATION & OPERATION MANUAL
V1.1
02/07/2024



DON'T WAIT! REGISTER NOW!

Register your product within 90 days to ensure your product is recognized as an official purchase and is eligible for warranty coverage.

Mail in the completed registry card (Pg. 2) or register online at <https://register.anzzihome.com/register/>.



PRODUCT REGISTRATION*

IMPORTANT: Warranty will not be recognized unless product is registered.

We offer two options to register your product.

- 1. **Register online at <https://register.anzzihome.com/register/>** or Scan the QR code below. Registering online is fast, secure, and ensures we receive your information.

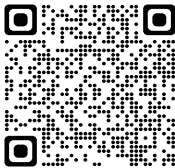

- 2. **Complete, cut out, and mail the registration card below.** Returning this registration card will ensure your product's warranty and allow us to process any warranty claims.

Mail the card to: 5701 NW 35 Avenue, Miami, FL 33142



Product Registration Card

Name Address

City State Zip

Phone Email

Date of Purchase Order or Purchase # SKU or Model #

Installer's Name Phone

I have read the Owner's Manual carefully and understand and agree that any installation, operation or maintenance of the product must be done strictly in accordance with instructions and guidelines contained in the owner's manual and installation guide.

Signature _____ Date _____

Need help? For technical support call 305-614-4070 or visit us at www.ANZZI.com

PRODUCT SIZE CHART

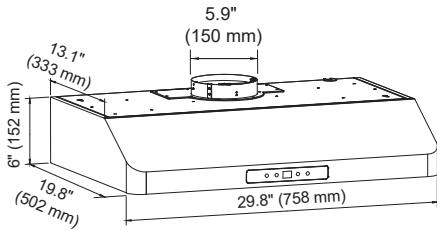

RH-AZ0376TSS

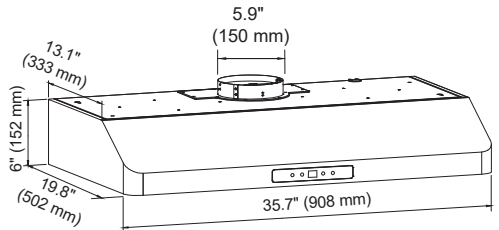

RH-AZ0391TSS

COMPONENTS

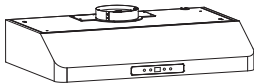

[01]



[02]

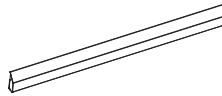

[03]



[04]



[05]

PART	Description	Qty.
01	Range Hood	1
02	Damper 3 1/4" X 10"	1
03	Oil Cup	1
04	#8 x 1.49" Screw	6
05	3/8" Anchor	2

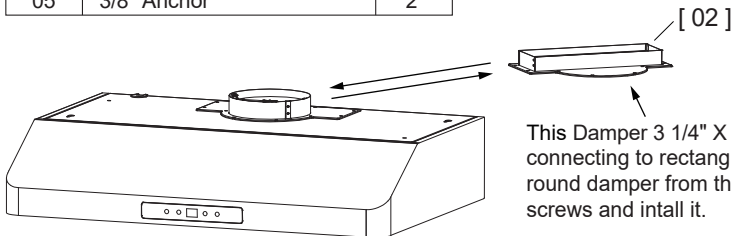

This Damper 3 1/4" X 10" [02] is for range hood connecting to rectangle ductwork. Remove the round damper from the range hood by loosening the screws and install it.

Thank you for purchasing an ANZZI Range Hood. Please read and follow the installation and operation instructions carefully, to ensure the long life and reliable operation of this appliance. Failure to do so could cause property damage, serious injury or death. Please keep this manual for future reference.

SAFETY PRECAUTIONS

READ AND SAVE THESE INSTRUCTIONS

WARNING

TO REDUCE THE RISK OF FIRE, ELECTRIC SHOCK, OR INJURY TO PERSONS, OBSERVE THE FOLLOWING:

- Use this unit only in the manner intended by the manufacturer. If you have questions, contact the manufacturer.
- Before servicing or cleaning unit, switch power off at service panel and lock the switch to prevent power from being switched on accidentally. When the switch cannot be locked, securely fasten a prominent warning device, such as a tag, to the service panel.
- Installation work and electrical wiring must be done by qualified person(s) in accordance with all applicable codes and standards, including fire-rated construction.
- When cutting or drilling into wall or ceiling, do not damage electrical wiring and other hidden utilities.
- This unit must be grounded.
- Sufficient air is needed for proper combustion and exhausting of gases through the flue (chimney) of fuel burning equipment to prevent back drafting. Follow the heating equipment manufacturer's guideline and safety standards such as those published by the National Fire Protection Association (NFPA), and the American Society for Heating, Refrigeration and Air Conditioning Engineers (ASHRAE), and the local code authorities.
- This product may have sharp edges. Be careful to avoid cuts and abrasions during installation or cleaning.
- To reduce the risk of fire, use only metal ductwork.
- Ducted fans must always be vented to the outdoors.

- **TO REDUCE THE RISK OF A RANGE TOP GREASE FIRE:**
 - a) Never leave surface units unattended at high settings. Boilovers cause smoking and greasy spillovers that may ignite. Heat oils slowly on low or medium settings.
 - b) Always turn hood ON when cooking at high heat or when flambeing food (i.e. Crepes Suzette, Cherries Jubilee, Peppercorn Beef Flambé).
 - c) Clean ventilating fans frequently. Grease should not be allowed to accumulate on fan or filter.
 - d) Use proper pan size. Always use cookware appropriate for the size of the surface element.

- **TO REDUCE THE RISK OF INJURY TO PERSONS IN THE EVENT OF A RANGE TOP GREASE FIRE, OBSERVE THE FOLLOWING (Based on "Kitchen Fire Safety Tips" published by NFPA.):**
 - a) **SOTHER FLAMES** with a close-fitting lid, cookie sheet, or metal tray, then turn off the burner. **BE CAREFUL TO PREVENT BURNS.** If the flames do not go out immediately, **EVACUATE AND CALL THE FIRE DEPARTMENT.**
 - b) **NEVER PICK UP A FLAMING PAN** – You may be burned.
 - c) **DO NOT USE WATER**, including wet dishcloths or towels – a violent steam explosion will result. Use an extinguisher **ONLY** if:
 - 1) You know you have a Class ABC extinguisher, and you already know how to operate it.
 - 2) The fire is small and contained in the area where it started.
 - 3) The fire department is being called.
 - 4) You can fight the fire with your back to an exit.

- Manufacturer will not be held liable for any damages resulting from incorrect or improper installation.
- Please read specification label on product for further information and requirements.

WARNING

- Improper grounding can result in a risk of electric shock. Consult a qualified electrician if the grounding instructions are not completely understood, or if doubt exists as to whether the appliance is properly grounded. Do not use an extension cord. If the power supply cord is too short, have a qualified electrician install an outlet near the appliance.
 - This appliance must be grounded. In the event of an electrical short-circuit, grounding reduces the risk of electric shock by providing an escape wire for the electric current. This appliance is equipped with a cord having a grounding wire with a grounding plug. The plug must be plugged into an outlet that is properly installed and grounded.
-

CAUTION

- For indoor use only.
 - For General Ventilating Use Only. Do Not Use To Exhaust Hazardous Or Explosive Materials And Vapors.
 - To avoid motor bearing damage and noisy and/or unbalanced impellers, keep drywall spray, construction dust, etc. off power unit.
 - The bottom of the hood **MUST NOT BE LESS** than 24" and at a maximum of 36" above cooktop for best capture of cooking impurities.
 - To Reduce The Risk Of Fire Or Electric Shock, Do Not Use This Fan With Any Solid-State Speed Control Device.
 - To reduce risk of fire and to properly exhaust air, be sure to duct air outside. Do not exhaust air into spaces within walls or ceilings or into attics, crawl spaces, or garages.
 - Be careful when installing the decorative flue and hood, they may have sharp edges.
 - Electrical installation must be in accordance with the National Electrical Code ANSI/NPA70-latest edition and/or local codes.
 - In certain circumstances electrical appliances may be a danger hazard.
 - a. Do not check the status of the filters while the cooker hood is operating.
 - b. Do not touch the light bulbs after appliance use.
 - c. Do not disconnect the appliance with wet hands.
 - There shall be adequate ventilation of the room when the range hood is used at the same time as appliances burning gas or other fuels.
 - Two installers are recommended because of the size of this hood.
 - The manufacturer reserves the right to make changes to its products when considered necessary and useful, without affecting the essential safety and operating characteristics.
 - The installer should leave these instructions with the consumer who should retain for local inspectors' use and for future reference.
-

NOTICE

- Follow all local electrical and safety codes, as well as the National Electrical Code (NEC) and the Occupational Safety and Health Act (OSH Act).
- Always disconnect the power source before working on the range hood.
- Make sure that the electric service supply voltage is AC 120V, 60Hz.
- Protect the power cord from sharp edges, oil, grease, hot surfaces, chemicals or other objects.
- Do not kink the power cord.
- Always turn the range hood on when cooking at high heat or when cooking flaming foods. Use high settings on the cooking range only when necessary.
- Deep fat fryer must be continuously monitored during use: overheated oil can burst into flame.
- The hood should not be used by children or persons not instructed in its correct use.
- Children don't recognize the risks of electrical appliances. Therefore they should use the appliance only under supervision of adults. Keep out of the reach of children.
- This appliance is not intended for use by persons (including children) with reduced physical, sensory or mental capabilities, or lack of experience and knowledge, unless they have been given supervision or instruction concerning use of the appliance by a person responsible for their safety. Children should be supervised to ensure that they do not play with the appliance.

TOOLS AND MATERIALS

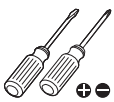

Screwdriver



Drill



3/8"(10mm)
Drill Bit

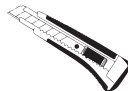

Utility knife



Gloves



Goggles



Duct tape

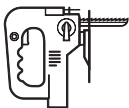

Jig saw

INSTALLATION GUIDELINES

⚠ CAUTION

1. Carefully inspect all items for damages upon delivery. Upon acceptance of items, owner assumes responsibility for its safe arrival.
2. Before installing your unit, test the range hood for proper functionality by plugging it into the wall and testing the fan and lights. Do not install this range hood if it has missing or broken parts. If the unit arrives damaged, contact ANZZI Customer Service for help.
3. Plug the range hood into a GFCI outlet.
4. Inspect duct work and wiring before proceeding with installation.
5. Improper grounding can result in a risk of electric shock. Consult a qualified electrician if doubt about whether the outlet is properly grounded. Do not use an extension cord. Install an outlet near the range hood if needed.
6. The ducting from this range hood to the outside of the building has a strong effect on the air flow, noise and energy use of the range hood. Use the shortest, straightest duct routing possible for best performance, and avoid installing the range hood with smaller ducts than recommended.
7. Use a roof cap or wall cap that has a built-in damper to reduce backdrafts.
8. To reduce the risk of fire, use only metal ductwork. 6" ductwork is needed for installation.
9. Old duct work should be cleaned or replaced, if necessary, to avoid the possibility of a grease fire or other hazard. Check all joints on duct work to ensure proper connection; all joints should be properly taped/secured.
10. You may need the help of a second person to install this range hood.

INSTALLATION

⚠ **WARNING** - Shut down power supply at breaker box before starting installation.

Step 1

1. Decide where the ductwork will run between the hood and the outside.
2. A straight, short duct run will allow the hood to perform most efficiently.
3. Long duct runs, elbows and transitions will reduce the performance of the hood. Use as few of them as possible. Larger ducting may be required for best performance with longer duct runs.
4. Install wall cap or roof cap. Connect round metal ductwork to cap and work back towards the range hood location. Use duct tape to seal the joints between ductwork sections.

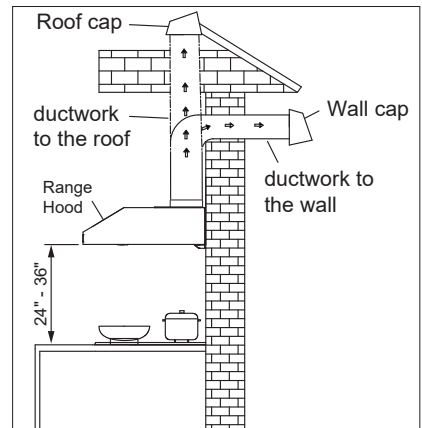

Fig 1

NOTE:

- Ducting is not provided with your ANZZI range hood. It's recommended to use solid ducting made of galvanized steel or another appropriate rigid metal ducting whenever possible for the lowest noise and highest flow.
- Do not use any reducers on ducting smaller than the appropriate diameter.
- Any existing or additional dampers should be inspected for proper operation.

INSTALLATION

Step 2

1. Cut openings on the board which is at the top of the **Range Hood [01]** according to Fig 2.a.
2. Remove the baffles from the **Range Hood [01]** by pulling down the metal latch tabs and tilting baffles downward to remove. (There are 2 baffles for RH-AZ0376TSS, 3 baffles for RH-AZ0391TSS) (Fig 2.b)
3. Position the **Range Hood [01]** to the wall and push to the **top board**. (Fig 2.d)
Note: The bottom of the hood **MUST NOT BE LESS** than 24" and at a maximum of 36" above cooktop.
4. Mark the screw holes from the inside of **Range Hood [01]** on the wall as figure shows. Remove the **Range Hood [01]**. (Fig 2.c)
5. Drill holes at locations according to Fig 2.e and insert **3/8" Anchors [05]**. (Fig 2.e)

Note: Make sure there is wood framing behind the screw holes. Anchors are for dry wall or cement wall. Drive screws directly into the wood framing or drill smaller pilot holes.

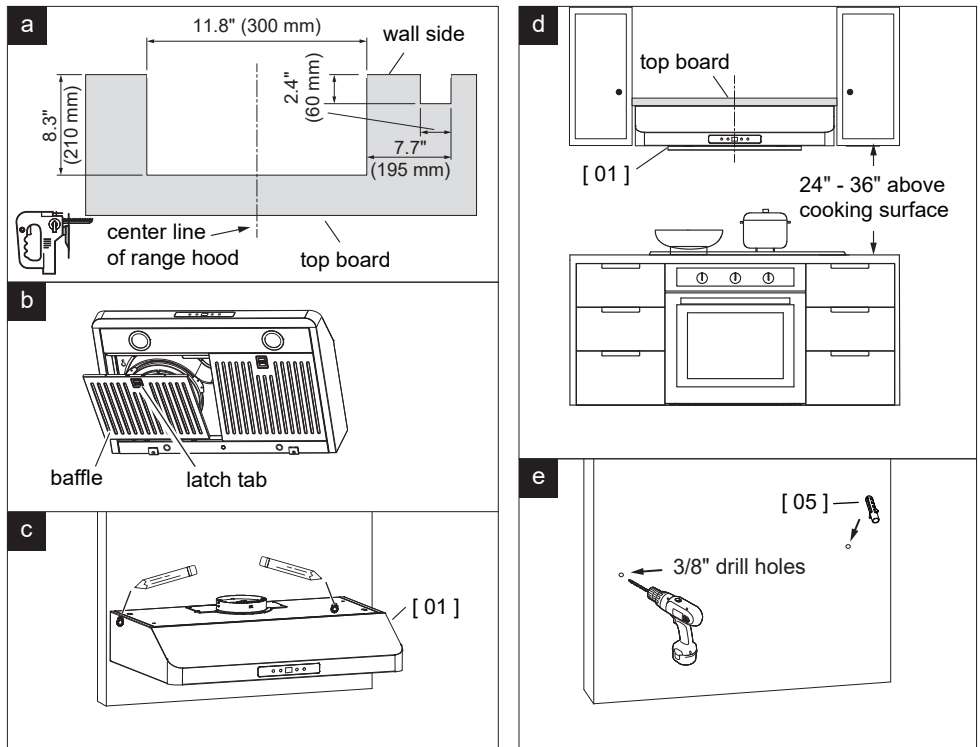

Fig 2

INSTALLATION

Step 3

1. Hold **Range Hood [01]** on the wall and close to the **top board**. (Fig 3)
2. Pull the ductwork through the **top board**. Secure your ducting connection to the **duct outlet** using **Duct tape** to hold it in place. Try to minimize the use of elbows. More elbows and longer runs will reduce the air suction. Use **Duct tape** to make all joints secure and air tight. (Fig 3)
3. Slide the power cord through the **top board** and connect the **Range Hood [01]** to the **GFCI outlet**.
4. Hold the **Range Hood [01]** on the wall.

Note: Make sure the dampers at the duct outlet of range hood can be opened and closed easily.

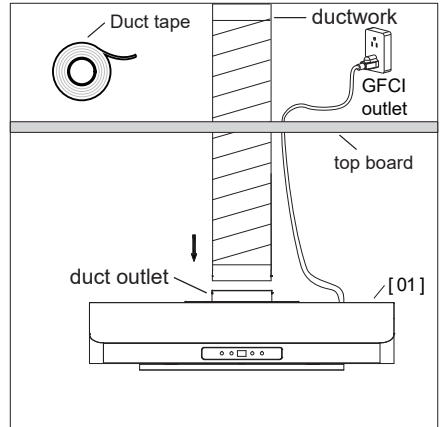

Fig 3

Step 4

1. Push the **Range Hood [01]** to **top board** and wall and secure with **#8 x 1.49" Screws [04]** from the inside. (Fig 4)

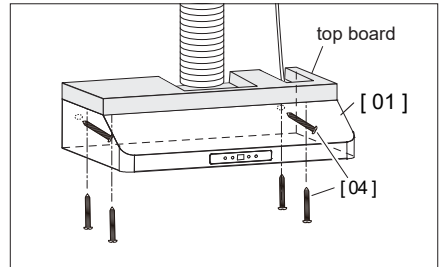

Fig 4

Step 5

1. Install the baffles back to the range hood. (Fig 5)
2. Slide the Oil Cup [03] from the front of the **Range Hood [01]** to finish the installation. (Fig 5)

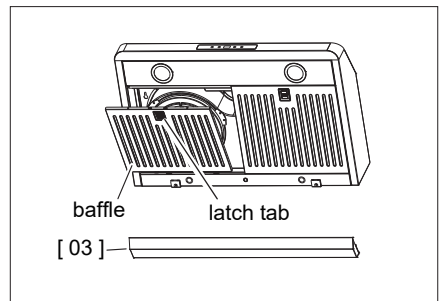











Fig 5

OPERATING INSTRUCTIONS

⚠ WARNING - This RANGE HOOD must be properly installed before it is used.

OPERATION OF CONTROLS

- Press  to turn the range hood on/off.
- Press  to turn the LED lights on/off.
- When the range hood is on, press  to reduce the air flow level, press  to increase the air flow level. There are 4 levels for this range hood.
- When the range hood is on, hold down  for 3 seconds to activate power-off delay timer. The  flashes during the delay countdown. After 3 minutes, the light and motor turn off automatically.
- Pressing  during countdown will turn off the range hood. Press  or  during countdown to end the countdown.

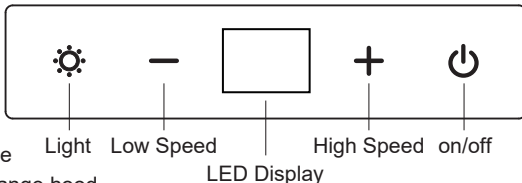

CLEANING AND MAINTENANCE

⚠ WARNING

Always disconnect the power source before working on the range hood.
Proper maintenance of the Range Hood will assure proper performance of the unit.

MOTOR

The motor is permanently lubricated and never needs oiling. If the motor bearings make excessive or unusual noise, replace the blower. It's important to replace with the exact same blower for optimal performance.

BAFFLE

The baffles and Oil Cup are washable and should be cleaned frequently. Use a warm dishwashing detergent solution. Remove baffles by pulling down on the metal latch tab. This will disengage the baffles from the hood. Tilt the baffles downward and remove. Slide Oil Cup forward to remove it.

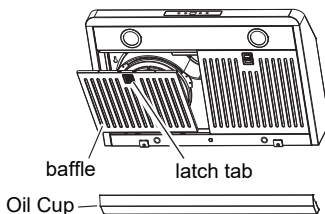

LED LIGHT

Replacement LED lights can be ordered by calling our customer support line at 305-614-4070.

Make sure the range hood is unplugged or turn OFF breaker.

1. Gently pull the defective bulb assembly straight out from the edge using a slotted screwdriver, and then disconnect the wires.
2. Connect the new LED bulb's wires and snap the new LED assembly into the housing hole.
3. Turn ON breaker/power and test the range hood for operation.

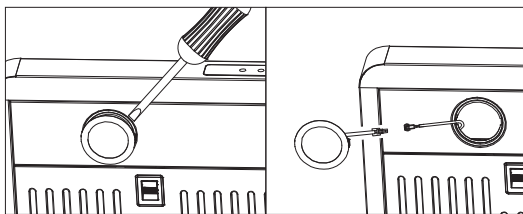

CLEANING AND MAINTENANCE

STAINLESS STEEL CLEANING

- Regularly wash with clean cloth or rag soaked with warm water and mild soap or liquid dish detergent.
- Always clean in the direction of original polish lines.
- Always rinse well with clear water (2 or 3 times) after cleaning. Wipe dry completely.
- You may also use a specialized household stainless steel cleaner.
- DON'T Use any steel or stainless steel wool or any other scrapers to remove stubborn dirt.
- DON'T use any harsh or abrasive cleansers.
- DON'T allow dirt to accumulate.
- DON'T allow plaster dust or any other construction residues to reach the hood. During construction/ renovation, cover the range hood to make sure no dust sticks to the stainless steel surface.
- DON'T use any cleaners that contain bleach, chloride, fluoride, iodide, bromide.
- DON'T use any combustible products for cleaning such as acetone, alcohol, ether, benzol, etc. .

TROUBLE SHOOTING

SYMPTOMS	POSSIBLE CAUSE	RECOMMENDED ACTIONS
Air is barely sucked in while the range hood is running.	The filter is clogged with grease.	Clean or replace the grease filter.
	The damper flaps can't be fully opened.	Remove the ductwork from the range hood and check the damper flaps.
	Too many elbows for the duct work or the duct work is too long.	Reduce the elbows to no more that 3 pieces. The length of the ductwork shouldn't be longer than 40'.
The range hood will not turn on.	Power is not adequately supplied.	Make sure your power supply is on.
The range hood is making a rattling noise.	The motor is loose.	Turn off the power and remove the filter and check that all screws are secure and tight around the motor.
	The duct work connection is loose.	Turn off the power to the unit and check that the ductwork connection to the outlet is tight. Add duct tape if necessary.
	Something is wrong with the damper.	Fix the damper. Replace it if needed.

CIRCUIT DIAGRAM

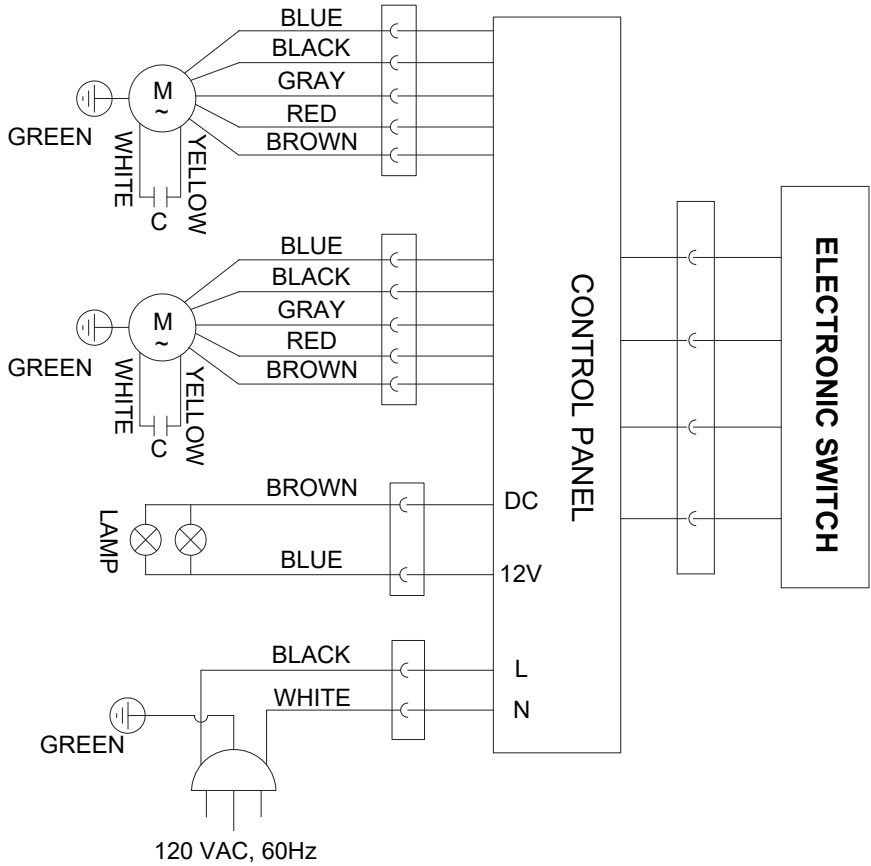

ANZZI®