

Talis S
Pot Filler, Wall-Mounted
 Finishes : **steel optic** Part no. : **04057860**



Description

Features

- Swivel range 180°
- Aerated spray
- Wall-mounted
- Flow: 2.5 GPM (9.5 L/Min)
- 90° ceramic valves
- 1/2" NPT
- California Low Lead / Section 116875 CHSC

Item details

List Price \$ 1,185.00

Compliance



Product image



Scale drawing

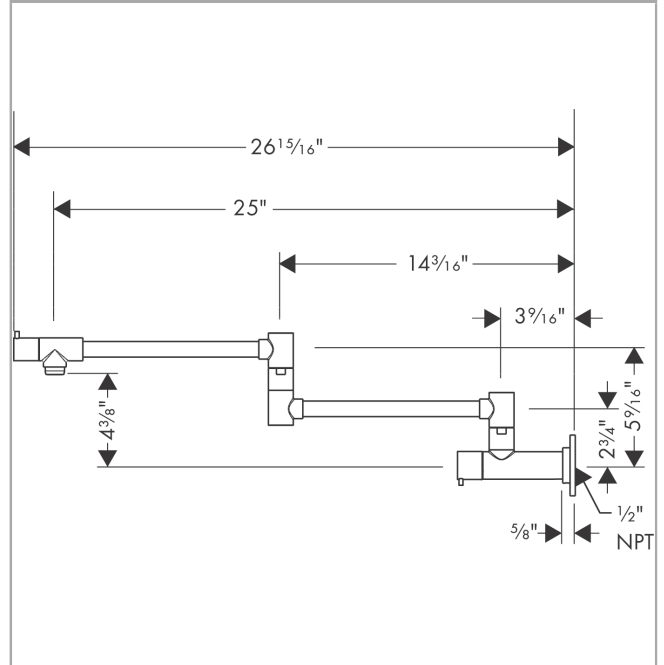

Talis S
Pot Filler, Wall-Mounted
 Finishes : **steel optic** Part no. : **04057860**



Exploded drawing

Year of production: >08/08

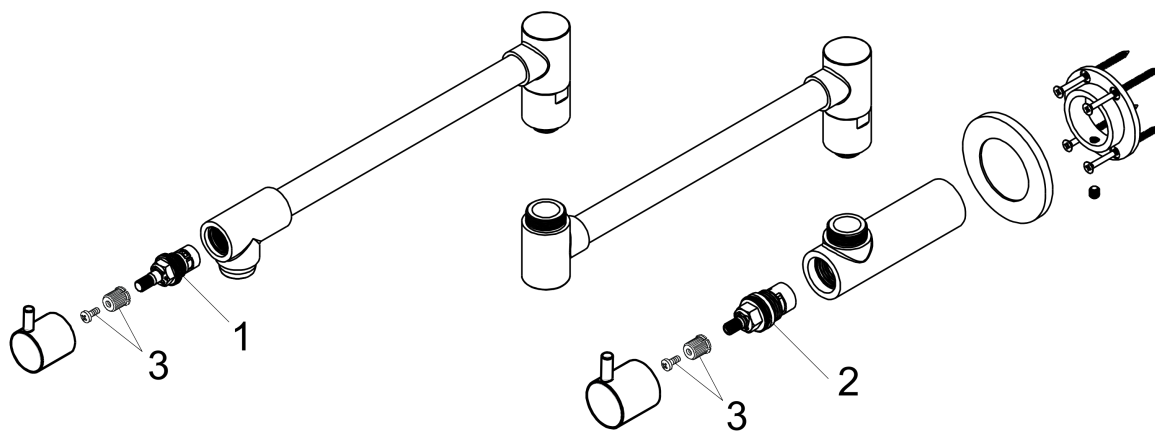

Talis S
Pot Filler, Wall-Mounted
 Finishes : **steel optic** Part no. : **04057860**



Spare parts list

Year of production: >08/08

Pos.	Description	Part no.	Price	PU
1	shut off unit	88789000	-	1
2	shut off unit	88790000	-	1
3	handle fixing set	98932000	-	1